

MORTAR FIRE DIRECTION PROCEDURES

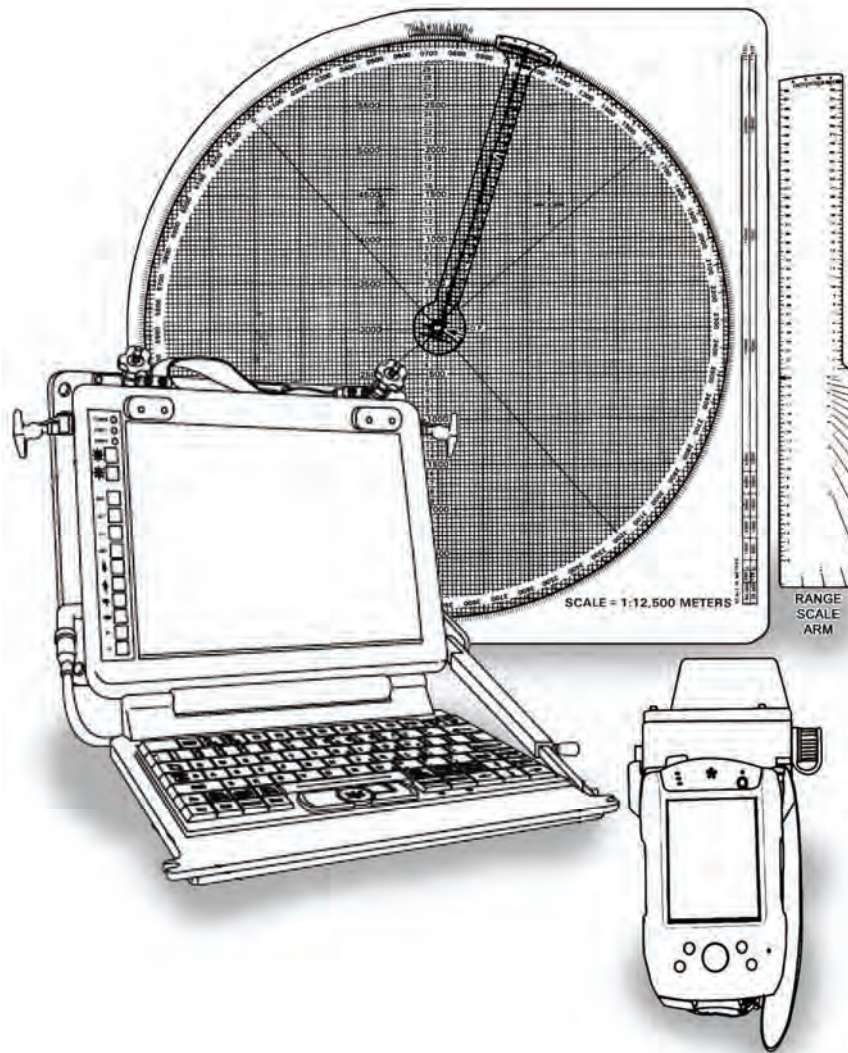

July 2008

DISTRIBUTION RESTRICTION: Approved for public release; distribution is unlimited.

HEADQUARTERS
DEPARTMENT OF THE ARMY

This publication is available at
Army Knowledge Online (www.us.army.mil) and
General Dennis J. Reimer Training and Doctrine
Digital Library at (www.train.army.mil).

Mortar Fire Direction Procedures

Contents

	Page
Preface.....	xix
Part One INTRODUCTION AND FUNDAMENTALS OF MORTAR FIRE CONTROL.....	1-1
Chapter 1 INTRODUCTION.....	1-1
Organization	1-1
General Doctrine	1-1
Indirect Fire Team	1-2
Mortar Positions.....	1-3
Missions and Fire Direction Control Procedures.....	1-4
Fire Control Systems.....	1-6
Chapter 2 FUNDAMENTALS OF MORTAR FIRE DIRECTION	2-1
Section I. Elements of Firing Data and Ballistics.....	2-1
Direction	2-1
Range	2-2
Vertical Interval.....	2-2
Distribution of Bursts	2-2
Interior Ballistics	2-2
Nature of Propellants and Projectile Movements.....	2-2
Standard Muzzle Velocity.....	2-3
Nonstandard Muzzle Velocity.....	2-3
Exterior Ballistics	2-4
Trajectory.....	2-4
Section II. Firing Tables	2-6
Purpose	2-6
Unit Corrections.....	2-6
Standard Range	2-7
Dispersion and Probability.....	2-9
Mean Point of Impact.....	2-10

DISTRIBUTION RESTRICTION: Approved for public release; distribution is unlimited.

***This publication supersedes FM 3-22.91, 18 January 2005.**

	Probable Error.....	2-12
	Section III. Fire Planning	2-14
	Terminology	2-14
	Target Considerations.....	2-16
	Support of Offensive Operations	2-17
	Support of Defensive Operations.....	2-18
	Fire Support Coordination Measures.....	2-19
	Company Fire Support Plan.....	2-20
	Battalion Fire Support Plan.....	2-22
	Section IV. Target Analysis and Attack	2-22
	Target Description.....	2-22
	Registration and Survey Control.....	2-23
	Size of Attack Area	2-23
	Maximum Rate of Fire.....	2-23
	Amount and Type of Ammunition.....	2-25
	Unit Selection	2-26
	Typical Targets and Methods of Attack	2-27
Part Two	FIRE DIRECTION CENTER	3-1
Chapter 3	INTRODUCTION	3-1
	Principles of Fire Direction.....	3-1
	Organization.....	3-1
	Personnel Duties.....	3-2
Chapter 4	MAJOR CONCERNS OF THE FIRE DIRECTION CENTER.....	4-1
	Types of Sheaves	4-1
	Computer's Record.....	4-3
	DA Form 2188-R (Data Sheet)	4-9
	DA Form 2188-1-R (LHMBC/MFCS Data Sheet)	4-14
	Angle T.....	4-17
	Firing Tables	4-19
	DA Form 3675-R (Ballistic Message)	4-22
	Computer Meteorological Message.....	4-36
	6400-Mil Meteorological Message	4-37
	Computation of Meteorological Corrections for Large Sector Capability.....	4-37
	Meteorological Corrections	4-40
Chapter 5	CALL FOR FIRE.....	5-1
	Introduction	5-1
	Observer Identification	5-1
	Warning Order	5-1
	Methods of Target Location	5-2

	Target Description	5-3
	Method of Engagement	5-3
	Methods of Fire and Control	5-4
	Message To Observer	5-6
	Call For Fire Format	5-7
	Authentication	5-8
Part Three	MORTAR BALLISTIC COMPUTER	6-1
Chapter 6	INTRODUCTION	6-1
	Description.....	6-1
	Audio Alarm	6-11
	Capabilities	6-12
	Memory Storage Capacity	6-13
Chapter 7	PREPARATION OF FIRE CONTROL EQUIPMENT.....	7-1
	Types of Data Entry	7-2
	Initialization	7-5
Chapter 8	TYPES OF MISSIONS	8-1
	Grid Mission Switch	8-1
	Shift Mission Switch.....	8-5
	Polar Mission Switch	8-8
	Technical Fire Control	8-11
	Sheaves.....	8-12
	Traversing Fire	8-13
	Searching Fire	8-20
	Illumination	8-21
	Coordinated Illumination.....	8-23
Chapter 9	SPECIAL PROCEDURES	9-1
	Registration and Sheaf Adjustment.....	9-1
	Mean Point of Impact Registration	9-4
	Radar Registration.....	9-6
	Final Protective Fires.....	9-8
	Immediate Smoke or Immediate Suppression	9-12
	Quick Smoke	9-13
	Special Keys and Functions	9-19
Chapter 10	DIGITAL DEVICE SUPPORT	10-1
	Application	10-1
	Communications.....	10-1

Part Four	M16 AND M19 PLOTTING BOARDS	11-1
Chapter 11	INTRODUCTION	11-1
	Capabilities.....	11-1
	M16 Plotting Board	11-2
	M19 Plotting Board	11-4
Chapter 12	PREPARATION OF FIRE CONTROL EQUIPMENT	12-1
	Observed Firing Charts.....	12-1
	Modified-Observed Firing Chart.....	12-13
	Transfer of Targets	12-19
	Deflection Conversion Table.....	12-22
	Grid Mission	12-23
	Shift from a Known Point Mission	12-23
	Polar Plot Mission	12-24
Chapter 13	TYPES OF MISSIONS.....	13-1
	Traversing Fire.....	13-1
	Searching Fire.....	13-8
	Illumination	13-12
Chapter 14	SPECIAL CONSIDERATIONS.....	14-1
	Registration and Sheaf Adjustment	14-1
	Mean Point of Impact Registration.....	14-13
	Vertical Interval Correction Factors	14-17
	Radar Registration	14-19
	Final Protective Fires	14-21
Part Five	MORTAR FIRE CONTROL SYSTEM	15-1
Chapter 15	INTRODUCTION	15-1
	Section I. Initialization and Configuration	15-1
	Description	15-1
	Capabilities.....	15-8
	Soldier Graphic User Interface	15-9
	Data Initialization and System Configuration.....	15-13
	Section II. Additional Functions	15-26
	Ammunition/Status Function	15-27
	Meteorological Data Screen.....	15-32
	Target/Known Point Screen.....	15-36
	Safety Fan Screen	15-39
	Check Fire.....	15-40
	Plain Text Messages.....	15-41
	Alerts Function	15-44

Chapter 16	FIRE MISSIONS.....	16-1
	Section I. Parts of a Standard Fire Mission	16-1
	Standard Fire Mission Procedures.....	16-1
	Sequence of Actions from the Initial Call For Fire to the End of Mission.....	16-1
	Digital and Manual Fire Mission Tabs and Screens.....	16-2
	Common Actions	16-4
	Section II. Basic Fire Missions.....	16-5
	Basic Digital Missions.....	16-5
	Manual Missions.....	16-16
	Section III. Special Missions	16-19
	Registration Point	16-20
	Target/Known Point.....	16-22
	Illumination Mission	16-24
	Coordinated Illumination Mission	16-30
	Final Protective Fires.....	16-32
	Smoke Missions	16-43
Part Six	LIGHTWEIGHT HANDHELD MORTAR BALLISTIC COMPUTER	17-1
Chapter 17	INTRODUCTION.....	17-1
	Section I. Initialization and Configuration	17-1
	Description.....	17-1
	Capabilities	17-3
	Battery Life	17-4
	Graphic User Interface	17-4
	Startup	17-8
	Data Initialization and Configuration.....	17-9
	Meteorological Data.....	17-17
	Safety Fan	17-20
	Check Fire	17-22
	Section II. Communication	17-23
	Cable Connection	17-23
	Parameter Setup	17-24
	Set Up a Unit Address.....	17-26
	Edit a Unit Address.....	17-26
	Enable or Disable a Channel.....	17-27
	Send Status Screen.....	17-28
	Plain Text Messaging	17-28
	Section III. Global Positioning System.....	17-29
	Setup and Initialization	17-29
	Standby Mode	17-31
	Global Positioning System COMSEC Key	17-31
	Zeroizing the Global Positioning System Crypto Key.....	17-31

Chapter 18	FIRE MISSIONS	18-1
	Section I. Manual Fire Missions.....	18-1
	Grid Missions	18-2
	Shift From a Known Point Missions	18-12
	Polar Plot Missions	18-13
	Laser Polar Plot Missions	18-14
	Quick Fire Missions.....	18-15
	Direct Lay Missions.....	18-16
	Hipshoot Missions.....	18-17
	Targets/Known Points.....	18-21
	Section II. Digital Fire Missions	18-21
	Receipt of the Message	18-22
	Section III. Special Missions	18-33
	Registration Missions.....	18-34
	Illumination Missions.....	18-39
	Coordinated Illumination Missions	18-46
	Final Protective Fires	18-49
	Smoke Missions.....	18-61
	Search and Traverse Missions	18-74
Appendix A	MORTAR TRAINING STRATEGY	A-1
	General	A-1
	Training Evaluation	A-1
Appendix B	ICONS FOR THE MORTAR FIRE CONTROL SYSTEM.....	B-1
Appendix C	SAFETY PROCEDURES	C-1
	Surface Danger Zones.....	C-1
	Safety Diagram	C-4
Appendix D	FIELD-EXPEDIENT SURVEY TECHNIQUES	D-1
	Graphic Resection	D-1
	Hasty Survey.....	D-4
Appendix E	FIRE DIRECTION CENTER CERTIFICATION	E-1
	Section I. Conduct of the Program.....	E-1
	Eligible Personnel	E-1
	Qualification	E-1
	General Rules	E-2
	Section II. Certification	E-2
	M16/M19 Plotting Board Certification	E-2
	Mortar Fire Control System Certification.....	E-3
	Lightweight Handheld Mortar Ballistic Computer Certification	E-4
	Mortar Ballistic Computer Certification	E-5

Section III. Mortar Ballistic Computer Example Test	E-5
Situation A	E-6
Situation B	E-9
Situation C	E-11
Situation D	E-13
Situation E	E-19
Situation F	E-21
Situation G	E-23
Situation H	E-27
Situation I	E-31
Situation J	E-32
Situation K	E-34
Situation L	E-37
Situation M	E-39
Situation N	E-41
Situation O	E-44
Section IV. Plotting Board Test	E-46
Situation A	E-46
Situation B	E-47
Situation C	E-54
Appendix F ERROR MESSAGES	F-1
Characters	F-1
Messages, Explanations, and Actions	F-1
Glossary	Glossary-1
References	References-1
Index	Index-1

Figures

Figure 1-1. Indirect fire team.	1-2
Figure 2-1. Direction to the target.....	2-1
Figure 2-2. Elements of the trajectory.	2-5
Figure 2-3. Example of Firing Table 120-E-1.	2-6
Figure 2-4. Mean point of impact.....	2-10
Figure 2-5. Burst in elliptical pattern.....	2-10
Figure 2-6. A 100-percent rectangle.....	2-11
Figure 2-7. Dispersion rectangle.	2-11
Figure 2-8. One probable error.....	2-12
Figure 2-9. Range probability curve.	2-12
Figure 2-10. Probable error in deflection.....	2-13
Figure 2-11. Group of targets.	2-15
Figure 2-12. Series of targets.....	2-15

Figure 2-13. Final protective fires symbol..... 2-16

Figure 4-1. Example of completed DA Form 2399-R (Computer's Record)..... 4-3

Figure 4-2. Example of completed DA Form 2188-R (Data Sheet)..... 4-9

Figure 4-3. Example of completed DA Form 2188-1-R (LHMBC/MFCS Data Sheet)..... 4-14

Figure 4-4. Angle T between 400 and 1600 mils. 4-17

Figure 4-5. Angle T exceeding 499 mils. 4-18

Figure 4-6. Sample pages from firing tables for 60-mm mortar..... 4-20

Figure 4-7. Sample pages from firing tables for 81-mm mortar..... 4-21

Figure 4-8. Sample pages from firing tables for the 120-mm mortar..... 4-22

Figure 4-9. Six-character groups. 4-23

Figure 4-10. Example of completed DA Form 3675-R (Ballistic Message)..... 4-24

Figure 4-11. Example of completed DA Form 3675-R (Ballistic Message)..... 4-25

Figure 4-12. Line number and zone height relative to meteorological data plane. 4-27

Figure 4-13. Example of completed first seven lines for DA Form 3675-R (Ballistic Message)..... 4-28

Figure 4-14. Data guide for DA Form 2601-1-R (MET Data Correction Sheet for Mortars). 4-30

Figure 4-15. Example of completed DA Form 2601-1-R (MET Data Correction Sheet for Mortars). 4-31

Figure 4-16. Sample page from firing table for air temperature and density corrections. 4-32

Figure 4-17. Sample page from firing table for wind components..... 4-33

Figure 4-18. Sample pages from firing table for basic data and correction factors..... 4-34

Figure 4-19. Sample page from firing table for propellant temperature..... 4-35

Figure 4-20. Example of completed DA Form 2601-2-R (MET Data Correction Sheet 6400 mils [Mortars])..... 4-38

Figure 4-21. Example of completed DA Form 2601-2-R (MET Data Correction Sheet 6400 mils [Mortars]) for a full 6400-mil capacity..... 4-39

Figure 4-22. Initial meteorological message. 4-41

Figure 4-23. Second meteorological message. 4-42

Figure 4-24. Updated registration corrections, deflection..... 4-43

Figure 4-25. Updated registration corrections, range. 4-44

Figure 4-26. Deflection and range corrections. 4-45

Figure 4-27. Example for updating target data. 4-47

Figure 6-1. Mortar ballistic computer. 6-1

Figure 6-2. Initialization switches..... 6-2

Figure 6-3. Action switches..... 6-5

Figure 6-4. Alphanumeric and minus sign keys..... 6-6

Figure 6-5. Fire mission keys..... 6-7

Figure 6-6. Output switches..... 6-9

Figure 6-7. Display switches. 6-10

Figure 6-8. Light-emitting diode indicators..... 6-10

Figure 7-1. Mortar ballistic computer switch panel. 7-1

Figure 7-2. Declination diagram..... 7-4

Figure 8-1. Excerpt from example DA Form 2399-R (Computer's Record) with call for fire and FDC order completed. 8-14

Figure 8-2. Example of completed DA Form 2399-R (Computer's Record) for adjustment..... 8-15

Figure 8-3. Example situation chart number 1. 8-17

Figure 8-4. Example situation charts numbers 2 and 3. 8-17

Figure 8-5. Example situation charts numbers 4 and 5. 8-17

Figure 8-6. Example of deflection conversion table. 8-19

Figure 8-7. Range-lateral spread. 8-23

Figure 9-1. Determination of a spotting. 9-7

Figure 9-2. Fire direction center order. 9-18

Figure 11-1. Vernier scale. 11-2

Figure 11-2. M16 plotting board. 11-3

Figure 11-3. M19 plotting board. 11-4

Figure 12-1. Preparation of the plotting board. 12-2

Figure 12-2. Superimposition of referred deflection scale under the mounting azimuth. 12-3

Figure 12-3. Determination of the deflection. 12-3

Figure 12-4. Charge versus range chart. 12-4

Figure 12-5. Determination of charge..... 12-4

Figure 12-6. Charge zone and range. 12-5

Figure 12-7. Plotting of observer's correction. 12-6

Figure 12-8. Determination of deflection and range..... 12-7

Figure 12-9. Board updated. 12-8

Figure 12-10. Hollow cross with target number..... 12-8

Figure 12-11. Plotting of mortar position. 12-9

Figure 12-12. Plotting of first round. 12-10

Figure 12-13. Parallel-line plotting..... 12-11

Figure 12-14. Determination of range with edge of DA Form 2399-R (Computer's Record). 12-12

Figure 12-15. Grid intersection to represent pivot point..... 12-14

Figure 12-16. Superimposition of the grid. 12-15

Figure 12-17. Plotting of a mortar position. 12-16

Figure 12-18. First plot. 12-17

Figure 12-19. Replotting of mortar location..... 12-18

Figure 12-20. Observed chart. 12-19

Figure 12-21. Forward plotting target to modified-observed chart from the observed chart. 12-20

Figure 12-22. Deflection conversion table..... 12-22

Figure 12-23. Resection. 12-24

Figure 12-24. Intersection. 12-25

Figure 12-25. Direction and distance. 12-26

Figure 12-26. Estimate of range from the reference point of the forward observer's location..... 12-27

Figure 13-1. Example of DA Form 2399-R (Computer's Record) with a completed call for fire and fire direction center order.	13-2
Figure 13-2. Example of DA Form 2399-R (Computer's Record) with completed adjustment.	13-3
Figure 13-3. Plotting of starting points.	13-4
Figure 13-4. Alignment of No. 2 and No. 3 plots.	13-5
Figure 13-5. Example of a completed DA Form 2399-R (Computer's Record) for a completed mission.	13-7
Figure 13-6. Example of completed DA Form 2399-R (Computer's Record) for a search mission.	13-11
Figure 13-7. Fall of rounds during a search mission.	13-12
Figure 13-8. Height of burst line for an M301A3.	13-13
Figure 13-9. FT 81-A1-3, charge 8, used in determination of location of round in relation to the height of burst.	13-14
Figure 13-10. Firing adjustment.	13-16
Figure 13-11. Firing adjustment.	13-17
Figure 13-12. FT 81-A1-3, charge 5, used in determination of location of round in relation to the height of burst.	13-18
Figure 13-13. Firing adjustment.	13-20
Figure 14-1. Splitting of a 50-meter bracket.	14-2
Figure 14-2. Deflection conversion table.	14-3
Figure 14-3. No. 1, No. 3, and No. 4 mortars out of sheaf.	14-4
Figure 14-4. Transfer limits for one registration point.	14-5
Figure 14-5. Multiple transfer limits.	14-6
Figure 14-6. Plotting of rounds.	14-6
Figure 14-7. Example of completed DA Form 2399-R (Computer's Record) for firing a total range correction mission on the surveyed chart.	14-9
Figure 14-8. Example of completed DA Form 2399-R (Computer's Record) for a reregistration.	14-11
Figure 14-9. Example of completed DA Form 2188-R (Data Sheet).	14-12
Figure 14-10. Example of completed DA Form 5472-R (Computer's Record [MPI]).	14-16
Figure 14-11. Altitude correction.	14-18
Figure 14-12. Determination of a spotting.	14-20
Figure 14-13. Application of correction to fire the second round.	14-20
Figure 14-14. Determination of danger mortar.	14-22
Figure 14-15. Example of completed DA Form 2399-R (Computer's Record) for computing final protective fire missions.	14-23
Figure 14-16. Drawing final protective fire symbol with attitude indexed.	14-24
Figure 14-17. Determination of danger mortar.	14-25
Figure 14-18. Plotting of No. 1, No. 2, and No. 3 mortars.	14-26
Figure 14-19. Alignment of each mortar with its impact point.	14-26
Figure 15-1. Mortar Fire Control System.	15-2
Figure 15-2. Commander's interface.	15-4
Figure 15-3. Power distribution assembly.	15-5

Figure 15-4. Pointing device..... 15-6

Figure 15-5. Gunner's display. 15-6

Figure 15-6. Driver's display..... 15-7

Figure 15-7. Vehicle motion sensor..... 15-8

Figure 15-8. Graphic user interface..... 15-10

Figure 15-9. Log-in screen. 15-12

Figure 15-10. Unit List screen. 15-14

Figure 15-11. Unit Configuration screen. 15-15

Figure 15-12. Data screen..... 15-16

Figure 15-13. Geographic Reference screen..... 15-17

Figure 15-14. Position screen. 15-18

Figure 15-15. Universal Transverse Mercator Alternate Methods screen. 15-20

Figure 15-16. Polar Alternate Methods screen. 15-21

Figure 15-17. Military Grid Reference System Alternate Methods screen..... 15-21

Figure 15-18. Latitude/ Longitude Alternate Methods screen. 15-22

Figure 15-19. Mounting Azimuth and References screen..... 15-23

Figure 15-20. Channel A screen. 15-24

Figure 15-21. Ammo By Unit screen. 15-27

Figure 15-22. Ammo Fire Unit screen. 15-28

Figure 15-23. Ammo Roll Up screen. 15-29

Figure 15-24. Status Fire Unit screen. 15-30

Figure 15-25. New Meteorological Data screen using VMF R5..... 15-34

Figure 15-26. New Meteorological Data screen using VMF PKG 11..... 15-34

Figure 15-27. Current screen. 15-35

Figure 15-28. Targets screen. 15-37

Figure 15-29. Known Points screen. 15-38

Figure 15-30. Safety Fans screen. 15-40

Figure 15-31. Check Fire screen..... 15-41

Figure 15-32. Plain Text Message Read screen..... 15-42

Figure 15-33. Send screen..... 15-43

Figure 15-34. Alerts screen. 15-44

Figure 16-1. Mission Data screen. 16-2

Figure 16-2. New Call for Fire screen. 16-5

Figure 16-3. Mission Data screen. 16-6

Figure 16-4. Solution screen. 16-7

Figure 16-5. Safety Data screen. 16-8

Figure 16-6. Plot screen. 16-9

Figure 16-7. Solution screen. 16-10

Figure 16-8. Mission Status screen..... 16-11

Figure 16-9. Messages screen..... 16-12

Figure 16-10. Mission Data screen. 16-13

Figure 16-11. End of Mission message	16-14
Figure 16-12. Save Data screen.....	16-15
Figure 16-13. Manual Call for Fire screen.....	16-16
Figure 16-14. Manual Adjust Fire screen.....	16-18
Figure 16-15. Manual End of Mission screen.....	16-19
Figure 16-16. Save Registration screen.....	16-20
Figure 16-17. Registration screen.....	16-21
Figure 16-18. Targets screen.....	16-22
Figure 16-19. Known Points screen.....	16-23
Figure 16-20. New Call for Fire screen.....	16-24
Figure 16-21. Mission Data screen.....	16-25
Figure 16-22. Solution screen.....	16-26
Figure 16-23. Safety Data screen.....	16-27
Figure 16-24. Solution screen.....	16-28
Figure 16-25. Mission Status screen.....	16-29
Figure 16-26. Messages screen.....	16-30
Figure 16-27. New Call for Fire screen.....	16-33
Figure 16-28. Final Protective Fire Mission Data screen.....	16-34
Figure 16-29. Final Protective Fire Solution screen.....	16-35
Figure 16-30. Safety Data screen.....	16-36
Figure 16-31. Solution screen.....	16-37
Figure 16-32. Plot screen.....	16-38
Figure 16-33. Mission Status screen.....	16-39
Figure 16-34. Subsequent Adjust screen.....	16-40
Figure 16-35. Solution End of Mission screen.....	16-41
Figure 16-36. Mission Status screen.....	16-42
Figure 16-37. Messages screen.....	16-43
Figure 17-1. Lightweight handheld mortar ballistic computer.....	17-2
Figure 17-2. Lightweight handheld mortar ballistic computer interface.....	17-3
Figure 17-3. Lightweight handheld mortar ballistic computer graphic user interface.....	17-4
Figure 17-4. Desktop.....	17-5
Figure 17-5. Password screen.....	17-9
Figure 17-6. Setup Geographical Reference screen.....	17-10
Figure 17-7. Minimum easting and northing.....	17-11
Figure 17-8 Locating minimum zone.....	17-11
Figure 17-9 Unit List screen.....	17-12
Figure 17-10 Unit List Add/Edit screen.....	17-13
Figure 17-11. Ammunition screen.....	17-15
Figure 17-12. Ammunition Add/Edit screen.....	17-15
Figure 17-13. Ammunition Roll-Up screen.....	17-16
Figure 17-14. Setup Data screen.....	17-17

Figure 17-15. Met New screen..... 17-18

Figure 17-16. Met Edit Station screen..... 17-19

Figure 17-17. Met New Edit Lines Screen. 17-19

Figure 17-18. Met Current screen. 17-20

Figure 17-19. Safety Fan Segment screen. 17-21

Figure 17-20. Add New Safety Fan Segment screen..... 17-21

Figure 17-21. Lightweight handheld mortar ballistics computer communications connector. 17-23

Figure 17-22. Setup Commo Parameters screen. 17-24

Figure 17-23. Setup Commo Addresses screen. 17-26

Figure 17-24. Edit Commo Address screen. 17-27

Figure 17-25. Send Status screen..... 17-28

Figure 17-26. Global Positioning System Status screen..... 17-30

Figure 18-1. Manual Missions menu. 18-2

Figure 18-2. Manual grid mission entry. 18-2

Figure 18-3. Mission Data screen. 18-3

Figure 18-4. Solution/Gun Orders screen. 18-5

Figure 18-5. <Target> screen..... 18-6

Figure 18-6. Safety Data screen. 18-8

Figure 18-7. Subsequent Adjust screen. 18-9

Figure 18-8. End of Mission screen..... 18-10

Figure 18-9. Ammunition Expended screen. 18-11

Figure 18-10. Shift Mission screen. 18-12

Figure 18-11. Polar Mission screen..... 18-13

Figure 18-12. Laser Polar Mission screen. 18-14

Figure 18-13. Quick Fire Mission screen. 18-15

Figure 18-14. Direct Lay Mission screen..... 18-16

Figure 18-15. Direct Lay: first adjustment. 18-17

Figure 18-16. Hipshoot Mission screen..... 18-17

Figure 18-17. Hipshoot Solution screen. 18-18

Figure 18-18. Hipshoot: Subsequent Adjustment screen. 18-19

Figure 18-19. Hipshoot End of Mission screen. 18-20

Figure 18-20. Targets screen. 18-21

Figure 18-21. Mission priority icon displayed on the Menu button..... 18-22

Figure 18-22. Call for fire menu selection. 18-22

Figure 18-23. Digital Fire Mission: New Call For Fire screen. 18-23

Figure 18-24. Digital Fire Mission: Mission Data screen..... 18-24

Figure 18-25. Digital Fire Mission: Solution/Gun Orders screen..... 18-25

Figure 18-26. Digital Fire Mission: Message Send Status screens. 18-25

Figure 18-27. Digital Fire Mission: <Target> screen. 18-27

Figure 18-28. Digital Fire Mission: Mission Status screen. 18-27

Figure 18-29. Digital Fire Mission: Mission Messages screens..... 18-29

Figure 18-30. Digital Fire Mission: first adjustment. 18-29

Figure 18-31. Digital Fire Mission: final adjustment..... 18-30

Figure 18-32. Digital Fire Mission: Fire for Effect Solution screen. 18-30

Figure 18-33. Digital Fire Mission: selecting Rnds Complete..... 18-31

Figure 18-34. Digital Fire Mission: end of mission message..... 18-32

Figure 18-35. Digital Fire Mission: Select Known Point Number screen..... 18-32

Figure 18-36. Registration: Mission Initialization screen. 18-34

Figure 18-37. Registration: Solution/Gun Orders screen. 18-35

Figure 18-38. Registration: first subsequent adjustment. 18-36

Figure 18-39. Registration: second subsequent adjustment. 18-36

Figure 18-40. Registration: Fire For Effect Solution screen. 18-36

Figure 18-41. Registration: Adjust Sheaf screen..... 18-37

Figure 18-42. Registration: Error and Warnings screen..... 18-38

Figure 18-43. Registration: Save Registration Point screen..... 18-39

Figure 18-44. Illumination: Mission Initialization screen. 18-40

Figure 18-45. Illumination: Targets screen. 18-41

Figure 18-46. Illumination: solution and display of fuze setting. 18-43

Figure 18-47. Illumination: Safety Data screen..... 18-44

Figure 18-48. Illumination: first subsequent adjustment. 18-45

Figure 18-49. Illumination: second subsequent adjustment. 18-45

Figure 18-50. One-gun Illumination Fire For Effect Solution screen. 18-46

Figure 18-51. Coordinated Illumination: Mission Initialization screen. 18-47

Figure 18-52. Coordinated Illumination: Mission Data screen..... 18-48

Figure 18-53. Coordinated Illumination: High-Explosive Solution screen. 18-48

Figure 18-54. Manual Grid Final Protective Fire: Mission Initialization screen..... 18-50

Figure 18-55. Final Protective Fire: Mission Data screen..... 18-50

Figure 18-56. Final Protective Fire: Initial Solution screen. 18-51

Figure 18-57. Final Protective Fire: changing the adjusting gun. 18-52

Figure 18-58. Final Protective Fire: first adjustment..... 18-53

Figure 18-59. Final Protective Fire: A1's initial adjustment. 18-53

Figure 18-60. Final Protective Fire: A1's second adjustment and solution. 18-54

Figure 18-61. Final Protective Fire: preparing to adjust the sheaf. 18-55

Figure 18-62. Final Protective Fire: adjusting A2..... 18-56

Figure 18-63. Final Protective Fire: A3's solution..... 18-57

Figure 18-64. Final Protective Fire: A4's adjustment solution. 18-58

Figure 18-65. Final Protective Fire: section solution. 18-59

Figure 18-66. Final Protective Fire: changing the fire for effect volleys. 18-59

Figure 18-67. Final Protective Fire: storing the final protective fires. 18-60

Figure 18-68. Quick Smoke: target location information. 18-62

Figure 18-69. Quick Smoke: Mission Initialization screen..... 18-62

Figure 18-70. High-Explosive Adjustment Phase – first solution..... 18-63

Figure 18-71. High-Explosive Adjustment Phase: first adjustment. 18-64

Figure 18-72. High-Explosive Adjustment Phase: first adjustment solution. 18-64

Figure 18-73. High-Explosive Adjustment Phase: second adjustment. 18-64

Figure 18-74. High-Explosive Adjustment Phase: second adjustment solution..... 18-64

Figure 18-75. High-Explosive Adjustment Phase: change the method of fire from
adjust to fire for effect. 18-65

Figure 18-76. High-Explosive Adjustment Phase: first confirmation round..... 18-65

Figure 18-77. Smoke Card screen. 18-66

Figure 18-78. Smoke Card example with solution. 18-67

Figure 18-79. Quick Smoke: guns A1, A2, A3, and A4 solutions for the maintaining
phase. 18-68

Figure 18-80. Quick Smoke: End of Mission screen. 18-69

Figure 18-81. Quick Smoke: Ammunition Expended screen. 18-69

Figure 18-82. Immediate Smoke: Mission Initialization screen..... 18-70

Figure 18-83. Immediate Smoke: Mission Data screen. 18-71

Figure 18-84. Immediate Smoke: Solution/Gun Orders screen. 18-71

Figure 18-85. Immediate Suppression: Mission Initialization screen..... 18-72

Figure 18-86. Immediate Suppression: Mission Data screen. 18-73

Figure 18-87. Immediate Suppression: Solution/Gun Orders screen. 18-73

Figure 18-88. Search and Traverse: Mission Initialization screen. 18-74

Figure 18-89. Search and Traverse: Mission Data screen. 18-75

Figure 18-90. Search and Traverse Sheaf Information screen..... 18-75

Figure 18-91. Search and Traverse Operation screen. 18-76

Figure 18-92. Search and Traverse: initial solution..... 18-79

Figure 18-93. Search and Traverse: first adjustment..... 18-79

Figure 18-94. Search and Traverse: second solution. 18-80

Figure 18-95. Search and Traverse: final adjustment..... 18-80

Figure 18-96. Search and Traverse: fire for effect solution..... 18-81

Figure 18-97. Search and Traverse Round and Hand Wheel Fire Data screen..... 18-82

Figure 18-98. Search and Traverse: End of Mission and Ammunition Expended
screens..... 18-83

Figure C-1. Mortar surface danger zone. C-2

Figure C-2. Effects of vertical interval and crest clearances..... C-3

Figure C-3. Basic safety diagram. C-5

Figure C-4. Safety T. C-6

Figure D-1. Three distant points..... D-1

Figure D-2. Line drawn in any direction. D-2

Figure D-3. Protractor aligned with correct azimuth..... D-2

Figure D-4. Two more lines drawn from dot..... D-3

Figure D-5. Positioning of tracing paper..... D-3

Figure D-6. Hasty survey..... D-4

Figure D-7. Subtense bar. D-5

Figure D-8. Traverse leg 1..... D-6

Figure D-9. Construction of a diagram..... D-7

Figure D-10. Distance table for a 2-meter subtense bar. D-8

Figure E-1. Situation A (excerpt from an example of completed DA Form 2399-R [Computer's Record]). E-7

Figure E-2. Call for fire and FDC order (excerpt from an example of completed DA Form 2399-R [Computer's Record]). E-9

Figure E-3. Situation C (excerpt from an example of completed DA Form 2399-R [Computer's Record]). E-11

Figure E-4. Situation D: first mission (an example of completed DA Form 3677-R [Computer MET Message]). E-14

Figure E-5. Situation D: second mission (excerpt from an example of completed DA Form 2399-R [Computer's Record]). E-15

Figure E-6. Situation E (excerpt from an example of completed DA Form 2399-R [Computer's Record]). E-19

Figure E-7. Situation F (excerpt from an example of completed DA Form 2399-R [Computer's Record]). E-22

Figure E-8. Situation G: first mission (excerpt from an example of completed DA Form 2399-R [Computer's Record]). E-24

Figure E-9. Situation G: second mission (excerpt from an example of completed DA Form 2399-R [Computer's Record]). E-25

Figure E-10. Situation H (excerpt from an example of completed DA Form 2399-R [Computer's Record]). E-29

Figure E-11. Situation I (excerpt from an example of completed DA Form 2399-R [Computer's Record]). E-31

Figure E-12. Situation J (excerpt from an example of completed DA Form 2399-R [Computer's Record]). E-33

Figure E-13. Situation K (excerpt from an example of completed DA Form 2399-R [Computer's Record]). E-35

Figure E-14. Situation L (excerpt from an example of completed DA Form 2399-R [Computer's Record]). E-38

Figure E-15. Situation M (excerpt from an example of completed DA Form 2399-R [Computer's Record]). E-39

Figure E-16. Situation N (excerpt from an example of completed DA Form 2399-R [Computer's Record]). E-41

Figure E-17. Situation N: second mission (excerpt from an example of completed DA Form 2399-R [Computer's Record]). E-42

Figure E-18. Situation B: first mission (excerpt from an example of completed DA Form 2399-R [Computer's Record]). E-48

Figure E-19. Situation B: second mission (excerpt from an example of completed DA Form 2399-R [Computer's Record]). E-49

Figure E-20. Situation B: third mission (excerpt from an example of completed DA Form 2399-R [Computer's Record]). E-51

Figure E-21. Situation B: fourth mission (excerpt from an example of completed DA Form 2399-R [Computer's Record]). E-52

Figure E-22. Situation C: first mission (excerpt from an example of completed DA Form 2399-R [Computer's Record]). E-55

Figure E-23. Situation C: second mission (excerpt from an example of completed DA Form 2399-R [Computer's Record]). E-58

Tables

Table 1-1. Battalion fire support personnel. 1-3

Table 1-2. Company fire support personnel. 1-3

Table 2-1. Consolidated target list..... 2-21

Table 2-2. Rates of fire for the 60-mm mortar. 2-24

Table 2-3. Rates of fire for the 81-mm mortar. 2-24

Table 2-4. Rates of fire for the 120-mm mortar. 2-25

Table 2-5. Targets and methods of attack. 2-28

Table 2-5. Targets and methods of attack (continued). 2-29

Table 4-1. Types of sheaves. 4-2

Table 4-2. FDC order field titles and information documented in each field. 4-5

Table 4-3. Initial chart data field titles and information documented in each field. 4-6

Table 4-4. Initial fire command field titles and information documented in each field..... 4-6

Table 4-5. Observer correction field titles and information documented in each field. 4-7

Table 4-6. Chart data field titles and information documented in each field. 4-7

Table 4-7. Subsequent command field titles and information documented in each field..... 4-8

Table 4-8. Setup field titles and information documented in each field..... 4-10

Table 4-9. Weapon data field titles and information documented in each field. 4-10

Table 4-10. Forward observer data field titles and information documented in each field. 4-11

Table 4-11. Ammunition data field titles and information documented in each field..... 4-11

Table 4-12. Target identification field titles and information documented in each field. 4-11

Table 4-13. Chart data field titles and information documented in each field. 4-12

Table 4-14. Firing correction field titles and information documented in each field. 4-12

Table 4-15. Firing data field titles and information documented in each field. 4-12

Table 4-16. Intelligence field titles and information documented in each field..... 4-13

Table 4-17. Geographical Reference field titles and information documented in each field. 4-15

Table 4-18. Data field titles and information documented in each field. 4-15

Table 4-19. Weapon Data field titles and information documented in each field..... 4-15

Table 4-20. Subscribers field titles and information documented in each field..... 4-16

Table 4-21. Commo field titles and information documented in each field. 4-16

Table 4-22. Character groups in the introduction and their corresponding meanings..... 4-26

Table 4-23. Character groups in the body and their corresponding meanings..... 4-27

Table 4-24. DA Form 2601-1-R (MET Data Correction Sheet for Mortars) field titles and information documented in each field. 4-29

Table 6-1. Mortars and corresponding ammunition. 6-12

Table 8-1. TFC menu abbreviations and their uses. 8-12

Table 8-2. Gun-target azimuth chart. 8-16

Table 9-1. Normal final protective fire dimensions, for each number of mortars.....	9-8
Table 9-2. Smoke chart for the 120-mm M929 WP.	9-15
Table 9-3. Smoke chart for the 81-mm M819 red phosphorus.....	9-16
Table 9-4. Message switch entries and related information.	9-20
Table 9-5. Transmit switch entries and related information.....	9-21
Table 9-6. Safety Data switch entries and related information.	9-21
Table 12-1. Replotting of previously fired targets.	12-21
Table 13-1. M16 plotting board data for traversing fire.....	13-1
Table 13-2. Example of illumination adjustment.	13-13
Table 14-1. Plotting of a surveyed registration.	14-2
Table 15-1. Function keys.....	15-3
Table 16-1. Tabs and screens.	16-3
Table 17-1. Battery life expectancy.....	17-4
Table 17-2. Message icons.....	17-7
Table 17-3. Message priorities.....	17-7
Table 17-4. Parameter Setup fields and settings.....	17-25
Table 17-5. Global Positioning System crypto key status and meaning.	17-31
Table 18-1. Grid Mission screen fields and related information.	18-3
Table 18-2. Mission Data screen fields and related information.	18-4
Table 18-3. Solution/Gun Orders screen fields and buttons, and related information.	18-5
Table 18-4. <Target> screen buttons and related information.	18-7
Table 18-5. Safety Data screen fields and related information.....	18-8
Table 18-6. Subsequent Adjust screen fields and related information.	18-10
Table 18-7. End of Mission screen selections and related information.	18-11
Table 18-8. Digital Fire Mission: New Call For Fire screen control buttons and related information.....	18-23
Table 18-9. Digital Fire Mission: Message box fields and purposes.	18-23
Table 18-10. Digital Fire Mission: Send Status screen Message window fields and purposes.....	18-26
Table 18-11. Digital Fire Mission: Mission Status screen fields and buttons, and purposes.....	18-28
Table 18-12. Illumination: additional sheaves and related information.	18-42
Table 18-13. Illumination: two-gun range and lateral spread distances.	18-42
Table 18-14. Quick Smoke: Mission Data screen fields and related information.....	18-63
Table 18-15. Search and Traverse Sheaf Information screen fields and related information.....	18-76
Table 18-16. Search and Traverse Sheaf Operation screen fields and related information.	18-77
Table 18-17. Search and Traverse types and methods.	18-78
Table 18-18. Search and Traverse Round and Hand Wheel Fire Data screen fields and related information.....	18-82

Preface

This manual provides guidance for military occupational specialty (MOS) 11C Soldiers and their trainers on the employment of the 60-mm mortars (M224), 81-mm mortar (M252), and 120-mm mortar (M120). It discusses the practical applications of ballistics and a system combining the principles, techniques, and procedures essential to the delivery of timely and accurate mortar fire. (See FM 3-22.90 for information about mechanical training, crew drills, and the characteristics, components, and technical data of each mortar.)

This manual is divided into six parts. Part 1 discusses the fundamentals of mortar fire direction; Part 2 summarizes the operational procedures of a fire direction center (FDC); Part 3 describes the capabilities and use of the mortar ballistic computer (MBC); Part 4 describes the capabilities and use of the M16/M19 plotting boards; Part 5 discusses the Mortar Fire Control System (MFCS); and Part 6 discusses the lightweight handheld mortar ballistic computer (LHMBC).

This manual was revised to delete references to obsolete material and systems and add references to new material and systems. In addition to various editorial corrections, this revision—

- Removes all references to M2 and M19 mortar systems, as they are now obsolete.
- Removes all references to M29 and M29A1 mortar systems, as they are now obsolete, except for M29A1 use with the M303 subcaliber insert.
- Adds references to the LHMBC.
- Replaces references to common terms with their accepted modifications.

This publication prescribes DA Form 2188-R (Data Sheet), DA Form 2188-1-R (LHMBC/MFCS Data Sheet), DA Form 2399-R (Computer's Record), DA Form 5472-R (Computer's Record [MPI]), DA Form 2601-2-R (MET Data Correction Sheet 6400 Mils [Mortars]), and DA Form 2601-1-R (MET Data Correction Sheet for Mortars).

This publication applies to the Active Army, the Army National Guard (ARNG)/Army National Guard of the United States (ARNGUS), and the US Army Reserve (USAR) unless otherwise stated.

Terms that have joint or Army definitions are identified in both the glossary and the text. Terms for which FM 3-22.91 is the proponent FM are indicated with an asterisk in the glossary.

Uniforms depicted in this manual were drawn without camouflage for clarity of the illustration. Unless this publication states otherwise, masculine nouns and pronouns refer to both men and women.

The proponent for this publication is the US Army Training and Doctrine Command. The preparing agency is the US Army Infantry School. You may send comments and recommendations by any means (US mail, e-mail, fax, or telephone) as long as you use DA Form 2028 (Recommended Changes to Publications and Blank Forms) or follow its format. Point of contact information is as follows:

E-mail: benn.29IN.229-S3-DOC-LIT@conus.army.mil
Phone: Commercial: 706-545-8623
DSN: 835-8623
Fax: Commercial: 706-545-8600
DSN: 835-8600
US Mail: Commandant, USAIS
ATTN; ATSH-INB
6650 Wilkin Drive, Bldg 74, Rm 102

This page intentionally left blank.

PART ONE

Introduction and Fundamentals of Mortar Fire Direction

Chapter 1

Introduction

The mission of the mortar platoon is to provide close and immediate indirect fire support for maneuver battalions and companies.

ORGANIZATION

1-1. Mortars are organized as part of a company, battalion, and cavalry squadron. They are organized either as sections or platoons in infantry brigade combat team (IBCT) companies and as platoons in tank and heavy brigade combat team (HBCT) battalions. Regardless of the organization to which they belong, mortars have the battlefield role of providing the maneuver commander with immediate indirect fires. Mortars fulfill this mission when all of the elements responsible for placing effective mortar fire on the enemy are properly trained.

GENERAL DOCTRINE

1-2. Doctrine demands the timely and accurate delivery of indirect fire to meet the needs of supported units. All members of the indirect fire team must strive to reduce, by all possible measures, the time required to execute an effective fire mission; they must be thoroughly indoctrinated with a sense of urgency. A key principle of effective training is the use of appropriate doctrine. (See Appendix A for more information.)

1-3. Good observation is required for effective mortar fire. Limited observation results in a great expenditure of ammunition and less effective fire. Every target needs some type of observation to ensure that fire is placed on the target. Observation of close battle areas is usually visual. Radar or sound observation is best used when terrain features hide targets or when great distance or limited visibility is involved. When observation is possible, corrections can be made to place mortar fire on the target using adjustment procedures. Lack of observation, however, must not preclude firing on targets that can be located by other means.

1-4. Mortar fire must be delivered using the most accurate means that time and the tactical situation permit. When possible, survey data will be used to accurately locate the mortar position and target. Under some conditions, only a rapid estimate of the relative location of weapons and targets may be possible.

1-5. To achieve effective massed fires, units should survey the area using accurate maps of mortar positions, registration points (RPs), and targets. The immediate objective is to deliver a large volume of accurate, timely fire to cause as many enemy casualties as possible. Surprise fire often increases the number of casualties inflicted in a target area. If surprise massed fires cannot be achieved, the time required to bring effective fires on the target should be as brief as possible.

1-6. Mortars can inflict the greatest demoralizing effect on the enemy by delivering as many rounds as possible (from all mortars in a section or platoon) in the shortest period of time possible.

1-7. Mortar units must be prepared to handle multiple fire missions. Mortars are area fire weapons, but units can employ them to neutralize or destroy area or point targets, to screen large areas with smoke for sustained periods, to provide illumination, or to provide an immediate, heavy volume of accurate fire for sustained periods.

1-8. In HBCT battalions, units can normally fire mortars from mortar carriers (mortars maintain their ground-mounted capability). This permits rapid displacement and quick reaction to the tactical situation.

INDIRECT FIRE TEAM

1-9. The team mission is to provide accurate, timely response to the unit it supports. Effective communication is vital to the successful coordination of the indirect fire team's efforts. Indirect fire procedures are a team effort (Figure 1-1). They include locating the target, designating the correct asset to fire the mission, determining firing data, clearing indirect surface-to-surface fires, applying data to the mortar, and preparing the ammunition. Since the mortar is normally fired from the defilade position (where the crew cannot see the target), the indirect fire team gathers and applies the required data, and coordinates and synchronizes the fires with the concept of the operation. This team consists of a fire support officer (FSO) in the fires cell (FC), forward observer (FO), a fire direction center (FDC), and mortar squads.

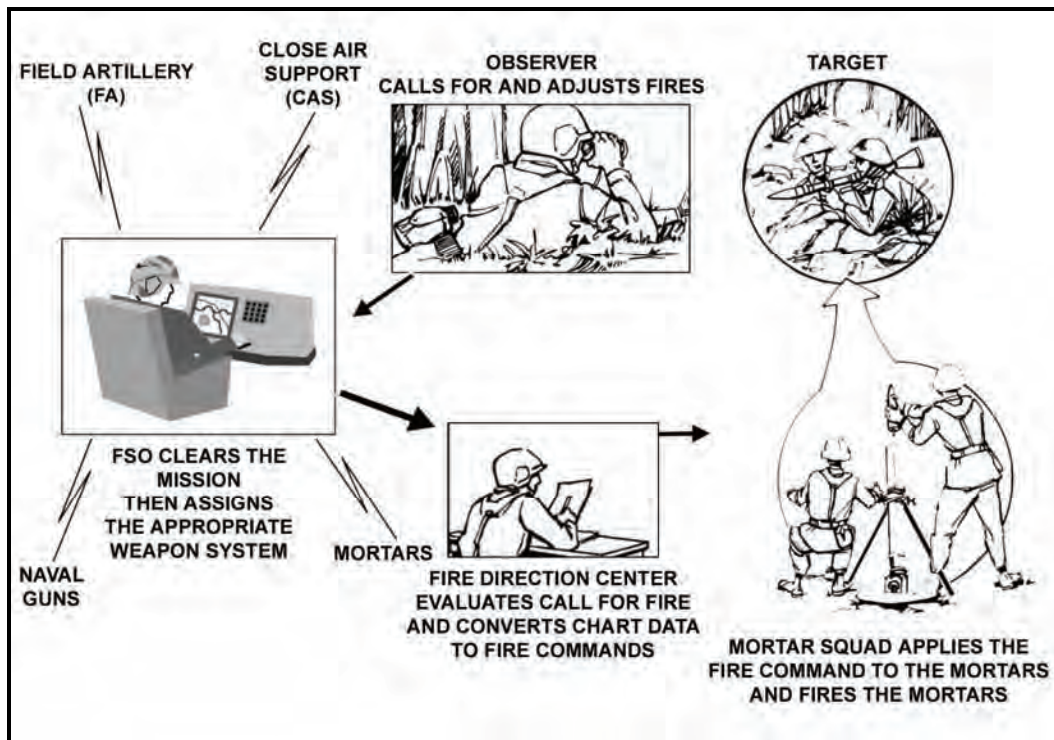

Figure 1-1. Indirect fire team.

1-10. The battalion FSO coordinates and synchronizes fire support for the maneuver battalion. He is in charge of the FC and is the principal fire support advisor to the maneuver battalion commander. The FC is located with the operations element of the maneuver force. The commander is responsible for integrating fire support, but typically delegates planning and supervisory authority for clearing indirect fires for the unit to the FSO. Table 1-1 shows the organization of an FC in support of IBCT and HBCT battalions.

Table 1-1. Battalion fire support personnel.

BATTALION FIRE SUPPORT PERSONNEL		
	IBCT	HBCT
FSO	1	1
Fire Support Plans/ Targeting Officer	0	1
Fire Support Sergeant	1	1
Fire Support Specialist	2	2
Radio/Telephone Operators	0	2

1-11. The battalion HHC fire support platoon provides FISTs to the battalion's maneuver companies upon deployment. FISTs typically move to and remain with their supported companies and platoons. Table 1-2 shows the organization of a fire support team (FIST) in support of IBCT and HBCT companies.

Table 1-2. Company fire support personnel.

COMPANY FIRE SUPPORT PERSONNEL		
	IBCT	HBCT
Company FSO	1	1
Fire Support Sergeant	1	1
Fire Support Specialist	1	1
Radio Operator	1	1
Platoon FO	3	0
Platoon FO Radio Operator	3	0

1-12. The FDC has two computer personnel in each section (except the 60-mm squad, which does not have assigned FDC personnel) who control the firing of mortars. They convert data received from the FO in a call for fire (CFF) into firing data that can be applied to the mortar and ammunition.

1-13. Mortar squads organic to HBCT, and IBCT battalions consist of one squad leader, one gunner, one assistant gunner, and one ammunition bearer/driver. At company level, IBCT units have one six-man section consisting of one section sergeant, one squad leader, two gunners, and two assistant gunners. The squad lays the mortar and prepares the ammunition using data from the FDC fire command. When the data are applied, the squad fires the mortar. The squad must also be able to fire without an FDC.

MORTAR POSITIONS

1-14. To protect mortars from enemy direct fire and observation, units should employ mortars in defilade positions when possible. These positions can also take the greatest advantage of the indirect fire role of mortars.

1-15. The use of defilade precludes sighting weapons directly at the target (direct lay); this is necessary for survival.

1-16. Mortars are indirect fire weapons. Special procedures ensure that the weapon and ammunition settings used cause the projectile to burst on the target or at the proper height above it. A coordinated effort by the indirect fire team also ensures the timely and accurate engagement of targets.

1-17. To apply the essential information and engage the target from a defilade position—

- (1) Locate targets and mortar positions.
- (2) Determine chart data (direction, range, and vertical interval [VI] from mortars to targets).
- (3) Convert chart data into firing data.
- (4) Apply firing data to the mortar and to the ammunition.
- (5) Apply FO corrections and fire for subsequent rounds until a fire for effect (FFE) is achieved.

MISSIONS AND FIRE DIRECTION CONTROL PROCEDURES

1-18. Basic FDC procedures are the foundation of all mortar missions. Basic mortar missions consist only of basic FDC procedures, but special mortar missions include special FDC procedures, such as control measures.

BASIC FIRE DIRECTION CENTER PROCEDURES

1-19. Basic FDC procedures include—

- Grid.
- Shift from a known point.
- Polar plot.
- Special sheaf adjustments.
- Registration.
- Meteorological (MET) correction.

Grid

1-20. For a grid mission, the observer expresses the target location using the target's grid coordinates.

Shift from a Known Point

1-21. For a shift from a known point mission, the observer expresses the target location using the target's direction and distance from a known point.

Polar Plot

1-22. For a polar plot mission, the observer expresses the target location using the target's direction and distance from the observer. The observer's location must be known prior to calling a polar plot mission.

Special Sheaf Adjustments

1-23. Special sheaf adjustments involve altering the placement of rounds on the ground between guns. The sheaf may be open, converged, linear (formerly known as standard), parallel, or special.

Registration

1-24. Registration involves applying fire corrections to resolve interior and exterior ballistics and errors in gun/target location. This process is similar to zeroing a rifle.

Meteorological Correction

1-25. MET correction involves correcting for variations in weather conditions.

SPECIAL FIRE DIRECTION CENTER PROCEDURES

1-26. Special FDC procedures include—

- Search.
- Traverse.
- Search and traverse.
- Illumination.
- Coordinated illumination.
- Split.
- Simo.
- Final protective fire (FPF).
- Smoke.

Search

1-27. Mortarmen use search procedures to fire upon targets that are deeper than the burst diameter of the round being fired.

NOTE: Search procedures exclude use of the Mortar Fire Control System (MFCS).

Traverse

1-28. Mortarmen use traverse procedures to fire upon targets that are wider than the sections/platoons that engage them.

NOTE: Traverse procedures exclude use of the MFCS.

Search and Traverse

1-29. Mortarmen use search and traverse procedures to fire upon targets with attitudes neither parallel nor perpendicular to the gun-target line.

NOTE: Search and traverse procedures apply to the lightweight handheld mortar ballistic computer (LHMBC) only.

Illumination

1-30. Mortarmen use illumination procedures to illuminate a portion of the battlefield.

Coordinated Illumination

1-31. Coordinated illumination procedures combine illumination with high-explosive (HE), red phosphorus, or white phosphorus (WP) to illuminate and engage a target.

Split

1-32. Split procedures involve firing upon a single target from more than one location.

Simo

1-33. Simo procedures involve simultaneous fire upon two targets from a single location.

Final Protective Fire

1-34. Final protective fire (FPF) is a final defensive measure to prevent friendly units from being overrun.

Smoke

1-35. Mortarmen may use immediate or quick smoke. Advanced planning of quick smoke is essential, since it requires large amounts of ammunition and prior coordination with all troops in the vicinity of the intended screen or curtain.

FIRE CONTROL SYSTEMS

- 1-36. The six fire control systems include—
- M16 plotting board.
 - M19 plotting board.
 - M23 mortar ballistic computer (MBC).
 - M95 MFCS.
 - M96 MFCS.
 - M32 LHMBC.

M16 PLOTTING BOARD

1-37. HBCT and IBCT BN Mortar, forces use the M16 plotting board as a backup manual fire control system.

M19 PLOTTING BOARD

1-38. IBCT Company sections use the M19 plotting board as a backup manual fire control system.

M23 MORTAR BALLISTICS COMPUTER

1-39. Since 1985, the M23 MBC has been the primary electronic fire control system for IBCT and HBCT forces, but it is currently being replaced by the M95 MFCS, M96 MFCS, or M32 LHMBC.

M95 MORTAR FIRE CONTROL SYSTEM

1-40. The M95 MFCS is installed in M1064 and M1129 Stryker mortar carriers.

M96 MORTAR FIRE CONTROL SYSTEM

1-41. The M96 MFCS is installed in the M577 in the HBCT.

M32 LIGHTWEIGHT HANDHELD MORTAR BALLISTIC COMPUTER

1-42. The M32 LHMBC is the new primary electronic fire control system for all dismounted forces.

Chapter 2

Fundamentals of Mortar Fire Direction

This chapter discusses the elements of firing data, ballistics, firing tables, fire planning, target analysis, and methods of attack (MOA). This information enables the FDC to engage the enemy, even during adverse conditions.

SECTION I. ELEMENTS OF FIRING DATA AND BALLISTICS

Mortarmen apply firing data to ammunition and mortars so that the fired projectile bursts at the desired location. These data are based on the direction, horizontal range, and vertical interval (VI) from the mortar to the target; the pattern of bursts desired at the target; and MET conditions. (See Appendix C for more information.)

DIRECTION

2-1. In mortar gunnery, direction is a horizontal angle measured from a fixed reference. The indirect fire team measures direction in mils clockwise from grid north (the direction of the north-south grid lines on a tactical map). The team emplaces its mortars on a mounting azimuth, and then uses the direction to make angular shifts onto the target. Direction to the target may be computed, determined graphically, or estimated (Figure 2-1).

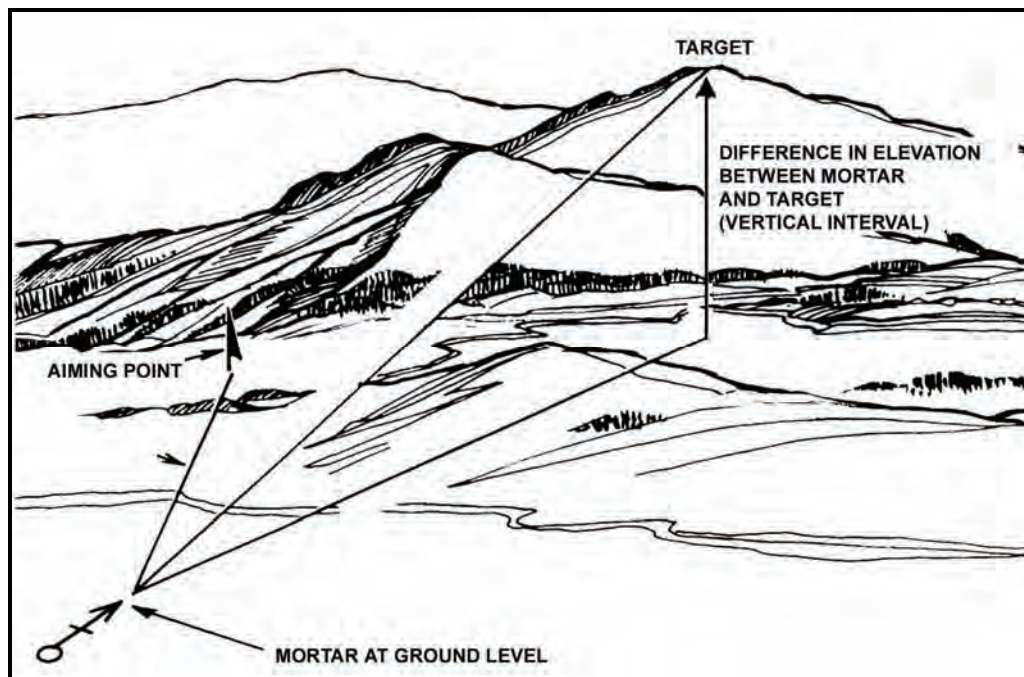

Figure 2-1. Direction to the target.

NOTE: In mortar gunnery, the unit of angular measurement is the mil. A mil equals about 0.056 of a degree. There are 17.8 mils in a degree and 6400 mils in a 360-degree circle.

RANGE

2-2. Range is the computed, measured, or estimated horizontal distance (expressed in meters) from the mortar to the target. The range of a projectile depends on its muzzle velocity and the elevation of the mortar.

VERTICAL INTERVAL

2-3. VI is the altitude difference between the mortar section and the target or point of burst. It is determined using maps, survey, or a shift from a known point.

DISTRIBUTION OF BURSTS

2-4. Distribution of bursts is the pattern of bursts in the target area. When in a standard formation, all mortars of a section or platoon generally fire with the same deflection, fuze setting, charge, and elevation. Since targets may be various shapes and sizes and mortars may use terrain positioning, mortarmen either adjust the pattern of bursts to the shape and size of the target or compute and apply individual mortar corrections for deflection, fuze setting, charge, and elevation to achieve a specific pattern of bursts.

INTERIOR BALLISTICS

2-5. Interior ballistics deals with the factors affecting the motion of a mortar round before it leaves the muzzle of the barrel. The total effect of all interior ballistic factors determines the velocity with which the projectile leaves the muzzle. This type of velocity, called muzzle velocity, is expressed in meters per second (MPS).

NATURE OF PROPELLANTS AND PROJECTILE MOVEMENTS

2-6. Propellant, a low-order explosive that burns rather than detonates, is the mortar fire's semi-fixed ammunition. When gases from the burning propellant develop enough pressure to overcome projectile weight and initial bore resistance, the projectile begins to move.

2-7. Gas pressure peaks quickly and subsides gradually after the projectile begins to move. The peak pressure, together with the travel of the projectile in the bore, determines the speed at which the projectile leaves the barrel.

2-8. Factors that affect the velocity of a mortar-ammunition combination include—

- An increase or decrease in the rate of burning propellant increases or decreases gas pressure.
- An increase in the size of the weapon's chamber, without a corresponding increase in the amount of propellant, decreases the gas pressure.
- Gas escaping around the projectile in the barrel decreases the pressure.
- An increase in bore resistance to projectile movement before peak pressure further increases the pressure.
- An increase in bore resistance has a dragging effect on the projectile and decreases velocity. Temporary variations in bore resistance are caused by carbon buildup in the barrel or imperfections in bore shape.

STANDARD MUZZLE VELOCITY

2-9. Firing tables give the standard muzzle velocity for each charge. Values are based on a standard barrel and are guides, since they cannot be reproduced in a given instance. A specific mortar-ammunition combination cannot be selected with the assurance that it will result in a standard muzzle velocity when fired. Charge velocities are established indirectly by the military characteristics of a weapon. Since mortars are high-angle-of-fire weapons, they require greater variation in charges than howitzers, which are capable of low angles-of-fire. This variation helps achieve a range overlap between charge zones and the desired range-trajectory. Other factors considered in establishing charge velocities are the maximum range specified for the weapon and the maximum elevation and charge (with the resulting maximum pressure) that the weapon can accommodate.

NONSTANDARD MUZZLE VELOCITY

2-10. In mortar gunnery, nonstandard velocity is expressed as a variation (plus or minus MPS) from an accepted standard. Round-to-round corrections for dispersion cannot be made. Each factor causing nonstandard muzzle velocity is treated as independent of related factors.

VELOCITY TRENDS

2-11. Not all rounds of a series fired from the same weapon using the same ammunition lot will develop the same muzzle velocity. Some muzzle velocities are higher than average, and some are lower. This is called velocity dispersion. Under most conditions, the first few rounds follow a somewhat regular pattern, rather than the random pattern associated with normal dispersion. This is called velocity trend. The magnitude and extent (number of rounds) of velocity trends vary with the mortar, charge, barrel condition, and firings that precede the series. Velocity trends cannot be predicted, so computer personnel should not attempt to correct for their effects.

AMMUNITION LOTS

2-12. Each lot of ammunition has its own performance level when related to the same mortar barrel. Although the round-to-round probable error (PE) within each lot is about the same, the mean velocity developed by one lot may be higher or lower than that of another lot. Variations in the projectile, such as the diameter and hardness of the rotating disk, affect muzzle velocity. Projectile variations have a much more apparent effect on exterior ballistics than on interior ballistics.

TOLERANCES IN NEW WEAPONS

2-13. New mortars of a given size and model do not always develop the same muzzle velocity. In a new barrel, the main factors are variations in the powder chamber and in the interior dimensions of the bore. If a battalion armed with new mortars fires with a common lot of ammunition, mortars with the highest and lowest muzzle velocity will have a velocity difference of 3 or 4 MPS.

WEAR OF BARREL

2-14. Heated gases, chemical action, and friction from projectiles during continued firing wear away the bore. This wear is more pronounced when higher charges are being fired. Barrel wear allows more gases to escape past the obturator band, decreasing resistance to initial projectile movement and lessening pressure buildup, thereby decreasing muzzle velocity. Wear can be reduced by careful selection of the charge and proper cleaning of the weapon and ammunition.

TEMPERATURE OF THE PROPELLANT

2-15. Combustible material burns rapidly when it is heated before ignition. When a propellant burns more rapidly, the resulting pressure on the projectile is greater, increasing muzzle velocity. Firing tables show the magnitude of that change. Appropriate corrections to firing data can be computed, but such corrections

are valid only if they reflect the true propellant temperature. The temperature of propellants in sealed packing cases remains fairly uniform, though not always standard (70 degrees Fahrenheit).

2-16. Once the propellant is unpacked, its temperature tends to approach the prevailing air temperature. The time and type of exposure to weather results in propellant temperature variations. It is not practical to measure propellant temperature and to apply corrections for each round fired by each mortar. Propellant temperatures must be kept uniform; if they are not, firing is erratic. A sudden change in propellant temperature can invalidate even the most recent corrections.

2-17. To let propellants reach air temperature uniformly—

- Ready ammunition should be kept off of the ground.
- Ammunition should be protected from dirt, moisture, and direct sunrays.
- An airspace should be created between the ammunition and protective covering.
- Unpack a sufficient number of rounds so that they are not mixed with newly unpacked ammunition. Fire rounds in the order in which they are unpacked.

MOISTURE CONTENT OF PROPELLANT

2-18. Handling and storage can cause changes in the moisture content of the propellant, which affects the velocity. Protect ammunition from moisture because moisture content cannot be measured or corrected.

BARREL TEMPERATURE

2-19. The temperature of the barrel affects the muzzle velocity. A cold barrel offers more resistance to projectile movement than a warm barrel.

PROPELLANT RESIDUES

2-20. Burned propellant and certain chemical agents mixed with expanding gases cause residue deposits on the bore surface. Properly clean and care for the barrel to prevent such deposits from causing pits in the barrel (pitting will increase abrasion by the projectiles).

OIL OR MOISTURE

2-21. Oil or moisture in the barrel or on the rotating disk increases a round's velocity by causing a better initial gas seal and reducing projectile friction on the bore surface. Too much oil or moisture in the barrel, however, decreases velocity, causing a short round.

EXTERIOR BALLISTICS

2-22. Exterior ballistics, mainly gravity and air, affect the motion of a projectile after it leaves the muzzle of the barrel. Gravity causes the projectile to fall, but air resistance impedes it. When projectiles are fired into the air, their paths differ, since projectiles of different sizes or weights respond differently to the same atmospheric conditions. A given elevation and muzzle velocity can also result in a wide variety of trajectories, depending on the combined properties of the projectile and the atmosphere.

TRAJECTORY

2-23. Trajectory is the flight path that a projectile follows from the muzzle of the mortar to its point of impact (Figure 2-2). The ascending branch is the portion of the trajectory traced while the projectile rises from its origin. The descending branch is the portion of the trajectory traced while the projectile falls. The summit, the highest point of the trajectory, is located at the end of the ascending branch and at the beginning of the descending branch. The maximum ordinate is the altitude (in meters) at the summit above the point of origin.

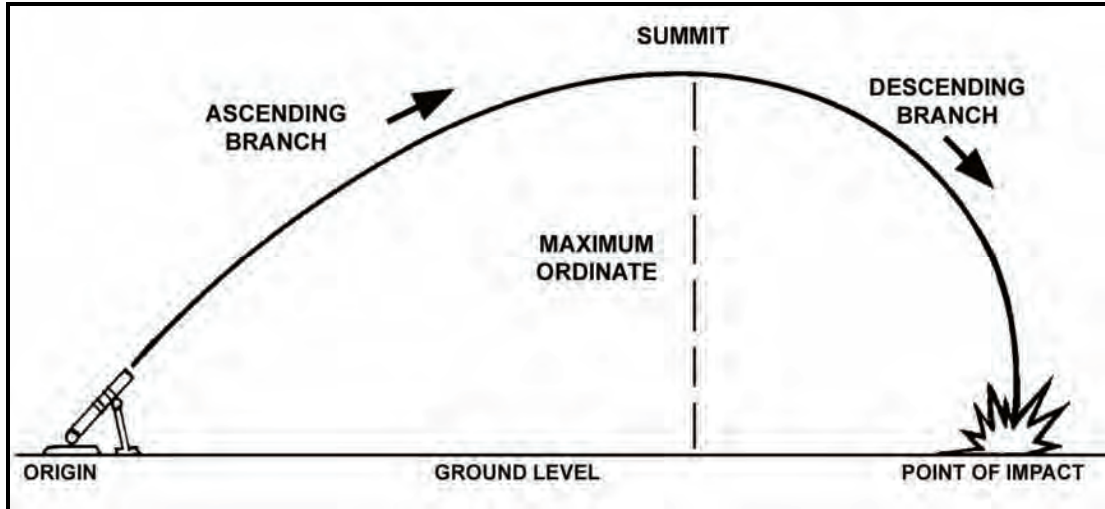

Figure 2-2. Elements of the trajectory.

TRAJECTORY IN ATMOSPHERE

2-24. Air's resistance to a projectile depends on the air's movement, density, and temperature. Standard atmosphere (an assumed density and temperature and a condition of no wind) is used to compute firing tables.

CHARACTERISTICS OF TRAJECTORY IN STANDARD ATMOSPHERE

2-25. The projectile's velocity at the level point is less than its velocity at its origin (Figure 2-2). The projectile travels more slowly beyond the summit than before it, so it does not travel as far. Its descending branch is shorter than its ascending branch, and its angle of fall is greater than its angle of elevation. In standard atmosphere, trajectory is affected by the following factors:

- Horizontal velocity decreases with continued time of flight.
- Vertical velocity is affected not only by gravity, but also by air resistance.

STANDARD CONDITIONS AND CORRECTIONS

2-26. As outlined in the introduction to the firing tables (Section II), certain atmospheric and material conditions are accepted as standard. When conditions vary from standard, the trajectory varies. Variations in the following conditions can be measured and corrected:

- Difference in altitude between the mortar and the target.
- Propellant temperature.
- Ballistic wind.
- Air temperature.
- Air density.
- Weight of the projectile.

SECTION II. FIRING TABLES

Firing tables are based on firing the weapon and its ammunition under, or correlated to, standard conditions (Figure 2-3). Those standards are used to compensate for variations in the weapon, weather, and ammunition at a given time and place. The atmospheric standards in United States' firing tables reflect the mean annual conditions in the North Temperate Zone. The main elements measured in experimental firing are angle of elevation, angle of departure, muzzle velocity, attained range, and concurrent atmospheric conditions.

4		CHARGE		TABLE D		FT 120-E-1	
M934 M734		BASIC DATA				CTG, HE FUZE, MO	
1	2	3	4	5	6	7	
R	E	D ELEV	APPROX	LINE	TIME	AZIMUTH	
A	L	PER	NO. OF	NO.	OF	CORRECTION	
N	E	100 M	URNS PER		FLIGHT		
G	V	DR	100 M DR			CW	
E						OF	
						1 KNOT	
M	MIL	MIL			SEC	MIL	
6800	912	31	7	5	44.9	0.8	
6825	904	33	7	5	44.7	0.8	
6850	895	35	8	5	44.4	0.8	
6875	887	38	8	5	44.1	0.8	

Figure 2-3. Example of Firing Table 120-E-1.

PURPOSE

2-27. The main purpose of a firing table is to provide the data required to bring effective fire on a target under any condition. Data for firing tables are obtained by firing the weapon at various elevations and charges.

UNIT CORRECTIONS

2-28. Firing tables describe unit corrections as range corrections for an increase or decrease in range, wind, air temperature, density, and projectile weight, followed by the unit value in meters.

2-29. Each correction is computed on the assumption that all other conditions are standard, but corrections differ slightly if one or more of the other conditions are nonstandard. The amount of difference depends on the effect of the other nonstandard conditions. The effect one nonstandard condition has on another is known as an interaction effect. The effect of a nonstandard condition depends on the length of time the projectile is exposed to that condition.

2-30. The weather's effect on a given projectile can be determined from a met message, if the maximum ordinate achieved is known. Personnel can compensate for those effects using the corrections listed in the appropriate firing tables.

STANDARD RANGE

2-31. The standard range is the range opposite the charge in the firing table, which is the horizontal distance from the origin to the level point. The attained range is reached by firing with a given elevation and charge. If actual firing conditions duplicate the ballistic properties and MET conditions upon which the firing table is based, the attained range and the standard range will be equal. The command range corresponds to the given elevation and charge that must be fired to reach the target.

EFFECT OF NONSTANDARD CONDITIONS

2-32. Deviations from standard conditions, if not corrected when computing firing data, causes the projectile to impact or burst somewhere other than the desired point. Nonstandard conditions that affect range also affect the time of flight.

2-33. Corrections are made for nonstandard conditions to improve accuracy. The accuracy of mortar fires depends on the accuracy and completeness of data available, computation procedures used, and care in laying the weapons. Accuracy should not be confused with precision. Precision is related to the tightness of the dispersion pattern without regard to its nearness to a desired point; accuracy is related to the location of the mean point of impact (MPI) with respect to a desired point.

RANGE EFFECTS

2-34. Factors that affect the range include—

- Vertical jump.
- Projectile's weight.
- Air resistance.
- Finish of the shell.
- Ballistic coefficient.
- Range wind.

Vertical Jump

2-35. Vertical jump is a small change in barrel elevation caused by the shock of firing, which produces a minor range dispersion. In modern weapons, vertical jump cannot be predicted and is usually small, so it is not considered separately in gunnery.

Projectile's Weight

2-36. The projectile's weight affects the muzzle velocity. Two opposing factors affect the flight of a projectile of nonstandard weight. A heavier projectile is more efficient in overcoming air resistance, but its muzzle velocity is lower because it is more difficult to push through the barrel. An increase in projectile efficiency increases range, but a decrease in muzzle velocity decreases range. In firing tables, corrections for those two opposing factors are combined into a single correction. The change in muzzle velocity predominates at shorter times of flight; the change in projectile efficiency predominates at longer times of flight. Hence, for a heavier-than-standard projectile, the correction is plus at shorter times of flight and minus at longer times of flight. The reverse is true for a lighter-than-standard projectile.

Air Resistance

2-37. Air resistance affects both range and deflection during the flight of the projectile. Air's resistance to the direction of flight is called drag. Because of drag, both the horizontal and vertical components of velocity are less at any given time of flight than they would be if drag were zero, as in a vacuum. The greater the drag, the shorter the range; and the heavier the projectile, the longer the range, all other factors being equal. Air density, air temperature, velocity, and diameter are factors considered in the computation of drag.

2-38. The drag of a given projectile is proportional to the density of the air through which it passes. For example, an increase in air density of a given percentage increases the drag by the same percentage. Since the air density at a particular place, time, and altitude varies widely, the standard trajectories reflected in firing tables are computed with a fixed relation between density and altitude. As the air temperature increases, the drag decreases, thereby increasing range.

2-39. The faster a projectile moves, the more the air resists its motion. Examination of a set of firing tables shows that, for a given elevation, the effect of 1 percent of air density (1 percent of drag) increases with an increase of charge (muzzle velocity).

2-40. Two projectiles of identical shape but different size do not experience the same drag. For example, a larger projectile offers a larger area for the air to act upon, increasing its drag.

Finish of the Shell

2-41. The finish of the shell surface affects the muzzle velocity. A rough surface on the projectile or fuze increases air resistance, thereby decreasing range.

Ballistic Coefficient

2-42. The ballistic coefficient of a projectile is its efficiency in overcoming air resistance compared to an assumed standard projectile. Each projectile and projectile lot, however, has its own efficiency level. Therefore, to establish firing tables, one specific projectile lot must be selected and fired. Based on the performance of that lot, standard ranges are determined. The ballistic coefficient of that lot becomes the firing table standard. However, other projectile lots of the same type may not have the same ballistic coefficient as the one reflected in the firing tables. If another lot is more efficient (that is, has a higher ballistic coefficient than the firing table standard), it will achieve a greater range when fired. The reverse is true for a less efficient projectile lot.

NOTE: For ease in computations, all projectile types are classified into certain standard groups.

Range Wind

2-43. Range wind is that component of the wind blowing parallel to the direction of fire (DOF) and in the plane of fire. Range wind changes the relationship between the velocity of the projectile and the velocity of the air nearby. If the air is moving with the projectile (tail wind), it offers less resistance to the projectile and a longer range results; a head wind has the opposite effect.

DEFLECTION EFFECTS

2-44. Factors that affect the deflection include—

- Crosswind.
- Lateral jump.
- Drift.
- Initial yaw.
- Summittal yaw.

CROSSWIND

2-45. The crosswind is that component of the ballistic wind blowing across the DOF. Crosswind tends to carry the projectile with it and causes a deviation from the DOF. The lateral deviation of the projectile, however, is not as large as the velocity of the crosswind acting on that projectile. Wind component tables simplify the reduction of the ballistic wind into its two components—crosswind and range wind—with respect to the DOF. (See Chapter 4 for a discussion of the wind component table.)

LATERAL JUMP

2-46. Lateral jump is a small change in barrel deflection caused by the shock of firing. The effect is ignored, since it is small and varies from round to round.

DRIFT

2-47. Drift is the departure of the projectile from standard direction due to air resistance and gravity. To understand the forces that cause drift, mortarmen must understand the angle of yaw, which is the angle between the projectile's direction of motion and axis. The yaw of a spinning projectile changes constantly: right, down, left, up.

INITIAL YAW

2-48. Initial yaw is greatest near the muzzle and gradually subsides. The atmosphere offers greater resistance to a yawing projectile, so projectiles are designed to minimize yaw and to retard it in flight.

SUMMITAL YAW

2-49. Summital yaw occurs at the summit of the trajectory and directs the nose of the projectile slightly toward the direction of spin.

DISPERSION AND PROBABILITY

2-50. The points of impact of the projectiles are scattered both laterally (deflection) and in depth (range) due to minor variations of many elements from round to round. These variations must not be confused with those caused by mistakes or constant errors. Mistakes can be removed and constant errors compensated for, but errors that cause dispersion may be due to conditions in the bore, in the bipod, or during flight. There are many conditions that affect accurate dispersion prediction, including—

- Dispersion pattern.
- Muzzle velocity.
- Direction and elevation.
- Air resistance.

DISPERSION PATTERN

2-51. If a number of rounds of the same caliber and same lot are fired from the same mortar with the same charge, elevation, and deflection, the rounds will not all fall at a single point. Instead, they will scatter in a pattern of bursts called the dispersion pattern.

CONDITIONS THAT AFFECT MUZZLE VELOCITY

2-52. Muzzle velocity is affected by conditions in the bore, such as minor variations in the weight, moisture content, temperature, and arrangement of the propelling charge. It is also affected by differences in the ignition of the charge, the weight of the projectile, and the form of the rotating disk.

CONDITIONS THAT AFFECT DIRECTION AND ELEVATION

2-53. Direction and elevation are affected by conditions of the bipod, such as play (looseness) in the traversing mechanism, physical limitations on precision in setting scales, and inconsistent reactions to firing stresses.

CONDITIONS THAT AFFECT AIR RESISTANCE

2-54. Air resistance is affected by conditions during flight, such as differences in the weight, velocity, and form of the projectile and by changes in air density, wind velocity, and temperature.

MEAN POINT OF IMPACT

2-55. For any large number of rounds fired, a line drawn perpendicular to the line of fire divides the points of impact equally. Half of the points will be beyond the line, or over; half will be inside the line, or short. For the same group of rounds, another line drawn parallel to the line of fire divides the points equally. Half of the points will be to the right of the line; half will be to the left. The first line (at right angles to the line of fire) represents the mean range; the second (parallel to the line of fire) represents the mean deflection. The lines intersect at the MPI (Figure 2-4).

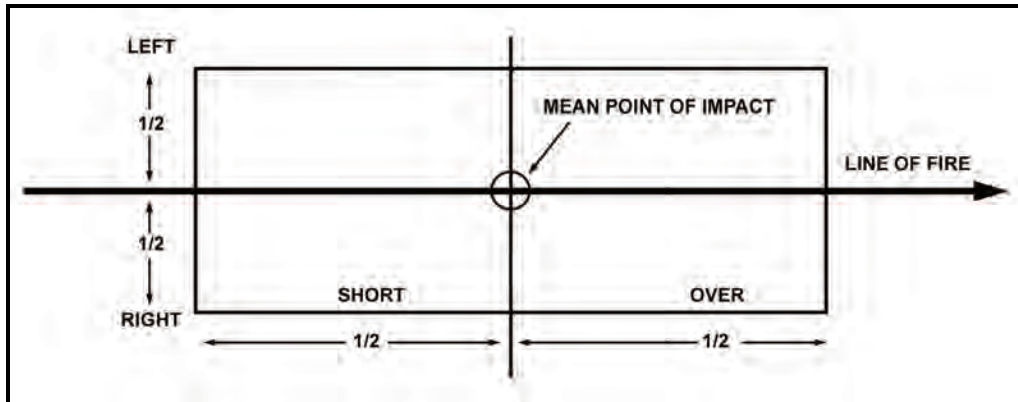

Figure 2-4. Mean point of impact.

DISPERSION SCALE

2-56. In a normal burst pattern, the number of rounds short of the MPI will be the same as the number of rounds over the MPI. The PE will be the same in both cases.

2-57. For any normal distribution (such as mortar fire), a distance of four PEs on either side of the MPI will include almost all of the rounds in the pattern. A small fraction of rounds (about 7 out of 1,000) will fall outside of four PEs on either side of the MPI.

2-58. A large number of bursts creates a roughly elliptical pattern (Figure 2-5). Since four PEs on either side of the MPI (in range and deflection) will encompass almost all rounds, a rectangle is drawn to include the full distribution of the rounds (Figure 2-6).

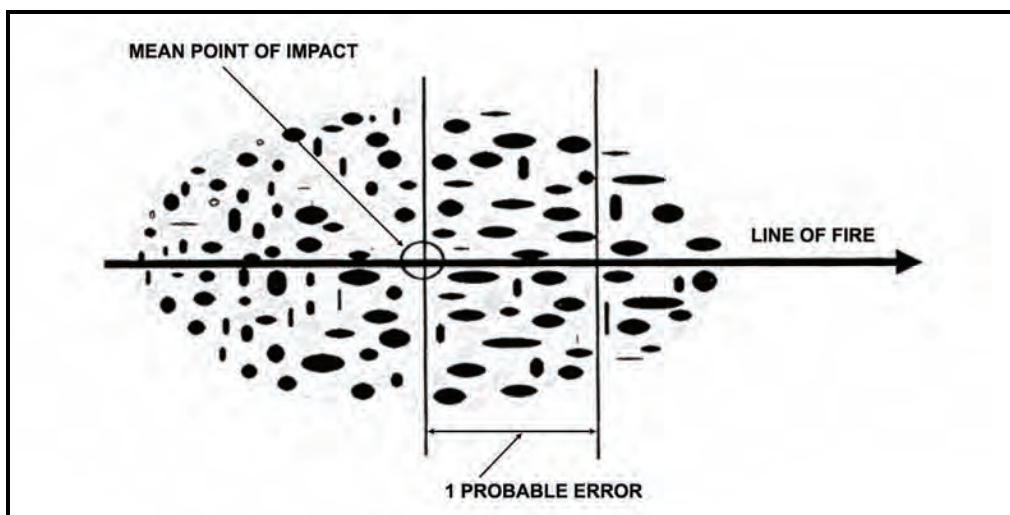

Figure 2-5. Burst in elliptical pattern.

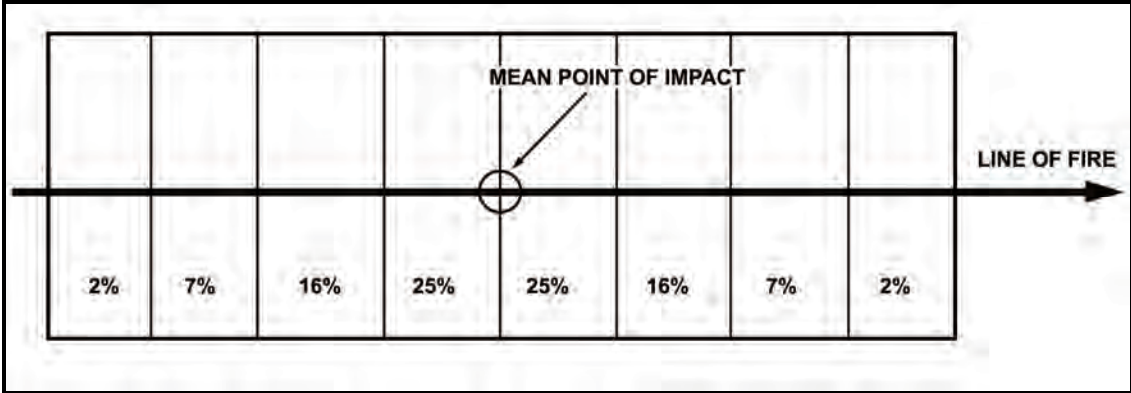

Figure 2-6. A 100-percent rectangle.

DISPERSION PATTERN

2-59. If one PE is used as the limit of measurement to divide the dispersion rectangle evenly into eight range zones, the percentage of rounds falling into each zone will be as shown in Figure 2-7. The percentages have been found to be true by experiment. Again, what is true in range is also true in deflection. If range dispersion zones and deflection dispersion zones are both considered, a set of small rectangles is created.

	0.02	0.07	0.16	0.25	0.25	0.16	0.07	0.02	
0.02	0.0004	0.0014	0.0032	0.0050	0.0050	0.0032	0.0014	0.0004	
0.07	0.0014	0.0049	0.0112	0.0175	0.0175	0.0112	0.0049	0.0014	
0.16	0.0032	0.0112	0.0256	0.0400	0.0400	0.0256	0.0112	0.0032	
0.25	0.0050	0.0175	0.0400	0.0625	0.0625	0.0400	0.0175	0.0050	
0.25	0.0050	0.0175	0.0400	0.0625	0.0625	0.0400	0.0175	0.0050	LINE OF FIRE →
0.16	0.0032	0.0112	0.0256	0.0400	0.0400	0.0256	0.0112	0.0032	
0.07	0.0014	0.0049	0.0112	0.0175	0.0175	0.0112	0.0049	0.0014	
0.02	0.0004	0.0014	0.0032	0.0050	0.0050	0.0032	0.0014	0.0004	

Figure 2-7. Dispersion rectangle.

PROBABLE ERROR

2-60. At some point along the line of fire, beyond the MPI, a second horizontal line can be drawn at right angles to the line of fire. This line divides rounds over into two equal parts (line AA, Figure 2-8). All rounds beyond the MPI manifest an error in range—they are all over. Some of the rounds falling over are more in error than others. If the distance from the MPI to line AA is a measure of error, half of the rounds over have a greater error, and half have a lesser error. The distance from the MPI to line AA becomes a convenient unit of measure. That distance is called one probable error in range (PE_r). A PE is the error exceeded as often as not. PE applies to short rounds, as well as to rounds to the left and right of the MPI.

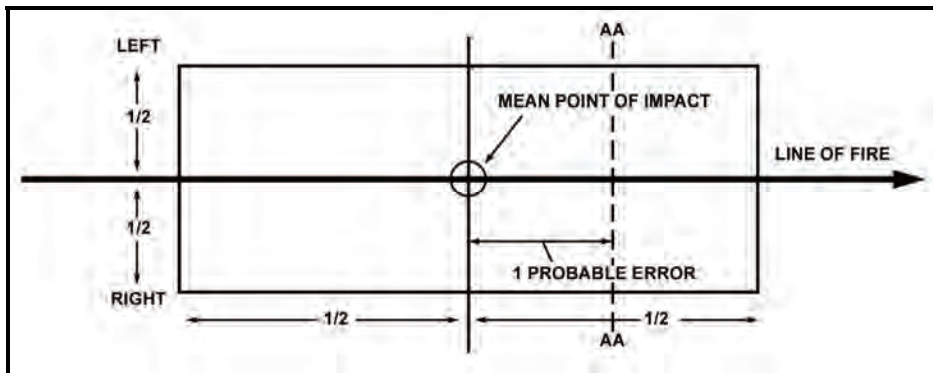

Figure 2-8. One probable error.

PROBABLE ERROR IN RANGE

2-61. The approximate value of the PE_r is shown in Table E, Supplementary Data, of the firing tables and can be taken as an index of the mortar's precision. Firing table values for PE_r s are based on the firing of specific ammunition under controlled conditions. The actual round-to-round PE_r experienced in the field is larger (Figure 2-9).

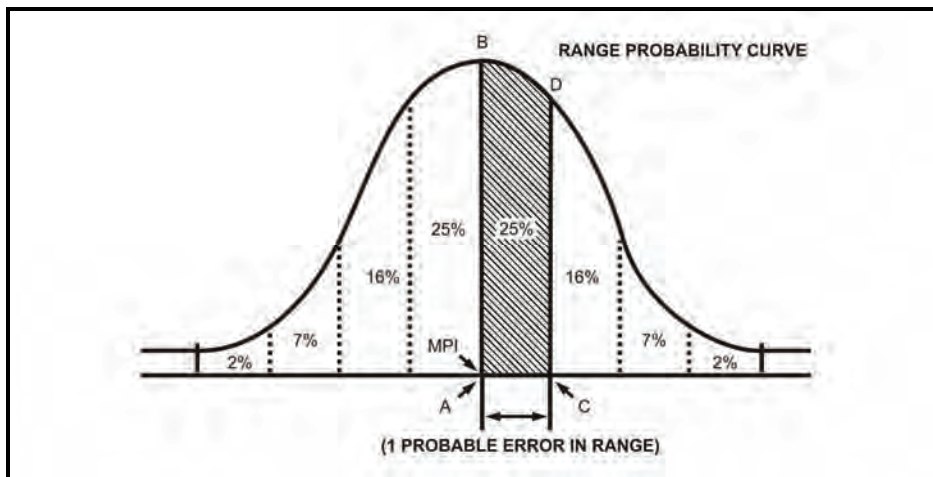

Figure 2-9. Range probability curve.

PROBABLE ERROR IN DEFLECTION

2-62. The value of the probable error in deflection (PE_d) is given in Table E, Supplementary Data, of the firing tables. For mortars, the PE_d is much smaller than the PE_r . For example, for a 120-mm mortar firing charge 4 at a range of 3,600 meters and elevation 1324, the PE_d is 25 meters (Figure 2-10). In other words, 50 percent of the projectiles fired will hit within 25 meters, 82 percent will hit within 50 meters (two PEs), and 96 percent will hit within 75 meters (three PEs) of the mean deflection.

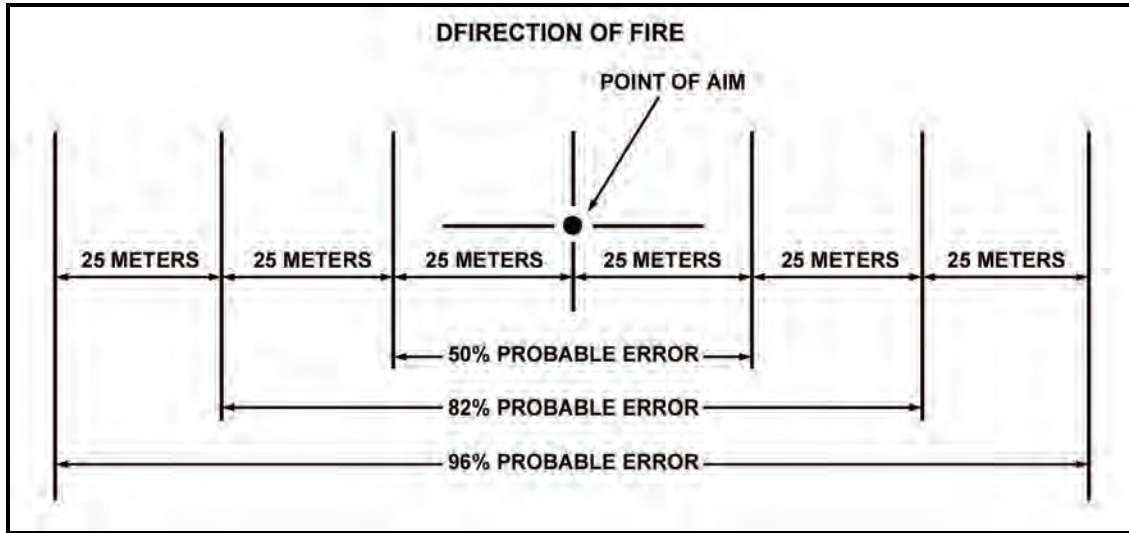

Figure 2-10. Probable error in deflection.

APPLICATION OF PROBABLE ERROR

2-63. Firing tables list PEs for range and deflection at each listed range. It is possible to express a given distance in terms of PEs and to solve problems using the dispersion scale or probability tables. To compute the probability of a round landing within an error of a certain magnitude, the specified error is reduced to equivalent PEs in one direction along the dispersion scale, and the sum is multiplied by two.

EXAMPLE

A 120-mm mortar has fired a number of rounds with charge 4, elevation 1245, and an MPI of at least 4,500 meters has been determined. What is the probability that the next round fired will fall within 50 meters of the MPI?

ANSWER

PE_r at 4,500 meters (charge 4) = 25 meters
 Equivalent of 50 meters in PEs ($50/25$) = approximately 2
 Percentage of rounds falling within 2 PEs = 25 percent plus 16 percent x 2 = 82 percent

SECTION III. FIRE PLANNING

Mortar platoons' ability to engage targets with accurate and sustained fires depends on the precision and detail of fire plans. Fire planning is concurrent and continuous at all levels of command. The principles of fire planning used by field artillery (FA) also apply to mortars. These principles are close and continuous support of the battalion, coordination with adjacent and higher units, and continuous planning.

TERMINOLOGY

2-64. Common terms used in fire planning include—

- Target.
- Targets of opportunity.
- Scheduled targets.
- On-call targets.
- Group of targets.
- Series of targets.
- Final protective fire (FPF).
- Preparation.
- Counterpreparation.
- Program of targets.
- Harassing and interdiction fires.

TARGET

2-65. A target is troops, weapons, equipment, vehicles, buildings, or terrain that warrants engagement by fire. Targets may be numbered for future reference and are designated on overlays as a solid cross with its center representing the center of the target. The target number consists of two letters and four numbers allocated by higher headquarters; this numbering system identifies the headquarters that planned the target, distinguishes one target from another, and prevents duplication.

TARGETS OF OPPORTUNITY

2-66. Targets of opportunity are targets for which fires have not been planned. Planned targets are scheduled or on-call.

Scheduled Targets

2-67. Scheduled targets are fired at a specific time before or after H-hour, or upon completion of a predetermined movement or task.

On-Call Targets

2-68. On-call targets are fired only upon request. They include targets for which firing data is kept current and those for which firing data is not prepared in advance; for example, a road junction (a prominent terrain feature) that the FO may use as a reference point.

GROUP OF TARGETS

2-69. Mortars are often assigned groups of targets. A group of targets consists of two or more targets to be fired upon at the same time. Groups of targets are graphically designated by a circle and a group designation (Figure 2-11). The group designation consists of the letters assigned to the maneuver brigade by the division tactical operations center (TOC), with a number inserted between them; for example, A1B for the first group of targets that the fires battalion FDC plans for a brigade assigned the letters A and B. The designation of a group of targets does not preclude firing upon individual targets within the group.

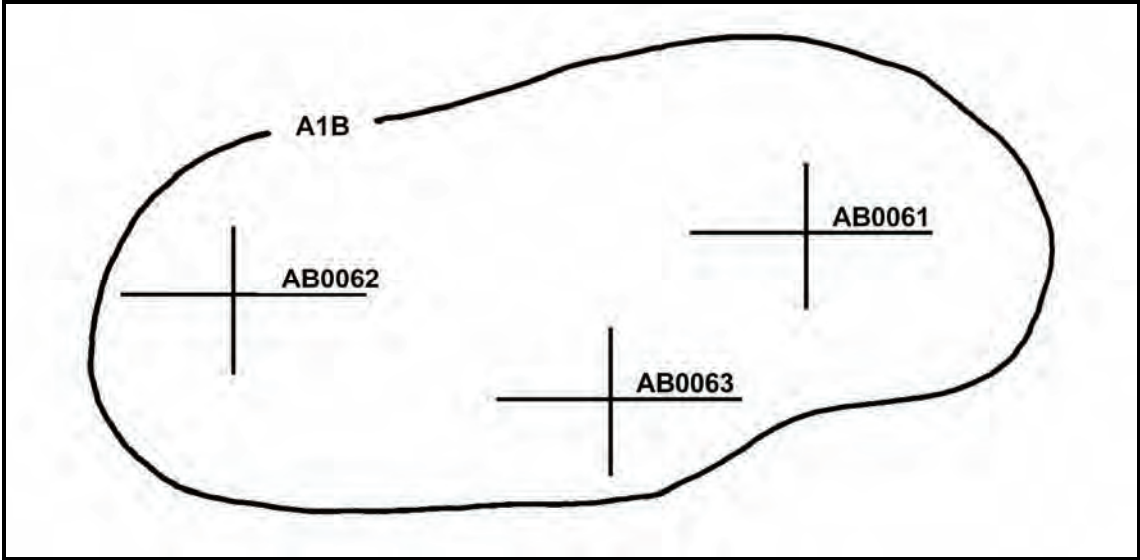

Figure 2-11. Group of targets.

SERIES OF TARGETS

2-70. A series of targets is a number of targets or groups of targets planned to support the operation (Figure 2-12). For example, a series of targets may be planned on a large objective so that fires are lifted or shifted as the support unit advances. Graphically, a series is shown as individual targets or groups of targets within a prescribed area. The series is given a code name. The designation of a series of targets does not preclude the attack of individual targets or groups of targets within the series.

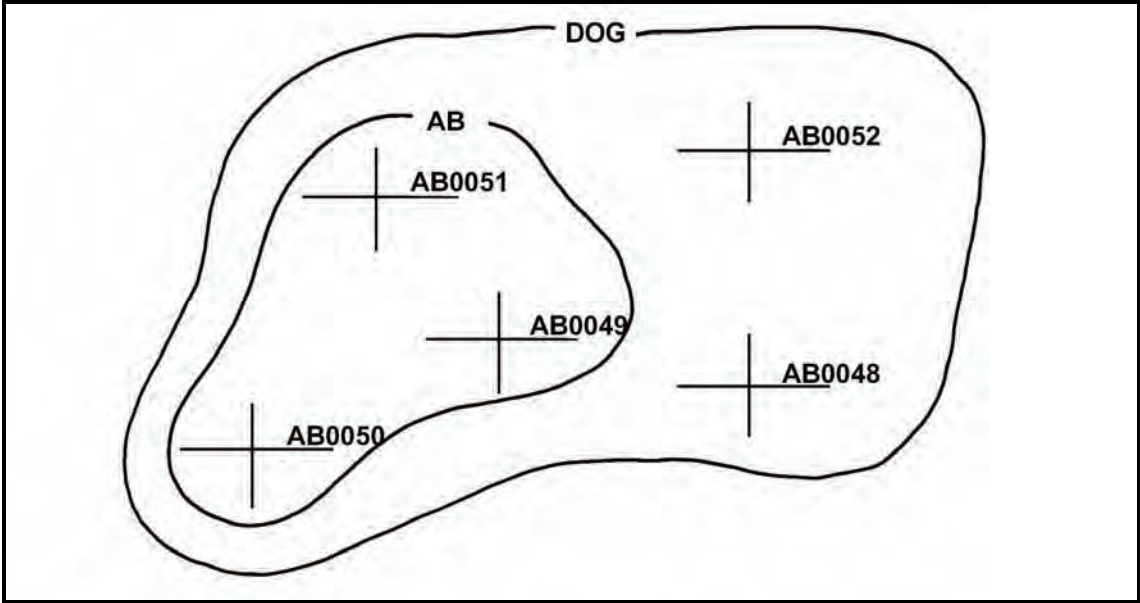

Figure 2-12. Series of targets.

FINAL PROTECTIVE FIRE

2-71. FPF is an immediately available prearranged barrier of fire designed to impede enemy movement across defensive lines or areas (Figure 2-13). It is integrated with the maneuver commander's defensive plans and may vary in shape and pattern to suit the tactical situation. On maps or firing charts, FPF is represented by a linear plot, with the unit designated to fire the FPF indicated above it. The length of the plot depends on the type of unit assigned to fire the FPF.

2-72. The maneuver commander determines the precise location of FPF, and the company FSO reports the desired location to the supporting FDC. Authority to call the FPF is vested in the maneuver commander (often the company commander or platoon leader) in whose area the FPF is located.

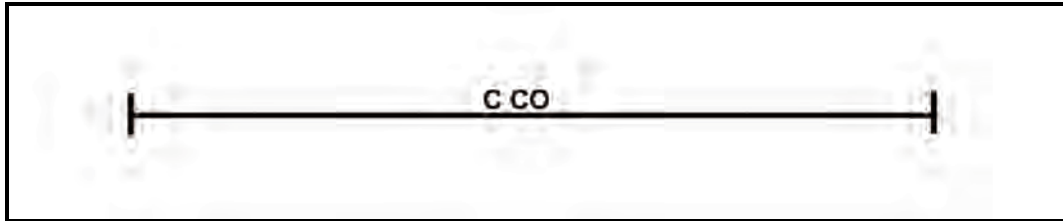

Figure 2-13. Final protective fires symbol.

PREPARATION

2-73. Preparation is the scheduled delivery of intense fires to support an attack. The commander decides to fire a preparation and orders the attack.

COUNTERPREPARATION

2-74. Counterpreparation is the delivery of intense planned fires when an enemy attack is imminent. It is designed to break up enemy formations, to disorganize command and communications systems, to reduce the effectiveness of enemy preparations, and to impair the enemy's offensive spirit.

2-75. Counterpreparation is fired on the order of the force commander. The fires are planned and assigned to firing units, and firing data are kept current.

PROGRAM OF TARGETS

2-76. A program of targets, such as a countermortar program, is a number of targets planned on similar areas. Although the artillery battalion in DS of the brigade plans counterpreparation and programs and designates groups and series of targets, the battalion mortar platoon and company mortar section that are assigned the targets are considered in the planning.

HARASSING AND INTERDICTION FIRES

2-77. Fires planned on known enemy positions to inflict losses, curtail movement, and disrupt the enemy to keep him off balance are called harassing fires. Interdiction fires are planned on critical areas (bridges, possible observation posts, road junctions) to deny the enemy use of those areas. Harassing and interdiction fires should include the number of rounds to be fired and the times of firing. Varying the number of rounds and firing at irregular intervals greatly increases the effectiveness of those fires.

TARGET CONSIDERATIONS

2-78. Planned targets include known, suspected, and likely enemy locations and prominent terrain features. These areas are determined through intelligence sources, knowledge of the situation, and map and terrain study. They are planned without regard to boundaries or weapon abilities. Duplication of effort will be resolved by the next higher headquarters.

KNOWN ENEMY LOCATIONS

2-79. Fires are planned on all known enemy locations that could hinder the support unit's mission.

SUSPECTED ENEMY LOCATIONS

2-80. Suspected enemy locations include probable operations, troop positions, assembly areas, avenues of approach, and routes of withdrawal. Fires are planned on suspected locations so that fires are available if the target is confirmed.

LIKELY ENEMY LOCATIONS

2-81. Targets in this category are determined from a careful study of the terrain and maps, and from knowledge of the enemy's methods of placing troops and weapons.

PROMINENT TERRAIN FEATURES

2-82. Hilltops, road junctions, manufactured objects, and other easily identifiable locations on a map and on the ground are planned as targets to provide reference points from which to shift to targets of opportunity.

SUPPORT OF OFFENSIVE OPERATIONS

2-83. Fires planned to support an attack consist of a preparation (if ordered) and subsequent fires. The preparation may be delivered before the assault elements advance from their line of departure (LD) and may continue for a short time thereafter. Fires planned for the preparation are limited to known targets and suspected areas. The delivery of fires on scheduled targets should be consistent with the threat imposed, time available for coordination, and availability of ammunition.

SUPPORT ARTILLERY

2-84. An artillery preparation is usually phased to permit successive attacks on certain targets. The phasing should be planned to provide for early domination of enemy fire support means, the attack of local reserves and command and control installations, and the attack of enemy forward elements, in that order. The detail and extent of preparation plans depend on the availability of intelligence.

BATTALION MORTAR PLATOON

2-85. The battalion fire plan table for a preparation may include fires by the battalion mortar platoon. Once the preparation is fired, the mortar platoon is available for fire support of the battalion maneuver elements. In some situations, the battalion commander may exclude the mortars from the preparation and retain them for targets of opportunity throughout the attack.

COMPANY MORTAR SECTION

2-86. The company mortar section may be required to fire preparation fires that are limited to the engagement of enemy forward elements. Before committing mortars to preparation fires, the commander should consider ammunition resupply and availability of mortars to quickly attack targets of opportunity.

FIRES SUPPORTING THE ATTACK

2-87. Fires planned to support the attack are shifted to conform to the movements of the supported unit. They are planned in the form of targets, groups of targets, and series of targets. They may be fired on a time schedule or on-call and may include targets from the LD to the objective, on the objective, and beyond the objective.

OBJECTIVES

- 2-88. Supporting fires have several objectives. They—
- Assist the advance of the supported unit by neutralizing enemy forces, weapons, and observation short of the objective.
 - Assist the supported unit in gaining fire superiority on the objective so that the assaulting force can close to assault distance.
 - Protect the supported unit during reorganization.
 - Fire upon on-call targets, such as likely assembly areas and routes for enemy counterattacks.
 - Provide supporting fires to prevent the enemy from reinforcing, supplying, or disengaging his forces.
 - Quickly provide mutual fire support to lower, adjacent, and higher headquarters.

SUPPORT OF DEFENSIVE OPERATIONS

- 2-89. Fires in support of defensive operations include—
- Long-range fires.
 - Close defensive fires.
 - FPF.
 - Fires within the battle area.

LONG-RANGE FIRES

2-90. Long-range fires are designed to engage the enemy as early as possible to inflict casualties, delay his advance, harass him, interdict him, and disrupt his organization. They consist of the fires of those supporting weapons within the battle area capable of long-range fires. Long-range weapons engage the enemy as soon as he comes within range. As a result, the volume of fire increases as the enemy continues to advance and comes within range of additional weapons.

CLOSE DEFENSIVE FIRES

2-91. Close defensive fires are supporting fires employed to destroy enemy attack formations before the assault.

FINAL PROTECTIVE FIRES

2-92. FPF are planned to prohibit or break up the enemy assault on the forward defense area. They consist of prearranged fires of supporting weapons to include machine gun final protective lines (FPL) and mortar and artillery FPF. Only those weapons whose FPF are in front of the threatened units fire their assigned fires; all other available weapons use observed fire to supplement or reinforce the FPF in the threatened area. To reinforce the FPF, direct-fire weapons engage those targets in front of the threatened area or others.

2-93. Artillery and mortar FPF are integrated with machine gun FPL. Each artillery battery fires one FPF. The mortar platoon may fire one or two FPF, but the platoon's fires are more effective in one FPF than in two.

2-94. DS artillery FPF are available to the supported brigade and its battalions. Typically, the FPF of any artillery reinforcing the DS battalion are available. The brigade commander designates general areas for available FPF or allocates them to maneuver battalions. The maneuver battalion commander, in turn, designates general locations or allocates them to maneuver companies.

FIRES WITHIN THE BATTLE AREA

2-95. The precise location of an FPF is the responsibility of the company commander in whose sector it falls. The exact locations of FPF within each forward company are included in the fire plan and reported to the battalion. Fires within the battle area are planned to limit penetrations and to support counterattacks.

FIRE SUPPORT COORDINATION MEASURES

2-96. The FIST and fire support planners use fire support coordination measures (FSCMs) to ensure that fires impacting in their zone will not jeopardize troop safety, interfere with other fire support means, or disrupt adjacent unit operations.

BOUNDARIES

2-97. Boundaries determined by maneuver commanders establish the operational zone for a maneuver unit and the area in which the commander fires and maneuvers freely. A unit may fire and maneuver against clearly identified enemy targets near or over its boundary, as long as such action does not interfere with adjacent units.

COORDINATION MEASURES

2-98. Coordination measures designate portions of the battlefield where actions may or may not be taken. The battalion or company FSO recommends FSCMs; the commander establishes them. FSCMs facilitate operations by establishing rules and guidelines for selected areas for a given time. There are two categories: permissive and restrictive.

Permissive Measures

2-99. Permissive measures allow fires into an area, such as a free-fire area or beyond a line; an example of such is a coordinated fire line (CFL) that need not be further coordinated as long as fires remain within the zone of the establishing headquarters and beyond the line. On overlays and maps, permissive measures are drawn in black, are titled, and indicate the establishing headquarters and the effective date-time group.

Coordinated Fire Line

2-100. A coordinated fire line is a line beyond which conventional surface fire support means— mortars, FA, and naval gunfire (NGF)—may fire any time (within the zone of the establishing headquarters) without further coordination.

Fire Support Coordination Line

2-101. A fire support coordination line (FSCL) is a line beyond which all targets may be attacked by any weapon system without endangering troops or requiring further coordination with the establishing headquarters. The effects of any weapon system may not fall short of this line.

Free-Fire Area

2-102. A free-fire area is a designated area into which any weapon system may fire without further coordination with the establishing headquarters.

Restrictive Measures

2-103. Restrictive measures mean that fires into an area or across a line must be coordinated with the establishing headquarters on a case-by-case basis. Graphically, they are drawn in red, are titled, and indicate the establishing headquarters and the effective date-time group.

- 2-104. Restrictive measures include—
- Restrictive fire areas.
 - No-fire areas.
 - Restrictive fire lines.
 - Airspace coordination areas (ACA).

Restrictive Fire Area

2-105. A restrictive fire area is an area in which specific restrictions are imposed and into which fires that exceed those restrictions will not be delivered without coordination with the establishing headquarters.

No-Fire Area

- 2-106. A no-fire area is an area in which no fires or effects of fires are allowed. There are two exceptions:
- When establishing headquarters approves fires temporarily within a no-fire area on a mission-by-mission basis.
 - When an enemy force within the no-fire area engages a friendly force, and the commander engages the enemy to defend his force.

Restrictive Fire Line

2-107. A restrictive fire line is a line established between converging friendly forces that prohibits fires or effects from fires across the line without coordination with the affected force.

Airspace Coordination Area

2-108. An ACA is a block of airspace in the target area in which friendly aircraft are reasonably safe from friendly surface fires. It may be a formal measure, but is usually informal.

COMPANY FIRE SUPPORT PLAN

2-109. The company commander's fire planning begins with the receipt or assumption of a mission and continues throughout mission execution. The company fire planning team consists of the company commander, the company FSO, the mortar section/platoon leader, and the platoon's FIST FOs. During the process of evaluating, refining, revising, and deciding how to accomplish the mission, the commander constantly seeks the most efficient and effective application of resources to produce maximum combat power. For best results, the commander should include the team in every step of his decision-making process.

2-110. As the commander's special staff officer for fire support, the company FSO performs a critical role in this planning process. He ensures that the commander has all required information about available fire support and recommends the best way to apply it in concert with other resources.

2-111. The company commander gives guidance to the fire planning team in the form of a concept. This concept outlines the scheme of maneuver and the desire for fire support. Later, when the company FSO submits the proposed consolidated target list and company fire plan, the company commander approves or changes it.

2-112. The company commander supervises the preparation of the company fire plan and coordinates fire planning activities. The company FSO develops the company fire plan and consolidates it with the target lists prepared by the platoon FOs. He then submits this consolidated list to the company commander for approval.

2-113. Company fire planners inform the company commander of the fire support available. They also obtain the following information for or from the company commander:

- Location of forward elements.
- Scheme of maneuver.
- Known enemy locations, avenues of approach, and assembly areas.
- Fires desired.
- Exact location of the company.
- Location of battalion mortar and artillery FPF.
- Location of the command post.

2-114. Upon receipt of this information, fire planners begin planning fires to support the company. Through map inspection and terrain analysis, they prepare the target lists (Table 2-1). If time and facilities permit, they also prepare an overlay giving a graphic representation. The target list includes the target number, map coordinates, description, and amplifying remarks for each target. It does not include target altitudes, which are determined by the respective FDCs.

Table 2-1. Consolidated target list.

TARGET NUMBER	DESCRIPTION	LOCATION	REMARKS
C-	FPF	14898346	
1-66	FPF	15508330	
1-45	FPF	15908330	
AA0050	DEFENSIVE TARGET	15278336	
AA0051	DEFENSIVE TARGET	15368319	
AA0052	HILLTOP	14848250	
AA0053	HILLTOP	15038196	
AA0054	CROSSROADS	15248171	
AA0055	RIDGE	15118081	
AA0056	MORTAR POSITION	152802	
AA0150	DEFENSIVE TARGET	14948381	
AA0152	DEFENSIVE TARGET	15008325	
AA0153	DEFENSIVE TARGET	15528303	
AA0154	OP	1428287	
AA0155	OP	15108245	
AA0156	HILL	15128286	
AA0157	EMERGENCY POSITION	161188288	
AA0158	ROAD JUNCTION	14608190	
AA0159	ROAD JUNCTION	15638160	
AA0160	ROAD JUNCTION	16308183	
AO7000	DEFENSIVE TARGET	15808424	
AC7001	DEFENSIVE TARGET	15818353	
AC7002	DEFENSIVE TARGET	15968320	
AC7003	ROAD JUNCTION	15728272	
AC7004	BRIDGE	152791	DESTROY ON CALL

2-115. Target information can be submitted to the FDC using any means available, such as telephone or radio. The company FSO assigns numbers to targets not included in the list from the platoon FO or mortar platoon leader. Then, the company FSO transfers numbers from the separate target lists to the corresponding targets on the approved consolidated target list/company fire plan and arranges the targets by target number, alphabetically, and numerically.

2-116. Once the company commander approves the fire plan, the company FSO distributes it to FOs, rifle platoon leaders, FDCs, company fire planners, and battalion operations and training officers (S3s). Also, he sends a copy of the approved target list to the FSO at battalion headquarters.

BATTALION FIRE SUPPORT PLAN

2-117. Fire planning at the battalion level is initiated the same way as in the company. The battalion fire planning team consists of the battalion commander, S3, battalion mortar platoon leader, and FSO. The battalion mortar platoon must always be directly responsive to the battalion commander's desires. The platoon leader assists the S3 in planning and obtaining fire support. The FSO is the battalion FSO, but the battalion mortar platoon leader serves in the absence of an FSO.

2-118. The battalion commander and S3 present the commander's concept of the operation, which (as in the case of the company) includes the scheme of maneuver and the plan for fire support. After the FSO has consolidated the target lists prepared by the company fire planners, the battalion commander approves the consolidated target list as part of the battalion fire support plan. The written plan becomes an annex to the operation plan.

2-119. The FSO receives target lists from the company FSO and from the battalion mortar platoon leader. Then, he deletes duplications and updates all fire plans by assigning target numbers or by consolidating targets. Then, the FSO submits all fire plans and target lists to the battalion S3 as the proposed battalion fire support plan.

2-120. The S3 ensures that the proposed fire support plan supports the scheme of maneuver. After the battalion commander approves the fire plan, the plan becomes an annex to the battalion operation plan. It is disseminated to all subordinate elements, such as rifle companies and the battalion mortar platoon.

SECTION IV. TARGET ANALYSIS AND ATTACK

When planning fires or deciding to engage a target, the company FSO ensures that the fire conforms to the support unit's scheme of maneuver. He must also be informed of the present enemy situation. When conducting a target analysis and determining the MOA, the FDC chief considers target description, registration data, size of attack area, and the maximum rate of fire.

TARGET DESCRIPTION

2-121. The method of attacking a target depends largely on its description, which includes the type, size, density, cover, mobility, and importance. Those factors are weighed against the guidelines established by the commander. The FDC then decides the type and number of projectiles, fuze, and fuze setting to be used.

2-122. Fortified targets must be destroyed by point-type fire using projectiles and fuzes appropriate for penetration. Mortar fire does not usually destroy armor, but it can harass and disrupt armor operations.

2-123. A target consisting of both men and materiel is normally attacked by area fire using air or impact bursts to neutralize the area. Flammable targets are engaged with HE projectiles to inflict fragmentation damage, and then with WP projectiles to ignite the material.

2-124. The method of attacking a target is governed by the results desired: suppression, neutralization, or destruction.

SUPPRESSION

2-125. Suppressive fires limit the ability of enemy troops in the target area to be an effective force. HE/PROX (proximity) creates apprehension or surprise and causes tanks to button up. Smoke is used to blind or confuse, but its effect lasts only as long as fires are continued.

NEUTRALIZATION

2-126. Neutralization knocks the target out of the battle temporarily. Ten percent or more casualties usually neutralize most units. The unit becomes effective again when casualties are replaced and equipment repaired.

DESTRUCTION

2-127. Destructive fires put the target out of action permanently. A unit with 30 percent or more casualties is usually rendered permanently ineffective, depending on the type and discipline of the force. Direct hits are required on hard materiel targets.

REGISTRATION AND SURVEY CONTROL

2-128. Firing corrections within the transfer limits should be maintained through registration, survey data, and current MET message. When those data are unavailable or inadequate, targets should be attacked with observed fire, since unobserved fires may be ineffective. Surveillance should be obtained on all missions to determine the results of the FFE. If accurate, firing for effect without adjustment is highly effective against troops and mobile equipment because damage is inflicted before the target can take evasive action. All destruction missions and missions fired at moving targets must be observed, and FFE should be adjusted on the target. (See Appendix D for more information.)

SIZE OF ATTACK AREA

2-129. The size of the attack area is determined by the estimated (based on intelligence and experience in similar situations) size of the target or the area in which the target is known or suspected to be located. The size of the attack area is limited when considering units to fire. Due to their versatility in making range changes and maintaining high rates of fire, mortars are the best weapons for engaging targets in depth. All mortars can fire traversing fires with minor manipulations.

MAXIMUM RATE OF FIRE

2-130. Surprise fire delivered with maximum intensity achieves the greatest effect, and massing the fires of several organic battalion units using time on target (TOT) procedures best attains intensity. The intensity of fires available is limited by each unit's maximum rate of fire and ammunition supply (Tables 2-2, 2-3, and 2-4). Maximum rates cannot be exceeded without danger of damaging the tube. To maintain rates to either neutralize a target or to attack a series of targets, mortars must be rested, or cooled, from previous firing. If not, heat can cause ignition of the increment or charges on a round before it reaches the bottom of the barrel. The lowest charge possible should be used during prolonged firing, since heating is more pronounced with higher charges.

Table 2-2. Rates of fire for the 60-mm mortar.

60-mm MORTAR, M224			
AMMUNITION TYPE	FUZE	MAXIMUM RATE OF FIRE	SUSTAINED RATE OF FIRE
M83A3 ILLUM	M65A1 PD	30 RPM for 1 minute	8 RPM
M302xx WP SMOKE	M935/M936 PD	30 RPM for 1 minute	8 RPM
M769 FRPC	M781 TRNG	30 RPM for 1 minute	8 RPM
M888 HE	M935 PD	30 RPM for 4 minutes	20 RPM
M720 HE	M734 MO	30 RPM for 4 minutes	20 RPM
M720A1HE	M734A1	30 RPM for 4 minutes	20 RPM
M722xx WP SMOKE	M745/M783 PD	30 RPM for 4 minutes	20 RPM
M721 ILLUM	M776 MTSQ	30 RPM for 4 minutes	20 RPM
M768 HE	M783 PD/DLY	30 RPM for 4 minutes	20 RPM
M767 IR ILLUM	M776 MTSQ	30 RPM for 2 minutes	15 RPM
M766 SRTP	M779 TRNG	N/A	N/A
PD = Point-Detonating		TRNG = Training	
MTSQ = Mechanical Time Superquick		FRTR = Full-Range Training Round	
DLY = Delay		SRTR = Short-Range Training Round	

Table 2-3. Rates of fire for the 81-mm mortar.

81-mm MORTAR M252			
AMMUNITION TYPE	FUZE	MAXIMUM RATE OF FIRE	SUSTAINED RATE OF FIRE
M821 HE	M734 MOF	30 RPM for 2 minutes	15 RPM
M821A1 HE	M734 MOF	30 RPM for 2 minutes	15 RPM
M821A2 HE (IM)	M734A1 MOF	30 RPM for 2 minutes	15 RPM
M889 HE	M935 PD	30 RPM for 2 minutes	15 RPM
M889A1 HE	M935 PD	30 RPM for 2 minutes	15 RPM
M853A1 ILLUM	M772 MTSQ	30 RPM for 2 minutes	15 RPM
M819 RP	M772 MTSQ	30 RPM for 2 minutes	15 RPM
M374xx HE	M524/5/6/7 PD	25 RPM for 2 minutes	8 RPM
M375A1 WP	M524/5/6/7 PD	25 RPM for 2 minutes	8 RPM
M301A3 ILLUM	M84 MTSQ	25 RPM for 2 minutes	8 RPM
M816 ILLUM	M772 MTSQ	30 RPM for 2 minutes	15 RPM
M879 FRTP	M751 TRNG	30 RPM for 2 minutes	15 RPM
M880 SRTP	M775 TRNG	N/A	N/A
M43/M362/M374 HE	M524/5/6/7 PD M716/7 PD	3 RPM (charge 8) 5 RPM (charge 6) for 1 minute	12 RPM (charge 8) for 2 minutes, 12 RPM (charge 6) for 5 minutes
PD = Point-Detonating		SRTR = Short-Range Training Round	
MTSQ = Mechanical Time Superquick		MOF = Multi-Option Fuze	
TRNG = Training		IM = Insensitive Munitions	
FRTR = Full-Range Training Round			

Table 2-4. Rates of fire for the 120-mm mortar.

120-mm MORTAR M120/M121			
AMMUNITION TYPE	FUZE	MAXIMUM RATE OF FIRE	SUSTAINED RATE OF FIRE
M91 ILLUM	M776 MTSQ	15 RPM for 1 minute	4 RPM
M933 HE	M745 PD	16 RPM for 1 minute	4 RPM
M934 HE	M734 MOF	16 RPM for 1 minute	4 RPM
M934A1 HE	M734A1 MOF	16 RPM for 1 minute	4 RPM
XM929 WP SMOKE	M745 PD	16 RPM for 1 minute	4 RPM
M929 WP SMOKE	M734A1 MOF	16 RPM for 1 minute	4 RPM
M930 ILLUM	M776 MTSQ	16 RPM for 1 minute	4 RPM
M983 IR ILLUM	M776 MTSQ	16 RPM for 1 minute	4 RPM
M931 FRPC	M751 TRNG	16 RPM for 1 minute	4 RPM
PD = Point-Detonating		FRTR = Full-Range Training Round	
MTSQ = Mechanical Time Superquick		MOF = Multi-Option Fuze	
TRNG = Training			

AMOUNT AND TYPE OF AMMUNITION

2-131. The amount of ammunition available is an important consideration when attacking targets. The controlled supply rate (CSR) should not be exceeded except by the authority of higher headquarters. When the CSR is low, units should fire only those missions that contribute the most to the supported units' mission. When the CSR is high, units may fire missions that include targets that affect planning or future operations and targets that require massing fires without adjustment.

2-132. The selection of a charge with which to engage a target depends on the elevation required. The range and terrain dictate the elevation. Hence, targets at great distances require the lowest elevations and greatest charges, while targets in deep defilade require the highest elevations. Targets in deep defilade and at great range are hard to engage. 60-, 81-, and 120-mm mortars vary both the elevation and charge, but attempt to stay at the lowest charge while varying the elevation.

2-133. The type of ammunition selected to engage a target depends on the nature of the target and the characteristics of the ammunition available.

- HE is used for destruction, harassing, interdiction, and neutralization fire. The effects of this ammunition vary depending on the type of fuze used.
- Red and white phosphorous ammunition is used for producing casualties, incendiary effects, screening, marking, and harassing.
- Visible and infrared illumination use a time fuze that gives an airburst depending on the time setting on the charge and elevation. The height of burst (HOB) can be adjusted to give the best illumination on the desired location.

QUICK AND SUPERQUICK FUZES

2-134. Quick and superquick (SQ) fuzes are used for impact detonation. When an HE projectile with a quick or SQ fuze passes through trees, detonation may occur in the foliage. Therefore, its effectiveness may be either improved or lost, depending on the density of the foliage and the nature of the target.

PROXIMITY FUZES

2-135. Proximity fuzes are used with HE ammunition to obtain airbursts. PROX or variable time (VT) fuzes detonate automatically when approaching the object and allow the user to obtain airbursts without adjusting the HOB. The HOB varies according to the caliber of projectile, the angle of fall, and the type of terrain in the target area. If the terrain is wet or marshy, the HOB is increased. Light foliage has little effect

on a proximity fuze, but heavy foliage increases the HOB by about the height of the foliage. The greater the angle of fall, the closer the burst is to the ground.

NOTE: If the proximity element fails to function, the fuze will operate as a superquick.

FUZE DELAY

2-136. Fuze delay produces a mine action caused by the round's penetration before detonation. The depth of the round's penetration depends on the type of soil and the round's terminal velocity. Fuze delay is effective against earth and log emplacements, some masonry, and concrete structures, but is not used against armor.

MULTIOPTION

2-137. With settings for delay, impact, near-surface burst, and proximity, the multioption fuze allows its user to select all types of fuzes. In the future, this fuze will replace all others.

M734A1

2-138. The air-powered M734A1 multioption fuze has four selectable functions:

- PRX 120 (4 meters/14 feet).
- PRX 60/81 (2 meters/7 feet).
- Impact (IMP).
- Delay (DLY).

2-139. In HE proximity mode, the HOB remains constant over all types of targets. The impact mode causes the round to function on contact with the target and is the first backup function for either proximity setting. In the delay mode, the fuze functions about 30 to 200 milliseconds after target contact. The delay mode is the backup for the impact and PRX modes. The impact and delay modes have not changed from the current M734 multioption fuze.

2-140. Radio frequency jamming can affect the functioning of proximity fuzes. Radio frequency jamming initiates a gradual desensitizing of the fuze electronics to prevent premature fuze function. Once the fuze is out of jamming range, the fuze electronics recover and function in the proximity mode if the designed HOB has not been passed. To limit the time of fuze radio frequency radiation, the proximity turn-on is controlled by an apex sensor that does not allow initiation of the fuze proximity electronics until after the apex of the ballistic trajectory has been passed.

2-141. In compliance with the safety requirements of military standard 1316C, the M734A1 uses ram air and setback to provide two independent environment sensors.

UNIT SELECTION

2-142. The unit selected for a mission must have weapons of the proper caliber and range to cover the target area quickly, effectively, and economically. If the unit selected to fire cannot mass its fires in an area as small as the target area, ammunition is wasted. Conversely, if a unit can cover only a small part of the target area at a time, surprise is lost during the shifting of fire. Also, the rate of fire for the area or number of mortars may not be adequate to achieve the desired effect. The factors that affect the selection of units and the number of rounds fired upon a target are discussed below.

AVAILABILITY OF MORTAR FIRE

2-143. When few mortar units are available, more targets must be assigned to each mortar unit.

SIZE OF THE AREA TO BE COVERED

2-144. The size of the area to be covered must be compared to the effective depth and width of the sheaf to be used by the platoon(s) available.

INCREASED AREA COVERAGE

2-145. Targets greater in depth or width than the standard sizes can be covered by—

- Increasing the number of units firing.
- Dividing the target into several targets and assigning portions to different firing elements.
- Shifting fire laterally with a single unit or with a number of units acting as a single fire unit.
- Traversing fire with each mortar covering a portion of the target.

CALIBER AND TYPE OF UNIT

2-146. The projectiles of larger calibers are more effective for destruction missions.

SURPRISE

2-147. To achieve surprise, a few rounds from many pieces are better than many rounds from a few pieces.

ACCURACY OF TARGET LOCATION

2-148. In certain circumstances, personnel may be unable to accurately locate important targets. Commanders ensure adequate coverage of these targets by having more than one unit fire upon a given target.

DISPERSION

2-149. At extreme ranges, the increasing PE causes mortar fire to be less dense, so more ammunition is required to effectively cover the target. When possible, the commander compensates for that dispersion by selecting a unit whose gun-target (GT) line coincides with the long axis of the target.

MAINTENANCE OF NEUTRALIZATION AND INTERDICTION FIRES

2-150. Neutralization and interdiction fires may be maintained using a few small units. A unit may fire other missions while it maintains these fires.

VULNERABILITY OF TARGETS

2-151. Some targets, such as truck parks and troops in the open, should be attacked rapidly with massed fires while they are vulnerable.

TYPICAL TARGETS AND METHODS OF ATTACK

2-152. Mortar targets should include enough enemy materiel, fortifications, and troops to justify ammunition expenditure (Table 2-5). Mortar fire is not effective against minefields and barbed wire; mines are detonated only by direct hits (the mortar is an indirect fire weapon), and breaching barbed wire requires extravagant amounts of ammunition.

Table 2-5. Targets and methods of attack.

TYPE OF TARGET	TYPE OF ADJUSTMENT	PROJECTILE	FUZE	TYPE OF FIRE	REMARKS(SEE FOOTNOTES)
GROUP I					
Vehicles (Rendezvous)	Observed, Unobserved	HE, WP	IMP	Neutralization, Destruction	(1), (2), (3)
Vehicles (Moving)	Observed	HE, WP	IMP	Neutralization, Destruction	(2), (3), (5) TOT missions are most effective.
Weapons (Fortified)	Observed	HE	Delay	Neutralization, Destruction	Airbursts are desirable if the weapon is firing. After the weapon has been silenced, it is attacked for destruction. Choice of fuze is determined by the type of fortification. (4)
Weapons (In Open)	Observed	HE, WP	PROX	Neutralization, Destruction	(1), (2), (3)
GROUP II					
Personnel (In Open)	Observed, Unobserved	Observed, Unobserved	PROX	Neutralization, Harassing, Destruction	PROX fuze settings should be fired at the lowest practical charge, as the steep angle of fall gives better fragmentation. Intermittent fire is better than continuous fire. (1)
Personnel (In Dugouts or Caves)	Observed	HE, WP	PROX	Neutralization, Harassing, Destruction	Airbursts are necessary, but surprise is not. WP/RP are useful in driving soldiers out of holes and into the open.
<p>(1) Personnel should neutralize the area with HE projectiles (airbursts if practical); surprise is essential to producing casualties.</p> <p>(2) Personnel should attack materiel remaining in the area for destruction using the appropriate projectile and fuze.</p> <p>(3) Personnel should combine WP projectiles with HE when the target contains flammable material and when the smoke will not obscure adjustment.</p> <p>(4) Personnel should fire HE projectiles with a delay fuze setting at intervals to clear away camouflage, earth cover, and rubble.</p> <p>(5) Personnel should stop the vehicle's movement by establishing a deep bracket so that the target will not move out of the initial bracket during adjustment. Speed of adjustment is essential. If possible, personnel stop the column at a point where vehicles cannot change their route and where one stalled vehicle will cause others to stop. Vehicles moving on a road can be attacked by adjusting on a point in front of the vehicle (in the direction in which the vehicle is moving) and timing rounds so they arrive at that point when the vehicle is passing it. A firing unit or several units, if available, may fire at different points on the road at the same time.</p>					

Table 2-5. Targets and methods of attack (continued).

TYPE OF TARGET	TYPE OF ADJUSTMENT	PROJECTILE	FUZE	TYPE OF FIRE	REMARKS(SEE FOOTNOTES)
GROUP II (continued)					
Personnel (Under Light Cover)	Observed, Unobserved	HE	PROX, Delay	Neutralization, Harassing, Destruction	(4)
Roads and Railroads	Observed, Unobserved	HE	PROX, Delay	Neutralization	(3)
		HE	IMP	Destruction, Harassing, Interdiction	Critical points, defiles, fills, crossings, culverts, bridges, and narrow portions must be attacked. The DOF should coincide with the direction of the road.
Supply Installations	Observed, Unobserved	HE, WP	PROX	Neutralization, Destruction	(1), (3)
<p>(1) Personnel should neutralize the area with HE projectiles (airbursts if practical); surprise is essential to producing casualties.</p> <p>(2) Personnel should attack materiel remaining in the area for destruction using the appropriate projectile and fuze.</p> <p>(3) Personnel should combine WP projectiles with HE when the target contains flammable material and when the smoke will not obscure adjustment.</p> <p>(4) Personnel should fire HE projectiles with a delay fuze setting at intervals to clear away camouflage, earth cover, and rubble.</p> <p>(5) Personnel should stop the vehicle's movement by establishing a deep bracket so that the target will not move out of the initial bracket during adjustment. Speed of adjustment is essential. If possible, personnel stop the column at a point where vehicles cannot change their route and where one stalled vehicle will cause others to stop. Vehicles moving on a road can be attacked by adjusting on a point in front of the vehicle (in the direction in which the vehicle is moving) and timing rounds so they arrive at that point when the vehicle is passing it. A firing unit or several units, if available, may fire at different points on the road at the same time.</p>					

This page intentionally left blank.

Part Two

Fire Direction Center

Chapter 3

Introduction

This chapter contains information about the principles of fire direction, organization of FDCs, and duties and responsibilities of FDC personnel.

PRINCIPLES OF FIRE DIRECTION

3-1. Fire direction is the tactical and technical employment of firepower, the exercise of tactical command of one or more units in the selection of targets, the massing or distribution of fire, and the allocation of ammunition for each mission.

3-2. Fire direction also includes the methods and techniques FDCs use to convert CFFs into proper fire commands. The FDC is the element of the mortar platoon headquarters that controls the fire of a mortar section and relays information and intelligence from observers to higher headquarters. Tactical fire direction involves the FDC's control of mortars in the selection of targets, the designation of units to fire, and the allocation of ammunition for each mission.

3-3. Fire direction methods must ensure—

- Close, continuous, accurate, and timely indirect fire support in all types of weather, visibility, and terrain.
- Flexibility to engage all targets within the company's or battalion's area of responsibility.
- The ability to engage two or more targets at the same time.
- The ability to implement independent gun operation.

ORGANIZATION

3-4. The FDC is the element of the indirect fire team that receives the CFF from the FO, company FSO, or higher headquarters; determines firing data; and announces fire commands to the firing section(s). The FDC also determines and applies corrections to chart data and to standard firing table values to achieve accuracy in firing. The FDC normally produces firing data, but this data may be produced by a firing unit operating as a GUN/FDC, if the FDC is unavailable or not assigned. Accuracy, flexibility, and speed of fire missions depend on—

- Accurate and rapid computation of firing data from the MBC and plotting board.
- Clear transmission of commands to the mortar section.
- Accurate and rapid verification of firing data.
- Efficient division of duties.
- Adherence to standard techniques and procedures.
- Efficient use of FDC plotting equipment and other data-determining devices.
- Teamwork and operating in a specified sequence.
- Efficient use of communications, including the FDC switchboard.

PERSONNEL DUTIES

COMMANDER

3-5. Commanders are responsible for the unit's training; they must ensure that FDC personnel are certified to perform their duties. (See Appendix E for more information.)

FDC DUTIES

3-6. The FDC of an 120-mm mortar section consists of—

- One section sergeant.
- One chief computer.
- One check computer.
- One driver/radio-telephone operator (RTO).

3-7. The FDC of an 81-mm mortar platoon consists of—

- One section sergeant.
- Two computers.
- One driver/RTO.

Fire Direction Chief/Section Sergeant

3-8. As the senior enlisted member of the FDC, the fire direction chief (chief computer/section sergeant) plans, coordinates, and supervises all FDC activities and is responsible for the training of all FDC members. The fire direction chief must be able to operate all FDC equipment, as well as supervise equipment operation.

3-9. The fire direction chief/section sergeant also—

- Makes the decision to fire. When a target is reported, the fire direction chief/section sergeant examines its location relative to friendly troops, boundary lines, no-fire lines, and fire coordination lines. Using that information, along with the nature of the target, the ammunition available, and the policy of the commander, he decides whether to fire. If he decides to engage the target, he uses that information to decide how to do so.
- Issues the FDC order. Once the fire direction chief/section sergeant decides to engage a target, he issues the FDC order to tell other FDC members how the mission will be conducted.
- Verifies corrections and commands. The fire direction chief/section sergeant verifies firing corrections obtained from a registration or a MET message before they are applied. He also cross-checks all firing data and fire commands sent to the mortar section to eliminate errors and resolves any discrepancies.
- Determines the altitude of a target from the map and announces it immediately after the FDC order so that the computers may compute and apply any altitude correction.
- Maintains records for all fire missions and all corrections to be applied.
- Evaluates and relays target surveillance data and intelligence reports from observers.
- Coordinates with the company FSO regarding sectors of responsibility and up-to-date tactical information. If the FDC receives a CFF for a target it cannot engage immediately or effectively, the fire direction chief/section sergeant informs the company FSO so that the mission can be assigned to another firing element.

3-10. In addition to the duties that the chief computer of a 120-mm mortar platoon performs, the section sergeant of an 81-mm mortar FDC—

- Supervises tactical deployment of mortar squads.
- Selects sites for tactical employment of mortar squads.
- Supervises the laying of the mortar section.
- Supervises the section during fire missions.

Fire Direction Computer Personnel

3-11. To reduce errors, increase speed and efficiency, and allow for the platoon or section to be split to fire multiple missions, all mortar sections, except that of the 60-mm mortar, have two fire direction computer personnel. In 81- and 120-mm mortar sections, one acts as a RTO for communication with the observers, while the other relays fire commands to the section. FDC personnel cross-train in computer skills to allow rotation for round-the-clock operations.

3-12. The FDC uses the MBC, MFCS, or LHMBC to convert observer data into fire commands. These commands are then reported to the firing section. Under other circumstances, FDC personnel might use the M16 (an alternate means of fire control for all mortars) or M19 (an alternate means of fire control for 60-mm mortar sections) plotting board. To prevent errors in the FDC, personnel cross-check their information using two MBCs or two M16/M19 plotting boards at all times. Neither the MFCS nor the LHMBC require a check computer for firing.

3-13. Computer personnel—

- Prepare and maintain an MBC or plotting board for plotting targets and producing firing data.
- Plot target locations called in by an observer and update them with observer corrections.
- Determine and announce the gun(s) to fire, number of rounds, deflection, charge, and elevation.
- Determine the size of angle T and announce it to the observer when angle T exceeds 500 mils or when requested.
- Number and replot targets for future reference.
- Compute and apply registration and MET corrections.
- Plot the location of friendly elements, supported unit boundaries, observers, no-fire lines, and safety limits in the MBC or on the M16/M19 plotting board.
- Maintain DA Forms 2188-R (Data Sheets) with current firing information about all targets.

Driver/Radio-Telephone Operator

3-14. In the FDC, the RTO drives the FDC vehicle. He must be trained in communication procedures, as well as in the duties of the computer personnel.

3-15. The driver/RTO also—

- Operates the telephones and radios within the FDC.
- Repeats CFFs received from an observer.
- Issues the message to the observer.

This page intentionally left blank.

Chapter 4





Major Concerns of the Fire Direction Center

This chapter discusses the methods and techniques that FDCs use to convert CFFs into proper fire commands.

TYPES OF SHEAVES

- 4-1. When the mortar section or platoon engages a target, it can use different sheaves depending on the type of target being engaged.
- 4-2. These types of sheaves include—
 - Parallel sheaf.
 - Converged sheaf.
 - Open sheaf.
 - Special sheaf.
 - Linear (standard) sheaf.
- 4-3. Table 4-1 outlines the types of sheaves used for a given target and provides additional information.

Table 4-1. Types of sheaves.

TYPE OF SHEAF	TYPE OF TARGET	RELATED INFORMATION
<p>Parallel sheaf</p> 	<p>Area targets</p>	<p>To fire a parallel sheaf, two or more mortars fire the same deflection, elevation, and charge, with the distance between the impacts of rounds being the same as the distance between the mortars.</p>
<p>Converged sheaf</p> 	<p>Point targets, such as bunkers or machine gun positions</p>	<p>When firing converged sheaves, mortar sections or platoons fire two or more mortars (each firing a different deflection) to impact the same target.</p>
<p>Open sheaf</p> 	<p>Targets that are wider than a linear sheaf</p>	<p>The distance between impacts of rounds from two or more mortars is one and a half times the distance between the bursts of rounds in a linear sheaf. Normally, 60-mm mortar rounds impact 30 meters apart, 81-mm rounds impact 40 meters apart, and 120-mm rounds impact 70 meters apart. For example, in an open sheaf with 60-mm mortars, rounds would impact 45 meters apart, one and a half times the distance that separates 60-mm mortar rounds in a linear sheaf. All mortars fire different deflections for an open sheaf.</p>
<p>Special sheaf</p> 	<p>Targets that are linear in nature such as roadways, bridges, and forward lines of troops (FPF)</p>	<p>A special sheaf is normally used in attitude missions and when needed for the FPF.</p> <p>Each mortar has a certain point to engage. The mortars may have different deflections and elevations.</p>
<p>Linear (standard) sheaf</p> 	<p>Standard engagement against enemy formations</p>	<p>With the linear sheaf, rounds impact within the total effective width of the bursts, regardless of the mortar formation.</p>

COMPUTER'S RECORD

4-4. DA Form 2399-R (Computer's Record) (Figure 4-1) is a form used to record—

- The FO's CFF and corrections.
- Firing data.
- Commands to the mortars during a fire mission.

4-5. The FDC uses this form to record each mission that the FDC receives and fires. This section provides instructions on how to complete a DA Form 2399-R.

NOTE: For a blank, reproducible copy of DA Form 2399-R, see the back of this publication.

COMPUTER'S RECORD											
For use of this form, see FM 3-22.91; the proponent agency is TRADOC											
ORGANIZATION <i>BCO 1/29 IN</i>			DATE		TIME <i>1401</i>		OBSERVER ID <i>A59</i>		TARGET NUMBER <i>BD0504</i>		
<input checked="" type="checkbox"/> ADJUST FIRE <input type="checkbox"/> FIRE FOR EFFECT <input type="checkbox"/> IMMEDIATE SUPPRESSION			SHIFT FROM <i>RPI</i>			POLAR			DT DIRECTION _____ ALTITUDE _____		
GRID _____			DT DIRECTION <i>0720</i>			DISTANCE _____			DT DIRECTION _____ ALTITUDE _____		
DT DIRECTION _____			<input type="checkbox"/> LEFT / <input checked="" type="checkbox"/> RIGHT <i>300</i>			<input type="checkbox"/> UP / <input type="checkbox"/> DOWN			<input type="checkbox"/> UP / <input type="checkbox"/> DOWN		
ALTITUDE _____			<input checked="" type="checkbox"/> ADD / <input type="checkbox"/> DROP <i>700</i>			VERTICAL ANGLE <input type="checkbox"/> +1 <input type="checkbox"/> -1					
ALTITUDE _____			<input type="checkbox"/> UP / <input checked="" type="checkbox"/> DOWN <i>120</i>								
TARGET DESCRIPTION <i>DLT IN OPEN</i>						METHOD OF CONTROL					
METHOD OF ENGAGEMENT						MESSAGE TO OBSERVER					
FOC ORDER			INITIAL CHART DATA			INITIAL FIRE COMMAND			ROUNDS EXPENDED		
MORTAR TO FFE <i>SEC</i>			DEFLECTION <i>0548</i>			MORTAR TO FOLLOW <i>SEC</i>			① <i>HE</i>		
MORTAR TO ADJ <i>#2</i>			DEFLECTION CORRECTION <input type="checkbox"/> L <input checked="" type="checkbox"/> R <i>18</i>			SHELL AND FUZE <i>HEQ</i>					
METHOD OF ADJ <i>1RD</i>			RANGE <i>3275</i>			MORTAR TO FIRE <i>#2</i>					
BASIS FOR CORRECTION <i>RPI</i>			VIALT CORRECTION <i>50</i>			METHOD OF FIRE <i>1 RD IN ADJ</i>					
SHEAF CORRECTION			<input type="checkbox"/> + <input checked="" type="checkbox"/> - <i>25</i>			3 RDS PROX IN FFE					
SHELL AND FUZE <i>HEQ IN ADJ</i>			RANGE CORRECTION <input type="checkbox"/> + <input type="checkbox"/> -			DEFLECTION/AZMUTH <i>0530</i>					
METHOD OF FFE <i>3 RDS</i>			CHARGE/RANGE <i>6/3150</i>			CHARGE <i>6</i>					
RANGE LATERAL SPREAD			AZIMUTH <i>0640</i>			TIME SETTING					
TIME OF OPENING FIRE <i>W/R</i>			ANGLE T <i>80</i>			ELEVATION <i>0969</i>					
OBSERVER CORRECTION			CHART DATA			SUBSEQUENT COMMANDS					
DEV	RANGE	TIME (HEIGHT)	DEFL	CHARGE (RANGE)	MORTAR FIRE	METHOD FIRE	DEFL AZMUTH	RANGE	CHARGE	TIME (SETTING)	ELEV
<i>L200</i>	<i>-200</i>		<i>0580</i>	<i>3325</i>			<i>0562</i>	<i>3300</i>		<i>0944</i>	<i>HE</i>
			<i>FFE</i>	<i>0580</i>	<i>3325</i>	<i>SEC</i>	<i>3 RDS PROX</i>	<i>0562</i>	<i>3300</i>	<i>0944</i>	<i>PROX</i>
						<i>EDM EST 50% CAS-</i>					

Figure 4-1. Example of completed DA Form 2399-R (Computer's Record).

ORGANIZATION

4-6. In this field, the FDC documents the unit that fires the mission.

DATE

4-7. In this field, the FDC records the date that the mission is fired.

TIME

4-8. The FDC uses this field to document the time that the mission was received (the CFF recorded).

OBSERVER IDENTIFICATION

4-9. In the observer identification (ID) field, the FDC records the observer's call sign.

NUMBER TARGET

4-10. In this field, the FDC records the number assigned to the mission.

WARNING ORDER

4-11. The FDC uses this field to document the type of warning order used for the mission, such as adjust fire, FFE, or immediate suppression.

TARGET LOCATION

4-12. In this field, the FDC records the method used to locate the target, such as grid, shift from a known point, or polar plot.

TARGET DESCRIPTION

4-13. In this field, the FDC provides a detailed description of the target (type, size, number, and protection).

METHOD OF ENGAGEMENT

4-14. The FDC records the types of adjustment and ammunition in this field. (For more information, see FM 6-30.)

METHOD OF CONTROL

4-15. In this field, the FDC documents the adjustment gun (when named by the FO) and time of delivery. (For more information, see FM 6-30.)

MESSAGE TO OBSERVER

4-16. The FDC records any messages sent to the FO in this field.

FDC ORDER

4-17. The chief computer/section sergeant usually completes the FDC order. This area describes how the mortars will engage the target. Table 4-2 highlights the fields found in this section and provides more information about each area.

Table 4-2. FDC order field titles and information documented in each field.

FIELD	INFORMATION DOCUMENTED IN FIELD
Mortar to FFE	The mortar(s) that will be used during the FFE phase of the mission
Mortar to ADJ	The mortar(s) that will be used during the adjustment phase of the mission NOTE: Leave this field blank if the "Mortar to ADJ" is the same as the "Mortar to FFE."
Method of ADJ	Number of rounds used by the adjusting mortar(s) for each correction during the adjustment phase of the mission
Basis for Correction	Point (usually the registration point [RP]) from which the correction factors to be applied are determined (surveyed chart only) and/or the latest meteorological corrections
Sheaf Correction	Type of sheaf, other than the default sheaf, that will be used during the FFE This is parallel for all fire control systems except the MFCS, which uses a default sheaf of linear.
Shell and Fuze	Shell and fuze combination that will be used for the mission The first line documents the ammunition that will be fired during the adjustment phase. The second line records the ammunition that will be fired in the FFE, if it changes from the adjustment round type. If different types of ammunition will be used during the mission, the different rounds are listed. Example: SHELL AND FUZE: HEQ in Adj, HEQ/WP in FFE
Method of FFE	Number and type of rounds for each mortar in the FFE phase of the mission Example: METHOD OF FFE: 2 Rds HEQ, 2 Rds WP
RG/Lateral Spread	Used with illumination, with one of the following: <ul style="list-style-type: none"> • RG spread (60-mm mortar, 250 meters between rounds; 81-mm mortar, 500 meters between rounds; and 120-mm mortar, 1,500 meters between rounds) • Lateral spread (60-mm mortar, 250 meters between rounds; 81-mm mortar, 500 meters between rounds; and 120-mm mortar, 1,500 meters between rounds) • RG/Lateral spread, which is a combination of range spread and lateral spread
Time of Opening Fire	The fire control for the mission given by the FO or FDC as "When ready" (W/R), "At my command" (AMC), or "Do not fire."

INITIAL CHART DATA

4-18. The FDC uses initial chart data to determine initial or subsequent fire commands. Table 4-3 highlights the fields found in this section and provides more information about each area.

Table 4-3. Initial chart data field titles and information documented in each field.

FIELD	INFORMATION DOCUMENTED IN FIELD
Deflection	Initial deflection from the mortar position to the target being engaged
Deflection Correction	Deflection correction used for the mission
Range	Initial chart range from the mortar position to the target being engaged
VI/ALT Correction	VI/altitude difference and VI correction used for the mission
Range Correction	The total range correction (TRC) used for the mission
NOTE: Deflection, deflection correction, range, VI/ALT correction, and range correction are calculated only when using the plotting board.	
Charge/Range	Charge and corrected range used for the mission
Azimuth	The azimuth from the gun position to the target
Angle T	Difference (in mils) between the gun-target (GT) line and the observer-target (OT) line NOTE: Determine this difference to the nearest 1 mil, record to the nearest 10 mils, and transmit to the nearest 100 mils.

INITIAL FIRE COMMAND

4-19. The initial fire command is the first fire command that the FDC sends to the mortar section for a mission. To complete the initial fire command, the computer must use the information contained in the initial chart data, any corrections, and the FDC order. Table 4-4 highlights the fields found in this section and provides more information about each area.

Table 4-4. Initial fire command field titles and information documented in each field.

FIELD	INFORMATION DOCUMENTED IN FIELD
Mortar to Follow	The mortar(s) to follow all commands or the mortar(s) that will be used in the FFE
Shell and Fuze	The shell and fuze combination used during the mission NOTE: If the mission is an adjustment mission, that is the round used during the adjustment.
Mortar to Fire	The mortar(s) to be used during the adjustment phase
Method of Fire	The number of rounds to be used for adjustment and in the FFE, and the type, if mixed Any control by the FDC would be placed here. For example, one round HEQ in adjustment; two rounds HEQ/two rounds WP in FFE, AMC; three rounds HEQ. Announcing the number of rounds in the FFE gives the ammunition bearer time to prepare those rounds in the event of, for example, an immediate suppression mission.
Deflection	The command deflection needed to fire the first round
Charge	The command charge needed to fire the first round
Time Setting	The time setting needed on mechanical time fuzes (normally illumination) to obtain the desired effects over the target area
Elevation	The elevation used to engage the target at a specific range with the given charge NOTE: The elevation is also the command to fire in the absence of fire control.

ROUNDS EXPENDED

4-20. The FDC uses this space to record the number of rounds fired for the initial fire command.

OBSERVER CORRECTION

4-21. The observer sends the observer correction to the FDC to move the impact of the round to the target. Table 4-5 highlights the fields found in this section and provides more information about each area.

Table 4-5. Observer correction field titles and information documented in each field.

FIELD	INFORMATION DOCUMENTED IN FIELD
Deviation (DEV)	The left/right correction (in meters) sent by the observer Example: "DEV: L 200" means the observer wants a "left 200 meters" correction.
Range (RG)	The add/drop correction (in meters) sent by the observer Example: "RG: Add 200" is recorded as +200, while "Drop 200" is recorded as "-200."
Height (Time)	The up/down (height) correction the observer wants Example: The observer will send "UP/DOWN: UP 200" or "DOWN 200" and record the same. NOTE: This element is usually used with illumination.

CHART DATA

4-22. The FDC obtains chart data from the M16/M19 plotting boards for the observer's requested corrections. Personnel use this section when firing corrections must be applied to chart data to obtain firing data. Table 4-6 highlights the fields found in this section and provides more information about each area.

NOTE: Disregard this portion of DA Form 2399-R when using the MBC.

Table 4-6. Chart data field titles and information documented in each field.

FIELD	INFORMATION DOCUMENTED IN FIELD
Deflection (DEFL)	The deflection read from the plotting board before any corrections are applied
Charge Range	Chart charge (or range) read from the plotting board before any corrections are applied

SUBSEQUENT COMMANDS

4-23. The FDC sends command data to the mortar(s) so they can fire the next round(s). Those commands, DEFL/CHG/ELEV, contain chart data and all firing corrections. In subsequent fire commands, only commands that change the initial fire command or the previous subsequent fire command are announced. Regardless of changes, the FDC always announces the elevation. Table 4-7 highlights the fields found in this section and provides more information about each area.

Table 4-7. Subsequent command field titles and information documented in each field.

FIELD	INFORMATION DOCUMENTED IN FIELD
Mortar to Fire	The mortars to fire a mission
Method of Fire	The number of rounds and type of fire
Deflection (DEFL)	The command deflection(s) to fire the round(s)
Range/Charge	60-, 81-, and 120-mm mortars: The command range used for this round(s) and the charge, if different from the preceding round NOTE: The range is recorded and used to determine the charge that is given to 60-, 81-, and 120-mm mortars (range is not given to guns).
Time Setting	The time setting needed for the mechanical time fuze
Elevation (ELEV)	The elevation used for this round(s) and the command to fire (in the absence of fire control)

DA FORM 2188-R (DATA SHEET)

4-24. The computer uses DA Form 2188-R (Data Sheet) (Figure 4-2) to record data that pertains to the mortar section or platoon and the firing data for each target engaged.

- NOTES:**
1. The controlling FDC will keep the DA Form 2188-R.
 2. For a blank, reproducible copy of DA Form 2188-R, see the back of this publication.

DATA SHEET																		
For use of this form, see FM 3-22.91 The proponent agency is TRADOC.																		
SETUP				WEAPON DATA								FO DATA						
TIME OUT: 60	UNIT: B 1/29IN	WPN: B1	WPN:	FO	ALT	GRID												
TGT PRFX: CA	B1 mm CAR: <input type="checkbox"/> YES <input checked="" type="checkbox"/> NO	DIR: 4800	DIR:	A59	500	0283 7417												
TGT NO: 0300-0400		DIS: 35	DIS:															
ALARM: <input type="checkbox"/> ON <input checked="" type="checkbox"/> OFF	BP: B2	WPN: B3	WPN:															
MIN E: 02	E: 0360	DIR: 1600	DIR:															
MIN N: 73	N: 7490	DIS: 35	DIS:															
GD: <input checked="" type="checkbox"/> E <input type="checkbox"/> W 02	ALT: 460	WPN: B4	WPN:															
LAT: <input checked="" type="checkbox"/> + <input type="checkbox"/> - 32	AZ: 3136	DIR: 1600	DIR:															
LISTEN: <input type="checkbox"/> ON <input checked="" type="checkbox"/> OFF	DEF: 2800	DIS: 70	DIS:															
BIT RATE: 1200	ELE:																	
KEY TONE: 1-4																		
BLK: <input checked="" type="checkbox"/> SNG <input type="checkbox"/> DBL																		
OWNER ID: B																		
AMMUNITION DATA																		
TEMPERATURE 70°	TYPE: <input checked="" type="checkbox"/> HE <input checked="" type="checkbox"/> WP <input checked="" type="checkbox"/> ILL <input type="checkbox"/> CS <input type="checkbox"/> TNG																	
LOT NUMBER	HE 6008	WP B00B	ILL A00B															
WEIGHT																		
ON HAND	200	100	50															
RECEIVED	100	50	25															
TOTAL	300	150	75															
ROUNDS EXPENDED	7																	
ROUNDS REMAINING	293																	
TARGET DATA																		
TARGET ID			CHART DATA		FIRING CORRECTIONS				FIRING DATA				INTELLIGENCE				ROUNDS	
TGT NO.	GRID	ALT	DEFL	RG CHG	DEFL CORR	RANGE CORR	ALT VI	ALT CORR	DEFL	RG CHG	FUZE TIME SETTING	ELEV	TIME FIRED	TARGET DESCRIPTION	METHOD OF ENGAGEMENT	SURVEILLANCE	EXP	REM
RPI	0831 7158	540					540 780	140	2817	8		0963		RPI	#2 TRD		7(NE)	293

DA FORM 2188-R, MAR 1991 REPLACES DA FORM 2188-R, MAR 1977 WHICH IS OBSOLETE. USAPA V1.00

Figure 4-2. Example of completed DA Form 2188-R (Data Sheet).

SETUP

4-25. The FDC uses this field to record the firing element's initialization data. Table 4-8 highlights the fields found in this section and provides more information about each area.

Table 4-8. Setup field titles and information documented in each field.

FIELD	INFORMATION DOCUMENTED IN FIELD
Time Out	The time that must elapse before the MBC enters standby mode
TGT PRFX	Target prefix used by the firing element
TGT NO.	Target numbering block
Alarm	Alarm on and off function for messages
MIN E/MIN N	Minimum easting and northing coordinates from the map sheet
GD	East or west grid declination
LAT	Latitude from the map sheet
Listen	Message transmission and reception
BIT Rate	Message transmission rates for digital message device (DMD)-supported missions
Key Tone	Length of time required for a communications device
BLK	Transmit block mode for DMD-supported missions
Owner ID	Owner identification for DMD-supported missions

WEAPON DATA

4-26. The FDC uses this field to record the firing element's weapon initialization data. Table 4-9 highlights the fields found in this section and provides more information about each area.

Table 4-9. Weapon data field titles and information documented in each field.

FIELD	INFORMATION DOCUMENTED IN FIELD
Unit	Unit mortar element assigned
__mm CAR	Weapon type, mounted or dismounted
BP	Basepiece number
E	Basepiece's easting map coordinate
N	Basepiece's northing map coordinate
ALT	Basepiece's altitude in meters
AZ	Basepiece's direction of fire in mils
DEF	Referred deflection used by the firing element
ELE	Elevation used for these rounds
WPN/DIR/DIS	Weapon number, direction, and distance from the basepiece
	NOTE: Continue to fill out until all weapons have been recorded for firing section.

FORWARD OBSERVER DATA

4-27. The FDC records the FO's location in this field. Table 4-10 highlights the fields found in this section and provides more information about each area.

Table 4-10. Forward observer data field titles and information documented in each field.

FIELD	INFORMATION DOCUMENTED IN FIELD
FO	FO's call sign
ALT	Altitude at the FO's location
GRID	Grid coordinates of the FO's location

AMMUNITION DATA

4-28. The FDC monitors the rounds using this section. After each mission, personnel update all fields. Table 4-11 highlights the fields found in this section and provides more information about each area.

Table 4-11. Ammunition data field titles and information documented in each field.

FIELD	INFORMATION DOCUMENTED IN FIELD
Temperature	Current temperature
Type	Appropriate types of ammunition issued
Lot Number	Lot numbers of the rounds and fuzes on hand
On Hand	Number (by lot number) of rounds the firing element has on the firing position
Received	Number and type of rounds received
Total	Combination of rounds on hand and those received
Rounds Expended	Number of rounds expended for missions
Rounds Remaining	Number of rounds remaining

TARGET DATA

4-29. The FDC records previously fired targets using this section.

Target Identification

4-30. Target identification (ID) includes the type of target; for example, troops in the open. Table 4-12 highlights the fields found in this section and provides more information about each area.

Table 4-12. Target identification field titles and information documented in each field.

FIELD	INFORMATION DOCUMENTED IN FIELD
TGT NO.	Alphanumeric identifier assigned to a target
GRID	Six- or eight-digit coordinates of a target
ALT	Altitude of the target

Chart Data

4-31. Chart data includes the fire solution without adjustment or modification. Table 4-13 highlights the fields found in this section and provides more information about each area.

Table 4-13. Chart data field titles and information documented in each field.

FIELD	INFORMATION DOCUMENTED IN FIELD
DEFL	Chart (M16/M19) or initial (MBC) deflection to the target
RG/CHG	Chart (M16) or initial (MBC) range and charge needed for the mortars to engage the target

Firing Corrections

4-32. This information is applied to the chart data. Table 4-14 highlights the fields found in this section and provides more information about each area.

Table 4-14. Firing correction field titles and information documented in each field.

FIELD	INFORMATION DOCUMENTED IN FIELD
DEFL CORR	Direction (left/right) value and number of mils to apply to the chart deflection for firing data
RG CORR	The value and amount (+/-) of meters to apply to the chart range for firing data
ALT VI	Altitude of the target and VI difference, UP (+) or DOWN (-) in meters, between the target and the mortar altitudes
ALT CORR	The number of meters and direction (UP/DOWN) used for altitude corrections NOTE: For 60-, 81-, and 120-mm mortars, corrections for deflection and range are used on the modified and surveyed charts.

NOTE: If the chart data and the command data are the same, do not repeat the data in the range/charge block.

Firing Data

4-33. Firing data includes the base gun command data for targets. This information combines corrections and chart data to calculate firing data (command data) so that mortars can fire to the target's center of mass. Table 4-15 highlights the fields found in this section and provides more information about each area.

Table 4-15. Firing data field titles and information documented in each field.

FIELD	INFORMATION DOCUMENTED IN FIELD
DEFL	Command deflection to hit the target's center of mass
RG/CHG	Command range and charge to hit the target
Fuze Time SETT	Fuze/time setting on mechanical/electronic fuzes, recorded to the nearest 0.1 second
ELEV	Elevation used to fire the round for 60-, 81-, and 120-mm mortars; the elevation from the firing tables for the command range

Intelligence

4-34. Intelligence combines information provided by the FO and the FDC. Table 4-16 highlights the fields found in this section and provides more information about each area.

Table 4-16. Intelligence field titles and information documented in each field.

FIELD	INFORMATION DOCUMENTED IN FIELD
Time Fired	The time the CFF was received NOTE: The FDC completes this field.
Target DESCR	What the target was (from the CFF on DA Form 2399-R) NOTE: The FO completes this field.
Method of Engagement	How the target was engaged (number of mortars, number and type of rounds fired in the FFE) NOTE: The FDC completes this field.
Surveillance	The battle damage assessment (BDA) of the engagement NOTE: The FO provides this information to the FDC.

Rounds

4-35. This section contains information regarding the rounds expended for the mission and the amount remaining for future missions.

GEOGRAPHICAL REFERENCE FIELD

4-37. The FDC uses the GEO REF field to record the geographical reference data. Table 4-17 highlights the fields found in this section and provides more information about each area.

Table 4-17. Geographical Reference field titles and information documented in each field.

FIELD	INFORMATION DOCUMENTED IN FIELD
Ellipsoid	Default is WGS1984, Set to <ALL> to view all data
Datum	When the Ellipsoid is set, the corresponding default datum is set.
Min Easting	Minimum easting coordinates from the map sheet
Min Northing	Minimum northing coordinates from the map sheet
Zone	Zone coordinates from the map sheet
Hemi	Set to North if north of the equator; set to South if south of the equator.

DATA FIELD

4-38. The FDC uses this field to record the firing element's setup data. Table 4-18 highlights the fields found in this section and provides more information about each area.

Table 4-18. Data field titles and information documented in each field.

FIELD	INFORMATION DOCUMENTED IN FIELD
TGT PRFX	Target prefix used by the firing element
MIN	The first number in the unit's designated target block
MAX	The last number in the unit's designated target block
Alarm	Alarm on and off function for messages
Next	The target number to be assigned to the next mission

WEAPON DATA FIELD

4-39. The FDC uses this field to record the firing element's weapon initialization data. Table 4-19 highlights the fields found in this section and provides more information about each area.

Table 4-19. Weapon Data field titles and information documented in each field.

FIELD	INFORMATION DOCUMENTED IN FIELD
Firing Unit	Unit mortar element assigned
mm CAR: Y/N	Weapon type, mounted or dismounted
Unit Name	Designation given to the specific weapon (for example, A1)
Easting/DIR	The easting portion of the grid coordinate or the direction to the mortar from the basepiece
Northing/DIS	The northing portion of the grid coordinate or the distance to the mortar from the basepiece
ALT	The mortar's altitude in meters
AZ	The mounting azimuth used by the firing element for degraded ops
DEF	Referred deflection used by the firing element for degraded ops
Obs Num	Observer number of the firing unit (if used)
	NOTE: Continue to fill out until all weapons have been recorded for firing section.

SUBSCRIBERS FIELD

4-40. The FDC records the observer(s) and additional friendly units' information in this field. Any unit with which the FDC wishes to digitally communicate must be on this list. Table 4-20 highlights the fields found in this section and provides more information about each area.

Table 4-20. Subscribers field titles and information documented in each field.

FIELD	INFORMATION DOCUMENTED IN FIELD
FDC IP	Supplied by Unit signal officer. This 12 digit address will set the first 9 digits of the IP Address' for all subscriber units.
Unit	Designation assigned to a given subscriber. First character must be a letter
URN	Unit Reference Number. Supplied by the units signal officer. The URN of the Force XXI battle command—brigade and below (FBCB2) computer and the URN of the MFCS are different, even though they refer to the same unit.
ADR	The last 3 digits of the 12 digit IP address for the subscriber
Grid	Grid coordinates of the subscribers location
Alt	Altitude at the subscribers location
Obs#	Observer number if the subscriber is acting as an observer

COMMO FIELD

4-41. The FDC records the communication information in this field. Table 4-21 highlights the fields found in this section and provides more information about each area.

Table 4-21. Commo field titles and information documented in each field.

FIELD	INFORMATION DOCUMENTED IN FIELD
Protocol	A220 for VMF PKG 11 or C220 for VMF R5
Device Type	Set to SINCGARS if using FM communications or 2-Wire for a hardwired connection.
Modulation	Either Non-Return to Zero(NRZ) or Frequency Shift Keying-FSK188C
Data Rate	Speed that data is transferred on the network, ranging from 75 to 1200 bps
COMSEC	Set to cipher text (CT) for secure communications or plain text (PT) for unsecured communications
FH Mode	Select FH for frequency hop or SC for single channel communications
EDC Mode	Error detection and correction mode Selectable modes include forward error correction, time-dispersal coding, and scrambling.
NAD Method	Deterministic adaptable priority network access delay (DAPNAD) (default), hybrid, priority random, or round-robin (LHMBC only)
NET Usage	Data or data and voice Voice will take priority on networks that are data and voice enabled, significantly increasing data transmission times.
# Stations	Number of stations using the network
Rank	Rank of the FDC in the network

AMMUNITION DATA FIELD

4-42. The FDC monitors the rounds using this section. This section is filled out in the same manner as DA Form 2188-R. See paragraph 4-28 for instructions.

TARGET DATA FIELD

4-43. The FDC records previously fired targets using this section. This section is filled out in the same manner as DA Form 2188-R. See paragraphs 4-29 through 4-35 for instructions.

ANGLE T

4-44. Angle T is the angle, or difference in mils, between the OT line and GT line (Figure 4-4). Angle T is not important to the FDC when computing, but the FDC notifies the FO if angle T is between 500 and 2700 mils so that the FO can cut his corrections in half to compensate for dispersion.

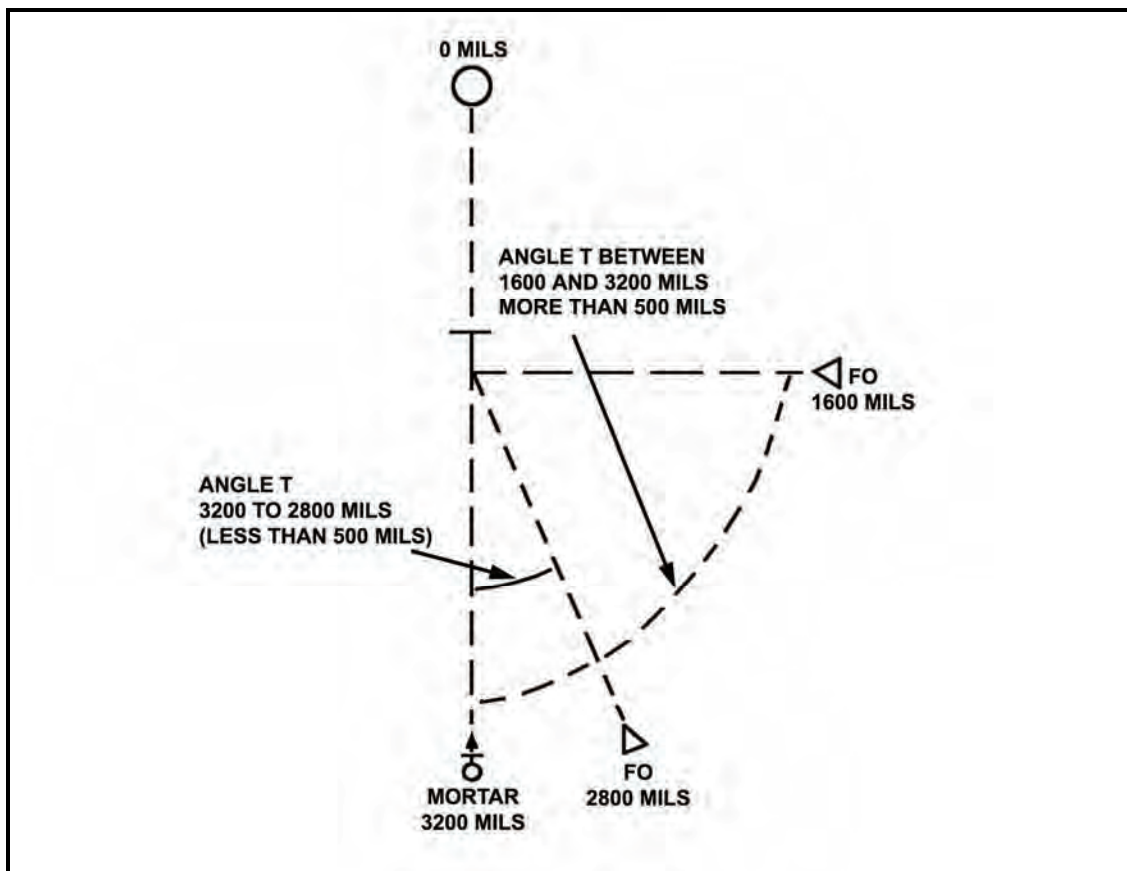

Figure 4-4. Angle T between 400 and 1600 mils.

4-45. The computer determines angle T to the nearest mil, records it to the nearest 10 mils, and announces it to the observer to the nearest 100 mils when requested or when it is 500 mils or greater. To determine angle T, the computer must compare the OT azimuth and GT azimuth, subtracting the smaller from the larger.

- GT azimuth is the azimuth that corresponds to the initial chart deflection of the target being engaged.
- OT azimuth is the azimuth that the observer gives in his CFF or with his first correction.

NOTE: For shift from a known point and polar plot missions, the FO must send the OT azimuth in the CFF. For grid missions, however, the FO may not send the OT azimuth in the CFF, but he must send it before or with the first subsequent adjustment.

EXAMPLE 1

If OT = 2950 mils and GT = 3190 mils, then $3190 - 2950 = 240$ mils (angle T).

EXAMPLE 2

Consider OT = 6210 mils and GT = 0132 mils. Because the azimuths are on either side of 6400 (0), subtracting the smaller from the larger would not yield the angle T. The computer must add 6400 to the smaller value, and then subtract from the larger value:

$$\begin{aligned} 0132 + 6400 &= 6532 \\ 6532 - 6210 &= 322, \text{ recorded as } 320 \end{aligned}$$

NOTE: Use this procedure only when one azimuth is between 0 (6400) and 1600, and one is between 4800 and 6400.

EXAMPLE 3

For an angle T exceeding 499 mils, subtract the smaller from the larger.

If OT = 1530 mils and GT = 810 mils, then $1530 - 810 = 720$ mils (angle T).

4-46. Because angle T exceeds 499 mils in the third example above, the FDC notifies the observer so that he can use this information to make any corrections. When angle T exceeds 499 mils, the FO continues to use the OT factor to make deviation corrections (Figure 4-5), but if the correction is more than asked for, he reduces the deviation corrections proportionately.

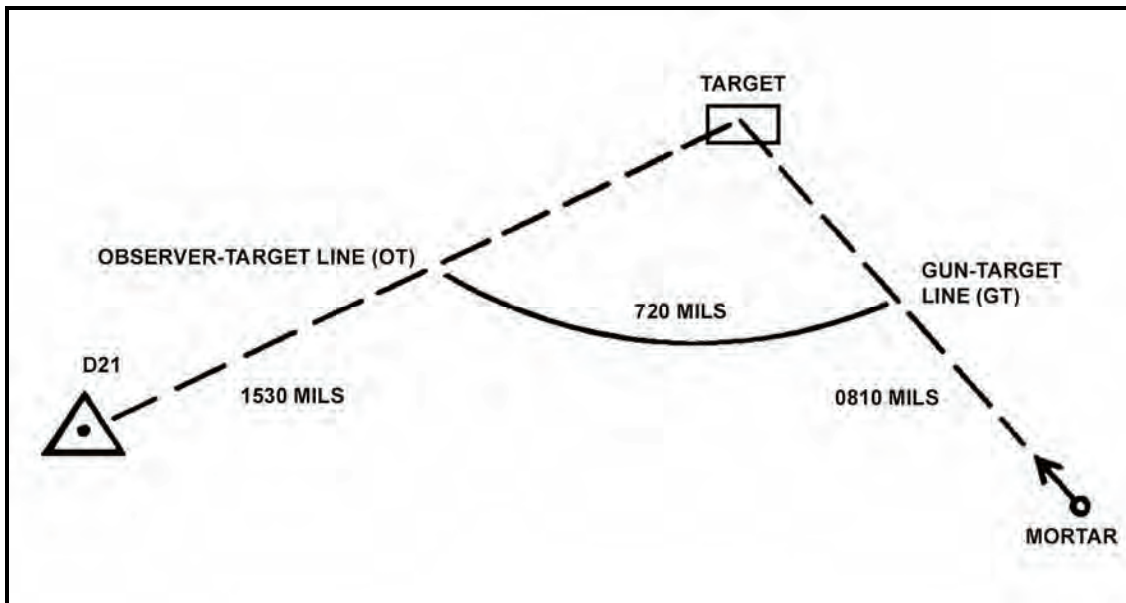

Figure 4-5. Angle T exceeding 499 mils.

FIRING TABLES

4-47. Firing tables contain data based on standard and nonstandard trajectories for a given weapon and combination of cartridge, fuze, and propelling charge.

- A standard trajectory, fired at a given elevation, theoretically exists under arbitrarily chosen conditions of weather and material.
- A nonstandard trajectory exists under conditions of weather and material differing from standard conditions.

NOTE: Refer to the appropriate firing tables for rounds not listed in this manual.

4-48. The following information describes the firing table for a 60-mm mortar. An example is shown in Figure 4-6.

- Parts I, II, III, and IV of FT 60-P-1 contain firing data for various rounds that use propelling charges. Each part contains five tables:
 - Table A provides the components of a 1-knot wind.
 - Table B provides air temperature and density corrections.
 - Table C provides variations in muzzle velocity due to propellant temperature.
 - Table D provides basic data and nonstandard correction factors.
 - Table E provides supplementary data.
- Each part addresses a given round:
 - Part I includes the M720 HE round.
 - Part II includes the M49A4 HE round.
 - Part III includes the M302A1 WP round.
 - Part IV includes the M83A3 illumination round.
 - The appendices contain trajectory charts for the M720 HE round.
- FT-6-Q-1 contains information for M49A4 HE, M50A3 training practice, M302A1 WP, and M83A3 illumination rounds for the M31 subcaliber assembly.

CHARGE 2		TABLE D BASIC DATA							FT 60-P-1 CTG, HE, N720 FUZE, NO, N734	
1	2	3	4		5	6	7			
R A N G E	E L E V	D E L E V P E R 100 M O R	APPROX NO. OF TURNS PER 100 M O R		L I N E N O.	T I M E O F F L I G H T	A Z I M U T H C O R R E C T I O N			
			U S	L S				C U O F 1 K N O V		
N	MIL	MIL				SEC	MIL			
1100	1314	28	3	2	3	30.2	3.2			
1125	1307	28	3	2	3	30.1	3.2			
1150	1300	29	3	2	3	30.1	3.1			
1175	1293	29	3	2	3	30.0	3.0			
1200	1286	29	3	2	3	30.0	2.9			
1225	1278	29	3	2	3	29.9	2.9			
1250	1271	30	3	2	3	29.9	2.8			
1275	1264	30	3	2	3	29.8	2.7			
1300	1256	30	3	2	3	29.7	2.7			
1325	1248	31	3	2	3	29.7	2.6			
1350	1241	31	3	2	3	29.6	2.6			
1375	1233	31	3	2	3	29.5	2.5			
1400	1225	32	3	2	3	29.5	2.5			
1425	1217	32	3	2	3	29.4	2.4			
1450	1209	33	3	2	3	29.3	2.4			
1475	1201	33	3	2	3	29.2	2.3			
1500	1192	34	4	3	3	29.1	2.3			
1525	1184	34	4	3	3	29.0	2.2			
1550	1175	35	4	3	3	28.9	2.2			
1575	1167	35	4	3	3	28.8	2.1			
1600	1158	36	4	3	3	28.7	2.1			
1625	1149	37	4	3	3	28.6	2.0			
1650	1139	38	4	3	3	28.5	2.0			
1675	1130	38	4	3	3	28.4	2.0			
1700	1120	39	4	3	3	28.3	1.9			
1725	1110	40	4	3	3	28.2	1.9			
1750	1100	41	4	3	3	28.0	1.9			
1775	1090	43	4	3	3	27.9	1.8			
1800	1079	44	5	3	3	27.7	1.8			
1825	1068	46	5	4	3	27.6	1.7			
1850	1056	47	5	4	3	27.4	1.7			
1875	1044	49	5	4	3	27.2	1.7			
1900	1031	52	5	4	3	27.0	1.6			

CHARGE 2		TABLE D CORRECTION FACTORS												
FT 60-P-1 CTG, HE, N720 FUZE, NO, N734		8	9	10	11	12	13	14	15					
R A N G E	E L E V	RANGE CORRECTIONS FOR												
		MUZZLE VELOCITY 1 M/S			RANGE WIND 1 KNOT			AIR TEMP 1 PCT			AIR DENSITY 1 PCT			
		DEC	INC	HEAD	TAIL	DEC	INC	DEC	INC	DEC	INC			
N	M	N	N	N	N	M	M	N	N	N	N	N	N	
1100	10.2	-8.6	4.5	-3.5	0.0	0.0	0.0	-3.2	3.1					
1125	10.6	-8.9	4.5	-3.5	0.0	0.0	-3.2	3.2						
1150	10.8	-9.1	4.5	-3.6	0.0	0.0	-3.3	3.3						
1175	11.0	-9.3	4.5	-3.6	0.0	0.0	-3.4	3.3						
1200	11.3	-9.5	4.5	-3.6	0.0	0.0	-3.4	3.4						
1225	11.5	-9.7	4.5	-3.6	0.0	0.0	-3.5	3.5						
1250	11.8	-9.9	4.5	-3.6	0.0	0.0	-3.6	3.5						
1275	12.0	-10.1	4.5	-3.6	0.0	0.0	-3.6	3.6						
1300	12.3	-10.3	4.5	-3.6	0.0	0.0	-3.7	3.7						
1325	12.5	-10.5	4.6	-3.6	0.0	0.0	-3.8	3.7						
1350	12.7	-10.7	4.6	-3.6	0.0	0.0	-3.8	3.8						
1375	13.0	-10.9	4.6	-3.7	0.0	0.0	-3.9	3.8						
1400	13.2	-11.1	4.6	-3.7	0.0	0.0	-4.0	3.9						
1425	13.5	-11.3	4.6	-3.7	0.0	0.0	-4.0	4.0						
1450	13.7	-11.5	4.6	-3.7	0.0	0.0	-4.1	4.0						
1475	14.0	-11.7	4.6	-3.7	0.0	0.0	-4.1	4.1						
1500	14.2	-11.9	4.6	-3.7	0.0	0.0	-4.2	4.2						
1525	14.5	-12.1	4.6	-3.7	0.0	0.0	-4.3	4.2						
1550	14.7	-12.3	4.6	-3.8	0.0	0.0	-4.3	4.3						
1575	15.0	-12.5	4.6	-3.8	0.0	0.0	-4.4	4.3						
1600	15.2	-12.7	4.6	-3.8	0.0	0.0	-4.5	4.4						
1625	15.5	-12.9	4.6	-3.8	0.0	0.0	-4.5	4.5						
1650	15.7	-13.2	4.6	-3.8	0.0	0.0	-4.6	4.5						
1675	16.0	-13.4	4.6	-3.8	0.0	0.0	-4.6	4.6						
1700	16.2	-13.6	4.6	-3.8	0.0	0.0	-4.7	4.6						
1725	16.5	-13.8	4.6	-3.8	0.0	0.0	-4.8	4.7						
1750	16.7	-14.0	4.6	-3.9	0.0	0.0	-4.8	4.7						
1775	17.0	-14.2	4.6	-3.9	0.0	0.0	-4.9	4.8						
1800	17.2	-14.4	4.6	-3.9	0.0	0.0	-4.9	4.9						
1825	17.5	-14.6	4.6	-3.9	0.0	0.0	-5.0	4.9						
1850	17.7	-14.8	4.6	-3.9	0.0	0.0	-5.1	5.0						
1875	18.0	-15.0	4.6	-3.9	0.0	0.0	-5.1	5.0						
1900	18.3	-15.2	4.6	-3.9	0.0	0.0	-5.2	5.1						

Figure 4-6. Sample pages from firing tables for 60-mm mortar.

4-49. The following information describes the firing table for the 81-mm mortar. An example is shown in Figure 4-7.

NOTE: To round off range, look for the range at the lowest charge, then round it off to the closest range.

- Part I contains six parts, the first of which contains data for corrections for the HE M889 cartridge. The other five parts contain firing data for a given propelling charge using the HE M821 cartridge. Tables A, B, C, D, and E provide the same data for all mortar firing tables.
- Part II contains four parts and provides data for the M819 cartridge, red phosphorus. All four parts contain data for given propelling charges.
- The appendices contain trajectory charts. The computer uses these charts to determine the height of a round for a given charge and the nearest 100-mil elevation the round will travel to a given range. These charts assist computer in determining what round to use during urban combat.
- FT 81-AI-3 contains data similar to that of the FT 81-AR-2, but addresses M374A2 HE, M374 HE, M375A2 WP, M375 WP, M375A2 WP, and M301A3 illumination rounds. It also contains a section that gives the range, elevation, and maximum ordinate for the M68 training round.
- FT 81-AQ-1 contains data for M374A3 HE and M375A3 WP rounds similar to that contained in FT 81-AR-2.

TABLE D BASIC DATA							TABLE D CORRECTION FACTORS														
FT 81-AR-2 CTG. HE, M821 FUZE. NO. M734							FT 81-AR-2 CTG. HE, M821 FUZE. NO. M734														
CHARGE 2	1	2	3	4	5	6	7	1	3	5	10	11	12	13	14	15	CHARGE 2				
R N G E	E L E V	D E L E V P E R 100 M DR	A P P R O X N O. O F T U R N S P E R 100 M DR	L I N E N O.	T I M E O F F L I G H T	A Z I M U T C O R R E C T I O N C M O F 1 K N O T	RANGE CORRECTIONS FOR														
							H U Z Z L E V E L O C I T Y 1 M /S			R A N G E W I N D 1 K N O T		A I R T E M P 1 P C T		A I R D E N S I T Y 1 P C T							
	DEC	INC	HEAD	TAIL	DEC	INC	DEC	INC	DEC	INC	DEC	INC	DEC	INC	DEC	INC					
H	M	M	H	H	H	H	H	H	H	H	H	H	H	H	H	H					
1125	1422	16	2	5	39.6	4.0	1125	8.8	-7.8	4.4	-3.6	0.1	-0.1	-2.3	2.8		1125				
1150	1418	16	2	5	39.6	3.9	1150	5.0	-7.8	4.4	-3.7	0.1	-0.1	-2.9	2.9		1150				
1175	1414	16	2	5	39.6	3.8	1175	5.2	-8.0	4.4	-3.7	0.1	-0.1	-3.0	3.0		1175				
1200	1410	16	2	5	39.5	3.7	1200	5.4	-8.1	4.4	-3.7	0.1	-0.1	-3.0	3.0		1200				
1225	1406	16	2	5	39.5	3.6	1225	5.6	-8.3	4.5	-3.7	0.1	-0.1	-3.1	3.1		1225				
1250	1402	16	2	5	39.5	3.6	1250	5.8	-8.5	4.5	-3.7	0.1	-0.1	-3.2	3.1		1250				
1275	1398	16	2	4	39.4	3.5	1275	10.0	-8.8	4.5	-3.7	0.1	-0.1	-3.2	3.2		1275				
1300	1394	16	2	4	39.4	3.4	1300	10.2	-8.8	4.5	-3.7	0.1	-0.1	-3.3	3.3		1300				
1325	1390	16	2	4	39.3	3.3	1325	10.4	-9.0	4.5	-3.7	0.1	-0.1	-3.3	3.3		1325				
1350	1386	17	2	4	39.3	3.2	1350	10.6	-9.2	4.5	-3.7	0.1	-0.1	-3.4	3.4		1350				
1375	1381	17	2	4	39.2	3.2	1375	10.8	-9.3	4.5	-3.7	0.1	-0.1	-3.5	3.4		1375				
1400	1377	17	2	4	39.2	3.1	1400	11.0	-9.5	4.5	-3.7	0.1	-0.1	-3.5	3.5		1400				
1425	1373	17	2	4	39.1	3.0	1425	11.2	-9.7	4.6	-3.7	0.1	-0.1	-3.6	3.6		1425				
1450	1369	17	2	4	39.1	3.0	1450	11.4	-9.9	4.6	-3.7	0.1	-0.1	-3.6	3.6		1450				
1475	1365	17	2	4	39.0	2.9	1475	11.6	-10.0	4.6	-3.7	0.1	-0.1	-3.7	3.7		1475				
1500	1360	17	2	4	39.0	2.6	1500	11.8	-10.2	4.6	-3.7	0.1	-0.1	-3.8	3.7		1500				
1525	1356	17	2	4	38.9	2.8	1525	12.0	-10.4	4.6	-3.7	0.1	-0.1	-3.8	3.8		1525				
1550	1352	17	2	4	38.8	2.7	1550	12.2	-10.6	4.6	-3.7	0.1	-0.1	-3.9	3.8		1550				
1575	1348	17	2	4	38.8	2.7	1575	12.4	-10.7	4.6	-3.8	0.1	-0.1	-3.9	3.9		1575				
1600	1343	17	2	4	38.7	2.6	1600	12.6	-10.9	4.7	-3.8	0.2	-0.1	-4.0	4.0		1600				
1625	1339	17	2	4	38.7	2.6	1625	12.8	-11.1	4.7	-3.8	0.2	-0.1	-4.0	4.0		1625				
1650	1335	17	2	4	38.6	2.5	1650	13.0	-11.2	4.7	-3.8	0.2	-0.1	-4.1	4.1		1650				
1675	1330	17	2	4	38.5	2.5	1675	13.2	-11.4	4.7	-3.8	0.2	-0.1	-4.1	4.1		1675				
1700	1326	17	2	4	38.5	2.4	1700	13.4	-11.5	4.7	-3.8	0.2	-0.1	-4.2	4.2		1700				
1725	1322	18	2	4	38.4	2.4	1725	13.6	-11.8	4.7	-3.8	0.2	-0.1	-4.3	4.2		1725				
1750	1317	18	2	4	38.3	2.3	1750	13.8	-11.9	4.7	-3.8	0.2	-0.1	-4.3	4.3		1750				
1775	1313	18	2	4	38.3	2.3	1775	14.0	-12.1	4.7	-3.8	0.2	-0.1	-4.4	4.4		1775				
1800	1308	18	2	4	38.2	2.2	1800	14.2	-12.3	4.8	-3.8	0.2	-0.1	-4.5	4.4		1800				
1825	1304	18	2	4	38.1	2.2	1825	14.4	-12.5	4.8	-3.8	0.2	-0.1	-4.5	4.5		1825				
1850	1299	18	2	4	38.0	2.2	1850	14.6	-12.6	4.8	-3.9	0.2	-0.1	-4.6	4.5		1850				
1875	1295	18	2	4	38.0	2.1	1875	14.8	-12.8	4.8	-3.9	0.2	-0.1	-4.6	4.6		1875				
1900	1290	18	2	4	37.9	2.1	1900	15.0	-13.0	4.8	-3.9	0.2	-0.1	-4.7	4.6		1900				

Figure 4-7. Sample pages from firing tables for 81-mm mortar.

4-50. The following information describes the firing table for the 120-mm mortar. An example is shown in Figure 4-8.

- Parts I and II provide elevation information for use with 120-mm NDI ammunition.
- Parts I and II provide general data, ground data, and correction factors for each round. Part I includes M57 HE and M68 WP rounds. Part II includes the M91 illumination round.

TABLE D BASIC DATA							TABLE D CORRECTION FACTORS								
FT 120-A-0							FT 120-A-0								
CTG. NO. M934 FUZE. NO. M734							CTG. NO. M934 FUZE. NO. M734								
1	2	3	4	5	6	7	1	2	3	10	11	12	13	14	15
R A N G E	E L E V	D E L E V P E R 100 M DR	A P P R O X N O. O F T U R N S P E R 100 M DR	L I N E N O.	T I M E O F F L I G H T	A Z I M U T H C O R R E C T I O N C O O F O F 1 K M O T	RANGE CORRECTIONS FOR								
M		NIL		SEC		NIL		M		M		M		M	
N		N		N		N		N		N		N		N	
M		M		M		M		M		M		M		M	
1600	1410	13	3	5	41.5	2.1	1500	11.7	-10.3	3.8	+3.1	0.0	0.0	-3.0	3.0
1625	1407	13	3	5	41.8	2.0	1525	11.9	-10.4	3.8	+3.2	0.0	0.0	-3.0	3.0
1650	1403	13	3	5	41.8	2.0	1550	12.1	-10.6	3.8	+3.2	0.0	0.0	-3.1	3.1
1675	1400	13	3	5	41.8	1.9	1575	12.3	-10.8	3.8	+3.2	0.0	0.0	-3.1	3.1
1700	1397	13	3	5	41.7	1.9	1600	12.5	-11.0	3.8	+3.2	0.0	0.0	-3.2	3.2
1625	1393	13	3	5	41.7	1.9	1625	12.7	-11.1	3.8	+3.2	0.0	0.0	-3.2	3.2
1650	1390	13	3	5	41.7	1.9	1650	12.9	-11.3	3.8	+3.2	0.0	0.0	-3.3	3.3
1675	1387	13	3	5	41.7	1.8	1675	13.1	-11.5	3.8	+3.2	0.0	0.0	-3.3	3.3
1700	1383	13	3	5	41.6	1.8	1700	13.3	-11.6	3.8	+3.2	0.0	0.0	-3.4	3.4
1725	1380	13	3	5	41.6	1.8	1725	13.5	-11.8	3.8	+3.2	0.0	0.0	-3.4	3.4
1750	1377	13	3	5	41.6	1.7	1750	13.7	-12.0	3.8	+3.2	0.0	0.0	-3.5	3.4
1775	1373	14	3	5	41.6	1.7	1775	13.9	-12.2	3.8	+3.2	0.0	0.0	-3.5	3.5
1800	1370	14	3	5	41.5	1.7	1800	14.1	-12.3	3.8	+3.2	0.0	0.0	-3.5	3.5
1825	1367	14	3	5	41.5	1.7	1825	14.3	-12.5	3.8	+3.2	0.0	0.0	-3.6	3.6
1850	1363	14	3	5	41.5	1.6	1850	14.5	-12.7	3.8	+3.2	0.0	0.0	-3.7	3.6
1875	1360	14	3	5	41.5	1.6	1875	14.7	-12.9	3.8	+3.2	0.0	0.0	-3.7	3.7
1900	1356	14	3	5	41.4	1.6	1900	14.9	-13.0	4.0	+3.2	0.0	0.0	-3.7	3.7
1925	1353	14	3	5	41.4	1.6	1925	15.1	-13.2	4.0	+3.2	0.0	0.0	-3.8	3.8
1950	1349	14	3	5	41.4	1.6	1950	15.3	-13.4	4.0	+3.3	0.0	0.0	-3.8	3.8
1975	1346	14	3	5	41.3	1.5	1975	15.4	-13.6	4.0	+3.3	0.0	0.0	-3.9	3.9
2000	1342	14	3	5	41.3	1.5	2000	15.6	-13.7	4.0	+3.3	0.0	0.0	-3.9	3.9
2025	1339	14	3	5	41.3	1.5	2025	15.8	-13.9	4.0	+3.3	0.0	0.0	-4.0	4.0
2050	1335	14	3	5	41.2	1.5	2050	16.0	-14.1	4.0	+3.3	0.0	0.0	-4.0	4.0
2075	1332	14	3	5	41.2	1.5	2075	16.2	-14.2	4.0	+3.3	0.0	0.0	-4.1	4.1
2100	1328	14	3	5	41.2	1.4	2100	16.4	-14.4	4.0	+3.3	0.0	0.0	-4.1	4.1
2125	1325	14	3	5	41.1	1.4	2125	16.6	-14.6	4.1	+3.3	0.0	0.0	-4.2	4.1
2150	1321	14	3	5	41.1	1.4	2150	16.8	-14.8	4.1	+3.3	0.0	0.0	-4.2	4.2
2175	1318	14	3	5	41.1	1.4	2175	17.0	-14.9	4.1	+3.3	0.0	0.0	-4.3	4.2
2200	1314	14	3	5	41.0	1.4	2200	17.2	-15.1	4.1	+3.3	0.0	0.0	-4.3	4.3
2225	1310	15	3	5	41.0	1.3	2225	17.4	-15.3	4.1	+3.3	0.0	0.0	-4.4	4.3
2250	1307	15	3	5	40.9	1.3	2250	17.6	-15.5	4.1	+3.3	0.0	0.0	-4.4	4.4
2275	1303	15	3	5	40.9	1.3	2275	17.8	-15.6	4.1	+3.4	0.0	0.0	-4.5	4.4
2300	1299	15	3	5	40.9	1.3	2300	18.0	-15.8	4.1	+3.4	0.0	0.0	-4.5	4.5

Figure 4-8. Sample pages from firing tables for the 120-mm mortar.

DA FORM 3675-R (BALLISTIC MESSAGE)

4-51. DA Form 3675-R (Ballistic Message) and DA Form 3677-R (Computer MET Message) allow the user to determine necessary firing data corrections so that the section has better accuracy and target effect without re-registering every two to four hours.

USE OF METEOROLOGICAL MESSAGE

4-52. MET messages provide information about air temperature and density, and the speed and direction of the wind between the mortar platoon and the targets. The validity of a MET message increases over time. There are no specific rules for determining how long a MET message is usable, since that determination depends on the atmospheric conditions.

4-53. To be valid, the MET message must be received with the initial registration mission. To ensure that the first MET message will be current, the FDC requests a MET message shortly after setting up the surveyed firing chart. This message alone is not adequate to determine firing corrections, but it can tell the

FDC how many registration corrections are due to weather. After the FDC receives and computes the first MET message, they receive a second within four hours, compare the two, and determine the data used to update the firing equipment.

SOURCE OF METEOROLOGICAL MESSAGE

4-54. In the modular force, each BCT, whether heavy or light, will have one MET system in the fires battalion. Each fires brigade will have three MET systems; however, owing to a lack of assets, each fires brigade will initially be fielded with one MET system. The FA unit operations officer coordinates with the MET station leader and unit signal staff officers to prioritize the means of communicating and disseminating messages, and to assign radiosonde frequencies. If a ballistic MET message is necessary (such as when only the M16 plotting board is used), the MET message can be transmitted by any means, including a digital plain text message.

RECEIPT OF METEOROLOGICAL MESSAGE

4-55. The MET message has two parts: the introduction and the body. It is broadcasted in six-character groups, as shown in Figure 4-9. The examples of completed DA Forms 3675-R (Figure 4-10) and 3677-R (Figure 4-11) use the same six-character groups to show how they are entered on the form.

NOTE: See FM 3-09.15 for guidance concerning the use of the aforementioned forms.

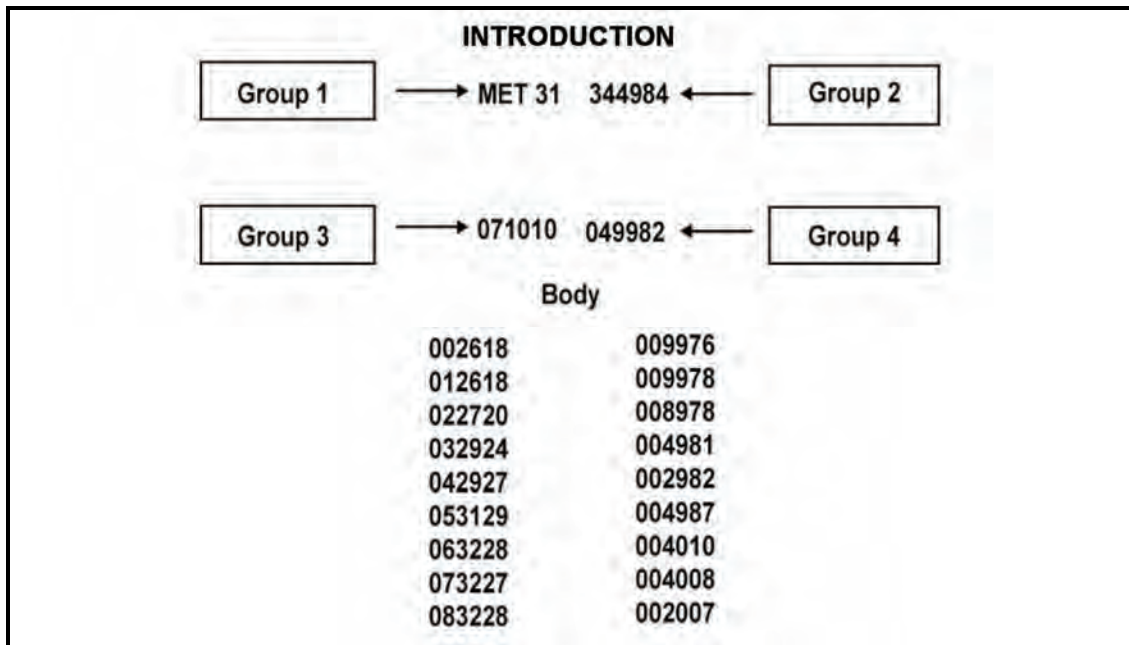

Figure 4-9. Six-character groups.

BALLISTIC MESSAGE									
For use of this form, see FM 3-09.15; the proponent agency is TRADOC.									
IDENTIFI- CATION	TYPE MSG	OCTANT	LOCATION		DATE	TIME (GMT)	DURATION (HOURS)	STATION HEIGHT (10s M)	MDP PRESSUR E
METB	K	Q	L _a L _a L _a or xxx	L _o L _o L _o or xxx	YY	G _o G _o G _o	G	hhh	% OF STD
METB	3	1	344	985	07	101	0	049	982
		BALLISTIC WINDS			BALLISTIC AIR				
ZONE HEIGHT (METERS)	LINE NUMBER ZZ	DIRECTION (100s MILS) dd		SPEED (KNOTS) FF	TEMPERATURE (% OF STD) TTT		DENSITY (% OF STD) ΔΔΔ		
SURFACE	00	26		18	009		976		
200	01	26		18	009		978		
500	02	27		20	008		978		
1000	03	29		24	004		981		
1500	04	29		27	002		982		
2000	05	31		29	004		987		
3000	06	32		28	004		010		
4000	07	32		27	004		008		
5000	08	32		28	002		007		
6000	09	31		28	001		005		
8000	10								
10000	11								
12000	12								
14000	13								
16000	14								
18000	15								
REMARKS									
DELIVERED TO:						TIME (GMT)		TIME (LST)	
RECEIVED FROM:									
MESSAGE NUMBER					DATE				
RECORDER					CHECKED				

DA FORM 3675-R, MAY 92

PREVIOUS EDITIONS ARE OBSOLETE.

APD V1.01

Figure 4-10. Example of completed DA Form 3675-R (Ballistic Message).

BALLISTIC MESSAGE									
For use of this form, see FM 3-09.15; the proponent agency is TRADOC.									
IDENTIFICATION	TYPE MSG	OCTANT	LOCATION		DATE	TIME (GMT)	DURATION (HOURS)	STATION HEIGHT (10s M)	MDP PRESSURE E % OF STD
METB	K	Q	l _a l _a l _a or xxx	L _o L _o L _o or xxx	YY	G _o G _o G _o	G	hhh	% OF STD
METB	3	1	356	321	08	1030	0	040	976
		BALLISTIC WINDS			BALLISTIC AIR				
ZONE HEIGHT (METERS)	LINE NUMBER ZZ	DIRECTION (100s MILS) dd		SPEED (KNOTS) FF	TEMPERATURE (% OF STD) TTT		DENSITY (% OF STD) ΔΔΔ		
SURFACE	00	19		19	000		976		
200	01	20		18	989		975		
500	02	21		20	000		999		
1000	03	20		20	001		002		
1500	04	18		19	997		982		
2000	05	20		21	001		983		
3000	06	17		18	987		987		
4000	07								
5000	08								
6000	09								
8000	10								
10000	11								
12000	12								
14000	13								
16000	14								
18000	15								
REMARKS									
DELIVERED TO:						TIME (GMT)	TIME (LST)		
RECEIVED FROM:									
MESSAGE NUMBER					DATE				
RECORDER					CHECKED				

DA FORM 3675-R, MAY 92

PREVIOUS EDITIONS ARE OBSOLETE.

APD V1.01

Figure 4-11. Example of completed DA Form 3675-R (Ballistic Message).

Introduction

4-56. The first four character groups in the MET message, the introduction, identify the type of message and the MET station transmitting the message. Table 4-22 identifies these character groups and explains their meanings.

Table 4-22. Character groups in the introduction and their corresponding meanings.

CHARACTER	MEANING
Group 1: MET B 31 (METCM) for computer MET	
MET	Indicates that the transmission is a MET message
B	Type of fire; indicates that the message is a ballistic MET message
3	Indicates that the message is for surface-to-surface fire NOTE: For use with mortars, the number 3 must appear.
1	Indicates the octant of the globe in which the MET message applies When code 9 is sent for the octant, the area is transmitted in code, not in numbers. Example: MIF MIF NOTE: Octants are further defined in the firing tables.
Group 2: 344985	
344	Indicates the latitude of the center of the area, expressed to the nearest tenth of a degree
985	Indicates the longitude of the center of the area, expressed to the nearest tenth of a degree
Group 3: 071010	
07	Indicates the day of the month
101	Indicates the hour the period of validity begins, expressed to the nearest tenth of an hour, Greenwich mean time (GMT) NOTE: To convert GMT to standard time, see FM 3-09.15.
0	Indicates the duration of the MET message NOTE: For US armed forces, the MET data is presumed valid until a later message is received.
Group 4: 049982	
049	Indicates the altitude of the MET station above sea level, expressed in tens of meters
982	Indicates the atmospheric pressure at the MET datum plane (MDP), expressed to the nearest one-tenth of a percent of standard atmospheric pressure at sea level NOTE: When this value is 100 or greater, the initial digit 1 is omitted.

Body

4-57. The next group of six-character blocks, the body, contains MET data listed by line number. Figure 4-12 depicts the relationship of the line numbers and zone heights to the meteorological datum plane. Table 4-23 identifies two of the character groups and explains their meanings. The remaining 16 lines contain the same information. Because of the height at which mortars can fire, not all 16 lines are applicable for mortars; only the first seven lines (00-006) need to be recorded (Figure 4-13).

Table 4-23. Character groups in the body and their corresponding meanings.

CHARACTER	MEANING
002618	
00	The line number indicating the standard height relative to the MDP
26	The direction from which the ballistic wind is blowing (measured clockwise from north, expressed in hundreds of mils) Example: This number represents 2600 mils.
18	The ballistic wind speed to the nearest knot Example: This number represents 18 knots.
009976	
009	The ballistic air temperature to the nearest 0.1 percent of standard NOTE: The initial digit 1 is omitted when the value is 100 or greater.
976	The ballistic air density to the nearest 0.1 percent of standard NOTE: As with temperature, the initial 1 is omitted when the value is 100 or greater.

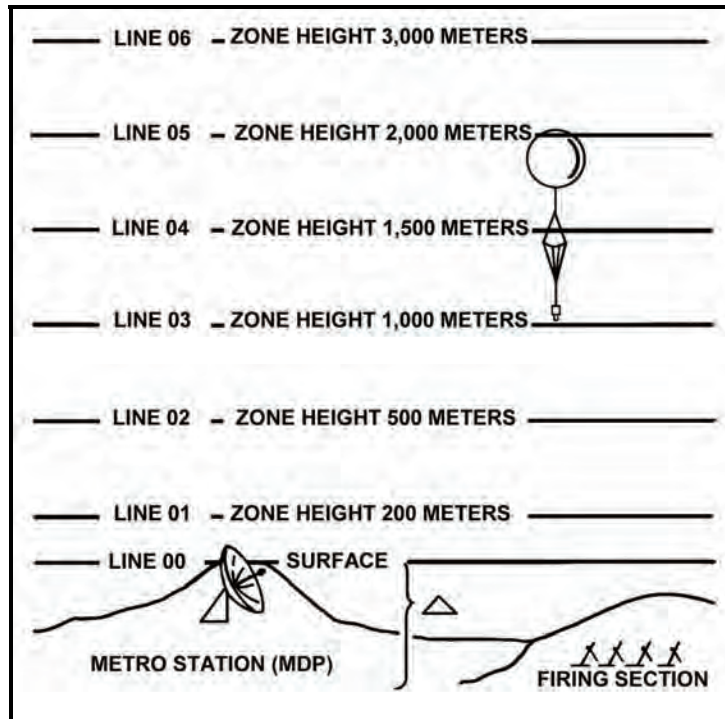

Figure 4-12. Line number and zone height relative to meteorological data plane.

BALLISTIC MESSAGE									
For use of this form, see FM 3-09.15; the proponent agency is TRADOC.									
IDENTIFI- CATION	TYPE MSG	OCTANT	LOCATION L _a L _a L _a L _o L _o L _o or xxx xxx		DATE YY	TIME (GMT) G ₀ G G ₀	DURATION (HOURS) G	STATION HEIGHT (10s M) hhh	MDP PRESSUR E % OF STD
METB	K	Q	356	321	08	1030	0	040	976
METB	3	1							
ZONE HEIGHT (METERS)	LINE NUMBER ZZ	BALLISTIC WINDS		BALLISTIC AIR					
		DIRECTION (100s MILS) dd	SPEED (KNOTS) FF	TEMPERATURE (% OF STD) TTT	DENSITY (% OF STD) ΔΔΔ				
SURFACE	00	19	19	000	976				
200	01	20	18	989	975				
500	02	21	20	000	999				
1000	03	20	20	001	002				
1500	04	18	19	997	982				
2000	05	20	21	001	983				
3000	06	17	18	987	987				
4000	07								
5000	08								
6000	09								
8000	10								
10000	11								
12000	12								
14000	13								
16000	14								
18000	15								
REMARKS									
DELIVERED TO: RECEIVED FROM:						TIME (GMT)	TIME (LST)		
MESSAGE NUMBER					DATE				
RECORDER					CHECKED				
DA FORM 3675-R, MAY 92 PREVIOUS EDITIONS ARE OBSOLETE. APD-V1.01									

Figure 4-13. Example of completed first seven lines for DA Form 3675-R (Ballistic Message).

RECORDING OF THE METEOROLOGICAL MESSAGE

4-58. As the battalion headquarters sends the MET message, the computer records it on DA Forms 3675-R and 3677-R. (See FM 3-09.15 for guidance on the use of these forms.) If the computer misses something or records the wrong information during the transmission, the format of the form allows him to ask for that portion of the message to be repeated.

METEOROLOGICAL MESSAGE COMPUTATION

4-59. After recording the MET message, the FDC uses DA Form 2601-1-R (MET Data Correction Sheet for Mortars) to compute the MET and determines the corrections that will be applied when updating the firing equipment (Figures 4-14 and 4-15). Personnel record known data in the proper spaces on the form. These data are available at the mortar platoon or section (obtained from DA Form 2188-R, DA Form 2188-1-R, or section sergeant).

NOTE: For a blank, reproducible copy of DA Form 2601-1-R, see the back of this publication.

4-60. Table 4-24 highlights the fields found in this form and provides more information about each area.

Table 4-24. DA Form 2601-1-R (MET Data Correction Sheet for Mortars) field titles and information documented in each field.

FIELD	INFORMATION DOCUMENTED IN FIELD
Charge	The command charge used to hit the RP NOTE: This charge is used to determine the line number to be used for computing the message.
Chart Range	The command range from the mortar platoon or section to the RP NOTE: Using the command charge and range puts the round at its highest ordinate for that range, where the round is affected most.
Elevation	The elevation used to hit the RP
Altitude of Mortars	The altitude of the mortar platoon or section to the nearest 10 meters
Line Number	The number in this field is used for the MET and can be recorded before the MET message is received. To do so, the computer enters the firing tables as follows: <ul style="list-style-type: none"> For 60-, 81-, or 120-mm mortars, find the command charge. Go to column 1 (range) and find the command range. Go to column 5. The number at that range in column 5 is the line number. Once the FDC has received and recorded the MET message, record the introduction and information from the line number being used. Since the altitude of the MDP is expressed in tens of meters and the wind direction is expressed in hundreds of mils, change them to read their actual values. Then, determine the MET values (the corrections for this MET).
Direction of Fire	The azimuth to the RP to the nearest 100 mils
Powder Temp	The temperature of the propellants NOTE: If the temperature of the powder cannot be determined, air temperature at the platoon or section can be used.

MET DATA CORRECTION SHEET FOR MORTARS						
For use of this form, see FM 3-22.91; the proponent agency is TRADOC.						
COMMAND DATA			MET MESSAGE			
CHARGE <small>Fired at RP Data Sheet</small>	CHART RANGE <small>To RP Plotting Equipment</small>	ELEVATION <small>DA 2188-R Data Sheet</small>	TYPE <small>MET Introduction (Figure 4-13)</small>	STATION <small>MET Introduction (Figure 4-13)</small>	DATE <small>MET Introduction (Figure 4-13)</small>	
ALT OF MORTARS (m)		<small>DA 2188-R Data Sheet</small>	TIME <small>MET Introduction (Figure 4-13)</small>	ALT MDP <small>MET Introduction (Figure 4-13)</small>	LINE NUMBER <small>Table D, Column 6 (Figure 4-13)</small>	
ALT OF MDP		<small>MET Introduction (Figure 4-13)</small>	WIND DIRECTION <small>MET Body (Figure 4-13)</small>	WIND VELOCITY <small>MET Body (Figure 4-13)</small>	AIR TEMP <small>MET Body (Figure 4-13)</small>	AIR DENSITY <small>MET Body (Figure 4-13)</small>
SECTION ABOVE + MDP Δ H BELOW -	+	<small>Subtract altitude of MDP from the altitude of the mortars.</small>	Δ H CORRECTIONS		Δ T + <small>Table B.</small>	Δ D + <small>Table B.</small>
			CORRECTED VALUES		<small>Sum of two boxes above.</small>	<small>Sum of two boxes above.</small>
WIND COMPONENTS AND DEFLECTION CORRECTION						
WHEN DIRECTION OF WIND IS LESS THAN DIRECTION OF FIRE ADD			6400			
DIRECTION OF WIND			←			
DIRECTION OF FIRE			<small>DA 2188-R Data Sheet Nearest 100</small>			
CHART DIR OF WIND						
<p>CROSS WIND $\frac{\text{VELOCITY}}{\text{VELOCITY}} \times \frac{L}{R} \text{ Table A} = \frac{L}{R} \text{ Nearest .1 KNOTS} \times \text{Table D, Column 9} = \frac{\text{Nearest mil}}{\text{CORR FACTOR}} \text{ DEFL CORR}$</p> <p>RANGE WIND $\frac{\text{VELOCITY}}{\text{VELOCITY}} \times \frac{T}{H} \text{ Table A} = \frac{T}{H} \text{ Nearest .1 KNOTS}$</p>						
MET RANGE CORRECTIONS						
	KNOWN VALUE	STANDARD VALUES	VARIATION FROM STANDARDS	UNIT CORRECTIONS	PLUS	MINUS
POWDER TEMP	ΔV -	0	D	<small>Table D Column 1 or 11</small>	Round the results to the nearest whole meter.	
RANGE WIND	T H	0	T H	<small>Table D Column 12 or 13</small>		
AIR TEMP		100	D	<small>Table D Column 14 or 15</small>		
AIR DENSITY		100	D	<small>Table D Column 16 or 17</small>		
WT OF PROJECTILE	□	2 □	D	<small>Table D Column 18 or 19</small>		
MET CORRECTION TO APPLY					TOTAL	
	DEFL	RANGE			<small>Sub-Total</small>	<small>Sub-Total</small>
LAST MESSAGE	L R	+ -				
THIS MESSAGE	L R	+ -				
CORR TO APPLY	L R	+ -				
					RANGE CORR	
					Total	

Figure 4-14. Data guide for DA Form 2601-1-R (MET Data Correction Sheet for Mortars).

MET DATA CORRECTION SHEET FOR MORTARS						
For use of this form, see FM 3-22.91; the proponent agency is TRADOC.						
COMMAND DATA			MET MESSAGE			
CHARGE 4	CHART RANGE 1811	ELEVATION 1178	TYPE 3	STATION 344983	DATE 12	
ALT OF MORTARS (m) 460		TIME 1430	ALT MDP 370	LINE NUMBER 3		
ALT OF MDP 370		WIND DIRECTION 2400	WIND VELOCITY 19	AIR TEMP 103.9	AIR DENSITY 97.4	
SECTION ABOVE + MDP Δ H BELOW -		⊕ 90 Δ H CORRECTIONS		Δ T + .2	Δ D + .9	
				CORRECTED VALUES		103.7
WIND COMPONENTS AND DEFLECTION CORRECTION						
WHEN DIRECTION OF WIND IS LESS THAN DIRECTION OF FIRE ADD			6400			
DIRECTION OF WIND			2400			
			8800			
DIRECTION OF FIRE			4800			
CHART DIR OF WIND			4000			
CROSS WIND $\frac{19}{\text{VELOCITY}} \times \frac{\text{Ⓚ} \text{ .71}}{\text{COMPONENT}} = \frac{\text{Ⓚ} \text{ 13.5}}{\text{LATERAL WIND}} \text{ KNOTS} \times \frac{1.4}{\text{CORR FACTOR}} = \frac{\text{Ⓚ} \text{ 19}}{\text{DEFL CORR}}$						
RANGE WIND $\frac{19}{\text{VELOCITY}} \times \frac{\text{Ⓚ} \text{ .71}}{\text{COMPONENT}} = \frac{\text{Ⓚ} \text{ 13.5}}{\text{RANGE WIND}} \text{ KNOTS}$						
MET RANGE CORRECTIONS						
	KNOWN VALUE	STANDARD VALUES	VARIATION FROM STANDARDS	UNIT CORRECTIONS	PLUS	MINUS
POWDER TEMP 77°F	ΔV + .3	0	D Ⓚ .3	-15.3		5
RANGE WIND	Ⓚ 13.5	0	H Ⓚ 13.5	-2.9		39
AIR TEMP	103.7	100	D Ⓚ 3.7	∅	∅	
AIR DENSITY	96.5	100	D Ⓚ 3.5	-3.7		13
WT OF PROJECTILE	<input type="checkbox"/>	2 <input type="checkbox"/>	D Ⓚ NA			
MET CORRECTION TO APPLY					TOTAL	57
	DEFL	RANGE				
LAST MESSAGE	L R	+ -				
THIS MESSAGE	Ⓚ 19	Ⓚ 57	RANGE CORR			
CORR TO APPLY	L R	+ -				
					TOTAL	57

Figure 4-15. Example of completed DA Form 2601-1-R (MET Data Correction Sheet for Mortars).

AIR TEMPERATURE AND AIR DENSITY CORRECTIONS

4-61. To determine the corrected values for air temperature and density—

- (1) The computer must determine the location of the platoon or section in relationship to the MDP (difference in H correction). To do so, he compares the altitude of the section and the MDP, and subtracts the smaller from the larger. The remainder is the height of the platoon or section above or below the MDP.

NOTE: If the altitude of the section is above the MDP, the sign is plus (+); if below, the sign is minus (-).

- (2) Once he has calculated the distance above or below the MDP, the computer can enter Table B (Figure 4-16), which shows the correction that must be applied to the ballistic AIR TEMP AIR DENSITY on the DA Form 2601-1-R (Figure 4-14). This correction compensates for the difference in altitude between the platoon or section and the MDP, and determines the corrections for AIR TEMP (difference in T) and AIR DENSITY (difference in D). Those corrections modify the AIR TEMP and AIR DENSITY determined at the MDP to determine values at the mortar platoon or section. Corrections for a difference in T and a difference in D are arranged in four double rows in the table.
- (3) The numbers 0, +100-, +200-, and +300- in the left column of the table represent a difference in H expressed in hundreds of meters. The numbers 0 and +10- through +90- across the top represent a difference in H in tens of meters. The corrections can be found where the proper hundreds row crosses the proper tens column. The numerical sign of the corrections is opposite of the difference in H sign.

EXAMPLE

Assume that the difference in H is -30, the corrected value for the difference in H is +0.1, and the difference in D is +0.3 (enter a 0 in hundreds column, go across to +30-column). Those corrections are entered on DA Form 2601-1-R, and the corrected values can then be determined and recorded in the proper spaces.

CHARGE 2		TABLE B TEMPERATURE AND DENSITY CORRECTIONS										FT 81-AR-2 CTG, HE, M821 FUZE, M0, M734	
CORRECTIONS TO TEMPERATURE (DT) AND DENSITY (DD), IN PERCENT, TO COMPENSATE FOR THE DIFFERENCE IN ALTITUDE, IN METERS, BETWEEN THE BATTERY AND THE MDP													
DH		0	+10-	+20-	+30-	+40-	+50-	+60-	+70-	+80-	+90-		
0	DT	0.0	0.0	0.0	-0.1+	-0.1+	-0.1+	-0.1+	-0.2+	-0.2+	-0.2+		
	DD	0.0	-0.1+	-0.2+	-0.3+	-0.4+	-0.5+	-0.6+	-0.7+	-0.8+	-0.9+		
+100-	DT	-0.2+	-0.2+	-0.2+	-0.3+	-0.3+	-0.3+	-0.3+	-0.4+	-0.4+	-0.4+		
	DD	-1.0+	-1.1+	-1.2+	-1.3+	-1.4+	-1.5+	-1.6+	-1.7+	-1.8+	-1.9+		
+200-	DT	-0.5+	-0.5+	-0.5+	-0.6+	-0.6+	-0.6+	-0.6+	-0.7+	-0.7+	-0.7+		
	DD	-2.0+	-2.1+	-2.2+	-2.3+	-2.4+	-2.5+	-2.6+	-2.7+	-2.8+	-2.9+		
+300-	DT	-0.7+	-0.7+	-0.7+	-0.8+	-0.8+	-0.8+	-0.8+	-0.9+	-0.9+	-0.9+		
	DD	-3.0+	-3.1+	-3.2+	-3.3+	-3.4+	-3.5+	-3.6+	-3.7+	-3.8+	-3.9+		

NOTES - 1. DH IS BATTERY HEIGHT ABOVE OR BELOW THE MDP.
2. IF ABOVE THE MDP, USE THE SIGN BEFORE THE NUMBER.
3. IF BELOW THE MDP, USE THE SIGN AFTER THE NUMBER.

Figure 4-16. Sample page from firing table for air temperature and density corrections.

WIND COMPONENT CORRECTIONS

4-62. To determine corrections for wind components—

- (1) The computer compares the direction of wind and the direction of fire (DOF). If the direction of wind is less than the DOF, it adds 6400 mils, and then subtracts the DOF.

EXAMPLE

DOF 4300

DIRECTION OF WIND (MET) 2900

$2900 + 6400 = 9300 - 4300 = 5000$ mils (chart direction of wind)

- (2) He then uses the remainder (CHART DIRECTION OF WIND) to enter Table A at the CHART DIRECTION OF WIND (Figure 4-17). Table A divides a 1-knot wind into crosswind and range wind components to show the effect on a round in flight. The chart direction of wind is the angle formed by the DOF and direction of wind.
- (3) The computer reads across that row to find the crosswind and range wind components, and records them in the proper spaces in DA Form 2601-1-R.
- (4) Once the wind components have been determined, the computer determines crosswind and range wind corrections.

FT 81-AR-2			TABLE A			CHARGE		
CTG. HE, M821			WIND COMPONENTS			2		
FUZE. HO, H734			WIND COMPONENTS					
COMPONENTS OF A ONE KNOT WIND								
CHART DIRECTION OF WIND	CROSS WIND	RANGE WIND	CHART DIRECTION OF WIND	CROSS WIND	RANGE WIND	CHART DIRECTION OF WIND	CROSS WIND	RANGE WIND
MIL	KNOT	KNOT	MIL	KNOT	KNOT	MIL	KNOT	KNOT
0	0	H1.00	3200	0	T1.00			
100	R.10	H.99	3300	L.10	T.99			
200	R.20	H.98	3400	L.20	T.98			
300	R.29	H.96	3500	L.29	T.96			
400	R.38	H.92	3600	L.38	T.92			
500	R.47	H.88	3700	L.47	T.88			
600	R.56	H.83	3800	L.56	T.83			
700	R.63	H.77	3900	L.63	T.77			
800	R.71	H.71	4000	L.71	T.71			
900	R.77	H.63	4100	L.77	T.63			
1000	R.83	H.56	4200	L.83	T.56			
1100	R.88	H.47	4300	L.88	T.47			
1200	R.92	H.38	4400	L.92	T.38			
1300	R.96	H.29	4500	L.96	T.29			
1400	R.98	H.20	4600	L.98	T.20			
1500	R.99	H.10	4700	L.99	T.10			
1600	R1.00	0	4800	L1.00	0			
1700	R.99	T.10	4900	L.99	H.10			
1800	R.98	T.20	5000	L.98	H.20			
1900	R.96	T.29	5100	L.96	H.29			
2000	R.92	T.38	5200	L.92	H.38			
2100	R.88	T.47	5300	L.88	H.47			
2200	R.83	T.56	5400	L.83	H.56			
2300	R.77	T.63	5500	L.77	H.63			
2400	R.71	T.71	5600	L.71	H.71			
2500	R.63	T.77	5700	L.63	H.77			
2600	R.56	T.83	5800	L.56	H.83			
2700	R.47	T.88	5900	L.47	H.88			
2800	R.38	T.92	6000	L.38	H.92			
2900	R.29	T.96	6100	L.29	H.96			
3000	R.20	T.98	6200	L.20	H.98			
3100	R.10	T.99	6300	L.10	H.99			
3200	0	T1.00	6400	0	H1.00			

Figure 4-17. Sample page from firing table for wind components.

Crosswind (Deflection Correction)

4-63. To determine the deflection correction—

- (1) The computer multiplies the wind speed (Table A) by the wind velocity (MET). This yields the lateral wind.
- (2) Once the lateral wind is determined, he enters Table D (Figure 4-18), goes to column 7 (60-mm/81-mm/120-mm mortars), and finds the correction factor.
- (3) He records the correction factor in the proper space, multiplies it by the lateral wind, carries the sign of the component (left/right), and determines the product to the nearest mil.
- (4) The product is the deflection correction for this MET. The computer records it in the proper space on DA Form 2601-1-R.

CHARGE 4		TABLE D BASIC DATA					FT 120-E-1 CTG. WP, XM929 FUZE, PD, M745	
1	2	3	4	5	6	7		
RANGE	ELEV	D ELEV PER 100 M DR	APPROX NO. OF TURNS PER 100 M DR	LINE NO.	TIME OF FLIGHT	AZIMUTH CORRECTION CW OF 1 KNOT		
M	MIL	MIL			SEC	MIL		
1200	1511	7	2	7	56.3	6.0		
1225	1509	7	2	7	56.3	5.9		
1250	1507	7	2	7	56.3	5.8		
1275	1505	7	2	7	56.3	5.7		
1300	1503	7	2	7	56.4	5.6		
1325	1501	7	2	7	56.4	5.4		
1350	1500	7	2	7	56.4	5.3		
1375	1498	7	2	7	56.4	5.2		
1400	1496	7	2	7	56.4	5.1		
1425	1494	7	2	7	56.4	5.0		
1450	1492	7	2	7	56.4	5.0		
1475	1490	7	2	7	56.4	4.9		
1500	1489	7	2	7	56.4	4.8		
1525	1487	7	2	7	56.4	4.7		
1550	1485	7	2	7	56.4	4.6		
1575	1483	7	2	7	56.4	4.5		
1600	1481	7	2	7	56.4	4.5		
1625	1479	7	2	7	56.4	4.4		
1650	1478	7	2	7	56.4	4.3		
1675	1476	7	2	7	56.4	4.3		
1700	1474	7	2	7	56.4	4.2		
1725	1472	7	2	7	56.4	4.1		
1750	1470	7	2	7	56.4	4.1		
1775	1468	7	2	7	56.4	4.0		
1800	1467	7	2	7	56.4	3.9		
1825	1465	7	2	7	56.4	3.9		
1850	1463	7	2	7	56.4	3.8		
1875	1461	7	2	7	56.4	3.8		
1900	1459	7	2	7	56.4	3.7		
1925	1457	7	2	7	56.4	3.7		
1950	1456	7	2	7	56.3	3.6		
1975	1454	7	2	7	56.3	3.6		
2000	1452	7	2	7	56.3	3.5		

FT 120-E-1		TABLE D CORRECTION FACTORS										CHARGE 4	
CTG. WP, XM929 FUZE, PD, M745		1	8	9	10	11	12	13	14	15			
RANGE	ELEV	RANGE CORRECTIONS FOR											
		MUZZLE VELOCITY 1 M/S		RANGE WIND 1 KNOT		AIR TEMP 1 PCT		AIR DENSITY 1 PCT					
		DEC	INC	HEAD	TAIL	DEC	INC	DEC	INC				
M	M	M	M	M	M	M	M	M	M				
1200	4.9				7.7			2.7				4.1	
1225	5.0				7.7			2.8	-0.8			4.2	
1250	5.1	-4.0			7.7			2.9	-0.9			4.2	
1275	5.2	-4.1			7.7			2.9	-0.9			4.3	
1300	5.3	-4.2			7.7			3.0	-0.9			4.4	
1325	5.4	-4.2			7.7			3.0	-0.9			4.5	
1350	5.5	-4.3			7.7			3.1	-0.9			4.6	
1375	5.6	-4.4			7.8			3.1	-1.0			4.6	
1400	5.7	-4.5			7.8			3.2	-1.0			4.7	
1425	5.8	-4.6			7.8			3.3	-1.0			4.8	
1450	6.0	-4.7			7.8			3.3	-1.0			4.9	
1475	6.1	-4.7			7.8			3.4	-1.0			5.0	
1500	6.2	-4.8			7.8			3.4	-1.0			5.0	
1525	6.3	-4.9			7.8			3.5	-1.1			5.1	
1550	6.4	-5.0			7.8			3.5	-1.1			5.2	
1575	6.5	-5.1			7.8			3.6	-1.1			5.3	
1600	6.6	-5.2			7.9			3.7	-1.1			5.4	
1625	6.7	-5.2			7.9			3.7	-1.1			5.4	
1650	6.8	-5.3			7.9			3.8	-1.1			5.5	
1675	6.9	-5.4			7.9			3.8	-1.2			5.6	
1700	7.0	-5.5			7.9			3.9	-1.2			5.7	
1725	7.1	-5.6			7.9			3.9	-1.2			5.8	
1750	7.2	-5.7			7.9			4.0	-1.2			5.8	
1775	7.3	-5.8			7.9			4.0	-1.2			5.9	
1800	7.4	-5.8			8.0			4.1	-1.2			6.0	
1825	7.5	-5.9			8.0			4.2	-1.3			6.1	
1850	7.7	-6.0			8.0			4.2	-1.3			6.1	
1875	7.8	-6.1			8.0			4.3	-1.3			6.2	
1900	7.9	-6.2			8.0			4.3	-1.3			6.3	
1925	8.0	-6.3			8.0			4.4	-1.3			6.4	
1950	8.1	-6.3			8.0			4.4	-1.3			6.5	
1975	8.2	-6.4			8.1			4.5	-1.4			6.5	
2000	8.3	-6.5			8.1			4.5	-1.4			6.6	

Figure 4-18. Sample pages from firing table for basic data and correction factors.

Range Wind

4-64. To determine the range wind, the computer—

- (1) Multiplies the component by the wind speed.
- (2) Carries the sign of the component (H or T from Table D).
- (3) Determines to the nearest 0.1 mil.
- (4) Records it in the proper space on DA Form 2601-1-R.

Range Corrections

4-65. All values should be recorded in the proper spaces except DV, which is found as follows:

- (1) The computer enters Table C, which shows the corrections to the muzzle velocity for various temperatures of the propellant charges (Figure 4-19).
- (2) He finds the temperature closest to that recorded for the propellant; DV appears in the center column on the same line as the temperature.
- (3) The computer records that value in the proper space.
- (4) Then, he determines the amount by which all known values vary from the standard values upon which the firing tables are based.

NOTE: Within the firing tables, D means decrease from standard, and I means increase from standard.

- (5) Once those variations are determined, the computer enters Table D (Command Charge and Range, 60-mm/81-mm/120-mm mortar, Figure 4-18) goes to columns 8 to 15 (60-mm, 81-mm, and 120-mm), and records the unit corrections for each variation.

NOTE: The sign of the unit correction must be recorded; numbers without a sign are a plus (+). If the column ends, the last listed numbers are considered to continue.

FT 81-AR-2		TABLE C		CHARGE
CTG. HE, M889		PROPELLANT TEMPERATURE		2
FUZE, PD, M935		VARIATIONS IN MUZZLE VELOCITY DUE TO PROPELLANT TEMPERATURE		
TEMPERATURE OF PROPELLANT	VARIATION IN VELOCITY	TEMPERATURE OF PROPELLANT		
DEGREES F	M/S	DEGREES C		
-40	-4.3	-40.0		
-35	-4.8	-37.2		
-30	-5.6	-34.4		
-25	-6.4	-31.7		
-20	-7.2	-28.9		
-15	-8.0	-26.1		
-10	-8.8	-23.3		
-5	-9.6	-20.6		
0	-10.4	-17.8		
5	-11.2	-15.0		
10	-12.0	-12.2		
15	-12.7	-9.4		
20	-13.5	-6.7		
25	-14.3	-3.9		
30	-15.0	-1.1		
35	-15.8	1.7		
40	-16.5	4.4		
45	-17.3	7.2		
50	-18.0	10.0		
55	-18.8	12.8		
60	-19.5	15.6		
65	-20.3	18.3		
70	-21.0	21.1		
75	-21.8	23.9		
80	-22.5	26.7		
85	-23.3	29.4		
90	-24.0	32.2		
95	-24.8	35.0		
100	-25.5	37.8		
105	-26.3	40.6		
110	-27.0	43.3		
115	-27.8	46.1		
120	-28.5	48.9		
125	-29.3	51.7		
130	-30.0	54.4		

Figure 4-19. Sample page from firing table for propellant temperature.

- (6) Once the variations have been recorded, the computer multiplies the variations from standard by the unit corrections and places the result (rounded to the nearest whole meter) in the column with the same sign as the unit correction.
- (7) Once all corrections have been multiplied, the computer compares the minus (-) and plus (+), subtracts the smaller from the larger, and uses the sign of the larger. He determines the result to the nearest meter for 60-mm/ 81-mm/120-mm mortars and records it in the proper space.

COMPUTER METEOROLOGICAL MESSAGE

4-66. Instead of the ballistic MET that FDC personnel use when manually plotting with the M16 plotting board, the M23 MBC, M95/96 MFCS, and the LHMBC, along with artillery, use computerized MET (CMET). The following example highlights CMET with the M23 MBC.

NOTE: See Chapter 15 for the MFCS CMET and Chapter 17 for the LHMBC CMET.

4-67. When no MET is available, the computer uses the standard MET that is stored within itself. The MET menu has two main options: new and current. When a new MET message is received, it is entered into the computer using the new option in the MET menu. Once the update * option is selected, the new MET becomes the current MET and is applied to the firing data.

EXAMPLE

METEOROLOGICAL: NEW
 QUADRANT: 0
 LATITUDE: 322
 LONGITUDE: 845
 DATE: DAY: 02
 TIME: 100
 DURATION: 0
 STATION HEIGHT: 014
 ATMOSPHERIC PRESSURE: 003

00	231	002	2957	1003
01	200	008	2937	0902
02	230	013	3013	0064
03	185	009	2980	0921
04	000	000	2940	0868
05	074	013	2935	0820
06	057	023	2931	0074
07	067	027	2897	0730
08	070	029	2861	0688

4-68. To input new MET data—

- (1) Press the MET switch. “MET: NEW CURRENT” displays. Using multiple choice entry, select NEW.
- (2) Press the SEQ switch. Using numeric entry, enter the quadrant— 0.
- (3) Press the SEQ switch. Using numeric entry, enter the latitude and longitude— 322 and 845.
- (4) Press the SEQ switch. Using numeric entry, enter the day of the month and time of the MET message (CMT)—02 and 100.
- (5) Press the SEQ switch. Using numeric entry, enter the duration, station altitude, and atmospheric pressure—0, 014, and 003.

- (6) Press the SEQ switch. Using numeric entry, enter wind direction and speed for line 00— 231 and 002.
- (7) Press the SEQ switch. Using numeric entry, enter the temperature and air pressure for line 00— 2957 and 1003.
- (8) Using the procedures above, repeat steps (6) and (7) to line 9.
- (9) Press the SEQ switch. After line 8, UPDATE MET * is displayed. Using the multiple choice entry, select the flashing asterisk (*) to update the NEW MET stored in the MBC, placing the NEW MET in the CURRENT MET file, while retaining a copy in the NEW file. Sequence to ready.

NOTE: The MBC, M23, calculates the effect of the MET on the round when determining firing data. Only new MET files may be changed, and then they must be updated to the current file.

- (10) To check MET, enter the MET switch, select CURR, and review the MET message.
- (11) If a change is needed, enter NEW, make the necessary corrections, and select UPDATE MET *.

6400-MIL METEOROLOGICAL MESSAGE

4-69. The target area is usually larger than the transfer limits of the RP, and yet time, ammunition, and the tactical situation will permit firing only one registration.

4-70. By assuming negligible error in surveys or maps, lay of the weapons, and preparation of the plotting boards or MBC computer, the FDC can divide registration corrections for the RP into two corrections. The first is a function of the range fired; it is constant for a given range, regardless of direction. The second is a function of the direction fired.

4-71. If the amount of concurrent MET computed for the RP is subtracted from the total registration correction, the result is an absolute registration correction that does not change with the direction fired or the weather. The FDC can then plot an imaginary RP at the same range as the original RP, but in other directions (800 mils apart), compute a MET correction for each of those directions, and, by adding the different MET corrections to the absolute registration correction, determine different firing corrections for each of the imaginary RPs. The firing corrections determined for the imaginary RPs can be applied when engaging targets within their transfer limits.

COMPUTATION OF METEOROLOGICAL CORRECTIONS FOR LARGE SECTOR CAPABILITY

4-72. A special worksheet, such as DA Form 2601-2-R (MET Data Correction Sheet 6400 Mils [Mortars]) (Figures 4-20 and 4-21), is needed to compute multiple MET corrections from a single registration. The supplemental (imaginary) RPs are spaced 800 mils apart, extending to the right and left of the RP as far as needed to cover the sector of responsibility. DA Form 2601-2-R shows a full 6400-mil capacity. On the firing chart, imaginary RPs are plotted at the same range from the mortar position as the real RP. Following is the process that the FDC uses to compute MET corrections.

NOTE: For a blank, reproducible copy of DA Form 2601-2-R, see the back of this manual.

MET DATA CORRECTION SHEET 6400 MILS (MORTARS)										
FIRING DATA					MET MESSAGE					
CHARGE 4	CHART RANGE 1811	ELEVATION 1178	TYPE 3	STATION 344983	DATE 12	TIME				
ALTITUDE OF MORTARS (M)		460	ALT MDP 370	LINE NUMBER 3	WIND DIRECTION 2400					
ALTITUDE OF MDP		370	WIND VELOCITY 19	AIR TEMP 103.9	AIR DENSITY 97.4					
SECTION	ABOVE + MDP Δ H	⊖ 90	Δ H CORRECTIONS	Δ T ⊖ .2	Δ D ⊖ .9					
BELOW - MDP Δ H			CORRECTED VALUES	103.7	96.5					
WIND COMPONENTS										
WHEN DIRECTION OF WIND IS LESS THAN DIRECTION OF FIRE ADD		6400								
DIRECTION OF WIND		2400								
TOTAL		8800								
DIRECTION OF FIRE		4800								
CHART DIRECTION OF WIND (6400 IS LESS THAN CORRESPONDING DIRECTIONAL VARIATION TO CHECK POINTS)		4000								
DIRECTIONAL VARIATION TO CHECK POINTS		⊕	0800	1600	2400	3200	4000	4800	5600	
CHART WIND TO CHECK POINTS		4000	3200	2400	1600	0800	⊕	5600	4800	
DEFLECTION CORRECTIONS										
WIND VELOCITY (KNOTS)		19	19	19	19	19	19	19	19	
CROSS WIND COMPONENT		⊕ .71	⊖	⊕ .71	⊖	⊕ .71	⊖	⊕ .71	⊖	
CROSS WIND		⊕ 13.5	⊖	⊕ 13.5	⊖	⊕ 13.5	⊖	⊕ 13.5	⊖	
CROSS WIND CORRECTION FACTOR		1.4	1.4	1.4						
DEFLECTION CORRECTION		⊕ 19	⊖	⊕ 19	⊖ 27	⊕ 19	⊖	⊕ 19	⊖ 27	
RANGE CORRECTIONS										
WIND VELOCITY (KNOTS)		19	19	19	19	19	19	19	19	
RANGE WIND COMPONENT		⊕ .71	⊕ 1	⊕ .71	⊖	⊕ .71	⊕ 1	⊕ .71	⊖	
RANGE WIND		⊕ 13.5	⊕ 19	⊕ 13.5	⊖	⊕ 13.5	⊕ 19	⊕ 13.5	⊖	
RANGE WIND UNIT CORRECTION		-2.9	-2.9	-2.9	⊖	3.8	3.8	3.8	⊖	
RANGE WIND CORRECTION		⊖ 39	⊖ 55	⊖ 39	⊖	⊕ 51	⊕ 72	⊕ 51	⊖	
KNOWN VALUE		STANDARD VALUES		VARIATION FROM STANDARD		UNIT	PLUS	MINUS		
POWDER TEMP 77°F	AV - .3	⊖		⊖ .3		-15.3		5		
AIR TEMP	103.7	100		⊕ 3.7		-0-	-0-			
AIR DENSITY	96.5	100		⊕ 3.5		-37		13		
PROJECTILE WT		NOT COMPUTED FOR 81MM MORTARS								
ABSOLUTE REGISTRATION CORRECTIONS										
REGISTRATION CORRECTION		⊕ 125	⊖ 11							18
RP MET CORRECTION		⊖ 60	⊖ 19	BALLISTIC RANGE CORR.						-18
ABSOLUTE REG. CORRECTION		⊕ 65	⊖ 30							
DIRECTIONAL CORRECTIONS										
BALLISTIC RANGE CORR.		⊖ 18	⊖ 18	⊖ 18	⊖ 18	⊖ 18	⊖ 18	⊖ 18	⊖ 18	
RANGE WIND CORRECTION		⊖ 39	⊖ 55	⊖ 39	⊖	⊕ 51	⊕ 72	⊕ 51	⊖	
TOTAL RANGE CORRECTION		⊖ 60	⊖ 70	⊖ 60	⊖ 20	⊕ 30	⊕ 50	⊕ 30	⊖ 20	
MET CORRECTION		⊖ 60	⊖ 19	⊖ 60	⊖ 19	⊖ 20	⊖ 19	⊖ 50	⊖ 19	
ABSOLUTE REG. CORRECTION		⊕ 65	⊖ 30	⊕ 65	⊖ 30	⊕ 65	⊖ 30	⊕ 65	⊖ 30	
CORRECTIONS TO APPLY		⊕ 5	⊖ 39	⊕ 5	⊖ 11	⊕ 45	⊖ 30	⊕ 95	⊖ 49	

DA Form 2601-2-R, SEP 2008 APD FE VI 00

Figure 4-20. Example of completed DA Form 2601-2-R (MET Data Correction Sheet 6400 mils [Mortars]).

MET DATA CORRECTION SHEET 6400 MILS (MORTARS)									
HIRING DATA					MET MESSAGE				
CHARGE 174g	CHART RANGE 2910	ELEVATION 900	TYPE 53	STATION 344985	DATE 07	TIME			
ALTITUDE OF MORTARS (M) 4-60		ALT. MDP 490	LINE NUMBER 03	WIND DIRECTION 2900					
ALTITUDE OF MDP		WIND VELOCITY 24	AIR TEMP 100.4	AIR DENSITY 98.1					
SECTION	ABOVE + MDP Δ H	Δ H CORRECTIONS	Δ T	Δ D	CORRECTED VALUES				
BELOW	30		.1	3	100.5 98.4				
WIND COMPONENTS									
WHEN DIRECTION OF WIND IS LESS THAN DIRECTION OF FIRE ADD	6400								
DIRECTION OF WIND	2900								
TOTAL	9300	(RP)							
DIRECTION OF FIRE	-4300	I	II	III	IV	V	VI	VII	VIII
CHART DIRECTION OF WIND (6400 IS LESS THAN CORRESPONDING DIRECTIONAL VARIATION TO CHECK POINTS)	5000	5000	5000	5000	5000	5000	5000	5000	5000
DIRECTIONAL VARIATION TO CHECK POINTS	-0	-800	-1600	-2400	-3200	-4000	-4800	-5600	-6400
CHART WIND TO CHECK POINTS	5000	4200	3400	2600	1800	1000	200	5800	
DEFLECTION CORRECTIONS									
WIND VELOCITY (KNOTS)	24	24	24	24	24	24	24	24	24
CROSS WIND COMPONENT	0.98	0.83	0.20	0.56	0.99	0.83	0.20	0.56	0.98
CROSS WIND	0.235	0.199	0.48	0.134	0.235	0.199	0.48	0.134	0.235
CROSS WIND CORRECTION FACTOR	.9	.9	.9	.9	.9	.9	.9	.9	.9
DEFLECTION CORRECTION	0.21	0.18	0.44	0.12	0.21	0.18	0.44	0.12	0.21
RANGE CORRECTIONS									
WIND VELOCITY (KNOTS)	24	24	24	24	24	24	24	24	24
RANGE WIND COMPONENT	0.20	0.98	0.83	0.20	0.56	0.98	0.83	0.20	0.98
RANGE WIND	0.48	0.134	0.235	0.199	0.48	0.134	0.235	0.199	0.48
RANGE WIND UNIT CORRECTION	5.1	-3.7	-3.7	-3.7	-3.7	5.1	5.1	5.1	5.1
RANGE WIND CORRECTION	0.24	0.50	0.77	0.74	0.18	0.68	0.120	0.101	
	KNOWN VALUE	STANDARD VALUES	VARIATION FROM STANDARD		UNIT	PLUS	MINUS		
POWDER TEMP 60°F	$\Delta V = -0.5$	0	0.5	23.9	12				
AIR TEMP	100.5	100	0.5	0					
AIR DENSITY	98.4	100	1.6	-6.7					11
PROJECTILE WT	3	2	1	11	11				
ABSOLUTE REGISTRATION CORRECTIONS						23	11		
REGISTRATION CORRECTION	0.60	0.23					11		
RP MET CORRECTION	0.40	0.21					12		
ABSOLUTE REG. CORRECTION	0.20	0.2							
DIRECTIONAL CORRECTIONS									
BALLISTIC RANGE CORR.	0.12	0.12	0.12	0.12	0.12	0.12	0.12	0.12	0.12
RANGE WIND CORRECTION	0.24	0.50	0.77	0.74	0.18	0.68	0.120	0.101	
TOTAL RANGE CORRECTION	0.40	0.40	0.70	0.60	0.10	0.80	0.130	0.110	
MET CORRECTION	0.40	0.18	0.70	0.10	0.12	0.80	0.18	0.130	0.12
ABSOLUTE REG. CORRECTION	0.20	0.2	0.2	0.20	0.2	0.20	0.2	0.20	0.2
CORRECTIONS TO APPLY	0.60	0.23	0.20	0.50	0.6	0.40	0.10	0.19	0.100

Figure 4-21. Example of completed DA Form 2601-2-R (MET Data Correction Sheet 6400 mils [Mortars]) for a full 6400-mil capacity.

- (1) Complete the top section of the sheet, and compute the difference in H corrections and the corrected values for AIR TEMP and AIR DENSITY.
- (2) Determine the CHART DIRECTION OF WIND. Record the result in the box marked I (RP), and copy the result in as many boxes as there are imaginary RPs (II is 800 mils clockwise from the RP, and the numbers increase in a clockwise direction to VIII, which is 800 mils counterclockwise from the RP).
- (3) Add the directional variations to the CHART DIRECTION OF WIND, subtracting 6400 if the result is more than 6400.
- (4) Copy the wind velocity into the first row of boxes under DEFLECTION CORRECTIONS and RANGE CORRECTIONS. Do not use any column that does not have the CHART DIRECTION OF WIND written on top.
- (5) From Table A (Figure 4-17), extract the appropriate crosswind (record it in the DEFLECTION CORRECTIONS section) and range wind (record it in the RANGE CORRECTIONS section) components for each value of CHART WIND TO CHECKPOINTS.
- (6) Multiply the velocity by the components to get values for crosswind and range wind.
- (7) Find the crosswind correction factor corresponding to the adjusted RP charge in Table D, (column 7, 60-mm/81-mm/ 120-mm mortars). Multiply it by the crosswind to get the MET DEFLECTION CORRECTION.
- (8) Find the proper range wind unit correction in Table D, (columns 10 and 11, 60-mm/81-mm mortars). Multiply it by the range wind to get the RANGE WIND CORRECTION.
- (9) Compute the MET RANGE CORRECTIONS for POWDER TEMP, AIR TEMP, AIR DENSITY, and PROJECTILE WT in the usual manner. The net of the four is the ballistic range correction.
- (10) Combine the ballistic range correction with the various range wind corrections to obtain the total range corrections.
- (11) Obtain the total MET corrections by bringing together the MET RANGE CORRECTION and the MET DEFLECTION CORRECTION for each of the points.
- (12) Determine the absolute registration correction. First, calculate the registration correction. The registration range correction is the difference between the chart range to the RP and the range corresponding to the initial range at the RP; it is plus if the chart range is smaller. The DEFLECTION CORRECTION is the LARS (left, add; right, subtract) correction, which must be applied to the initial deflection read at the RP to get the firing deflection that hit it. The RP MET correction, which has been recorded under I (RP), is then subtracted from the registration correction; the result is the absolute registration correction.
- (13) Add the absolute registration correction to each point MET correction to obtain the corrections to apply at the points.

METEOROLOGICAL CORRECTIONS

4-73. To place fire on a target without adjustment, the FDC must know the target's exact location and must be able to compensate for all nonstandard conditions. Registration and re-registration are the most accurate methods of determining and maintaining firing corrections, but re-registration is not always practical. Between registrations, the MET message helps to determine corrections due to changes in conditions that affect the flight of rounds. Those conditions include changes in powder temperature, air temperature, air density, and the speed and direction of the wind. The FDC assumes that all other factors remain relatively constant until the section displaces.

4-74. Corrections computed from MET messages are not adequate firing corrections alone, but the use of MET corrections can eliminate the need for re-registration. To be of value to the FDC, a valid MET message must be received with or within four hours of the registration. Computing this MET message with the registration tells the FDC how much of the total registration correction is due to weather. By comparing the corrections from a later MET message, the FDC can modify the registration corrections to account for changes in weather.

4-75. For MET corrections to be of use, the FDC must receive two MET messages. The corrections from the two are compared to determine the current corrections to update the firing corrections determined from the registration. Once the two messages are computed, the correcting areas (deflection correction and range correction) are compared, and the product is used to update the registration corrections.

EXAMPLE

Assume that:

MET 1: Deflection correction L20 (Figure 4-22)

Range correction -100

Place the correction from the MET message on a MET cross.

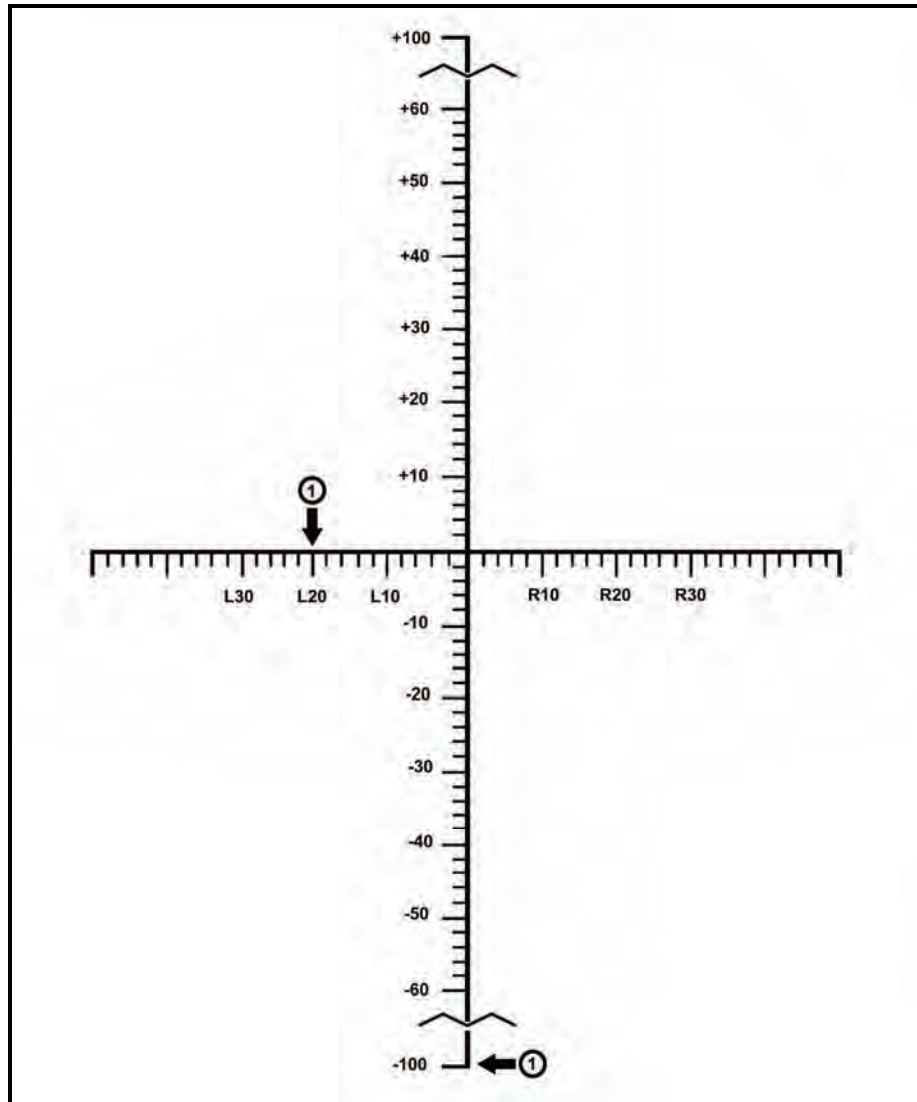

Figure 4-22. Initial meteorological message.

EXAMPLE

Assume that:

MET 2: Deflection correction R10 (Figure 4-23)
Range correction +25

Place the correction from the MET message on a MET cross.

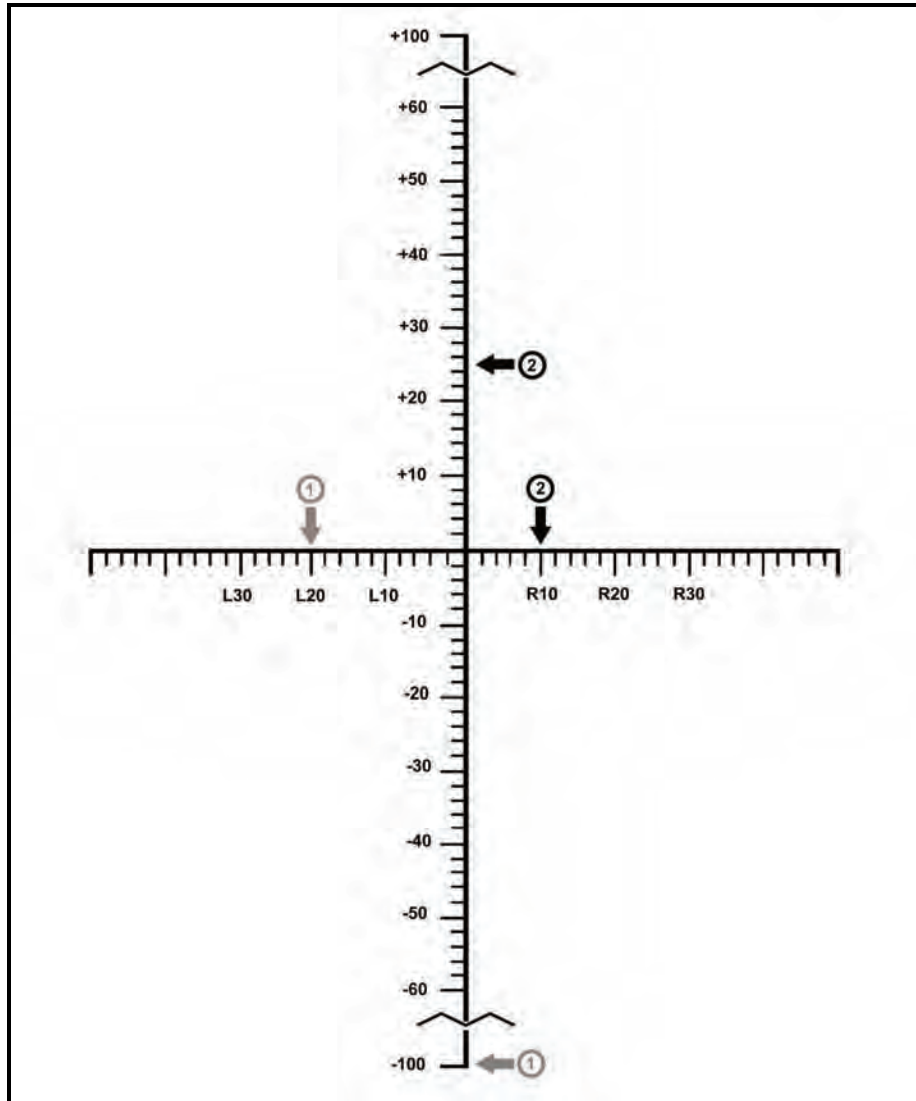

Figure 4-23. Second meteorological message.

4-76. The MET cross helps answer three key questions:

- Where are you? L20 - 100 (MET 1)
- Where are you going? R10 + 25 (MET 2)
- What is required to get there?

DEFLECTION CORRECTION

4-77. To get from L20 to R10, first go from L20 to 0, then right to R10. In doing so, you went R20, then R10, for a total of R30 (Figure 4-24).

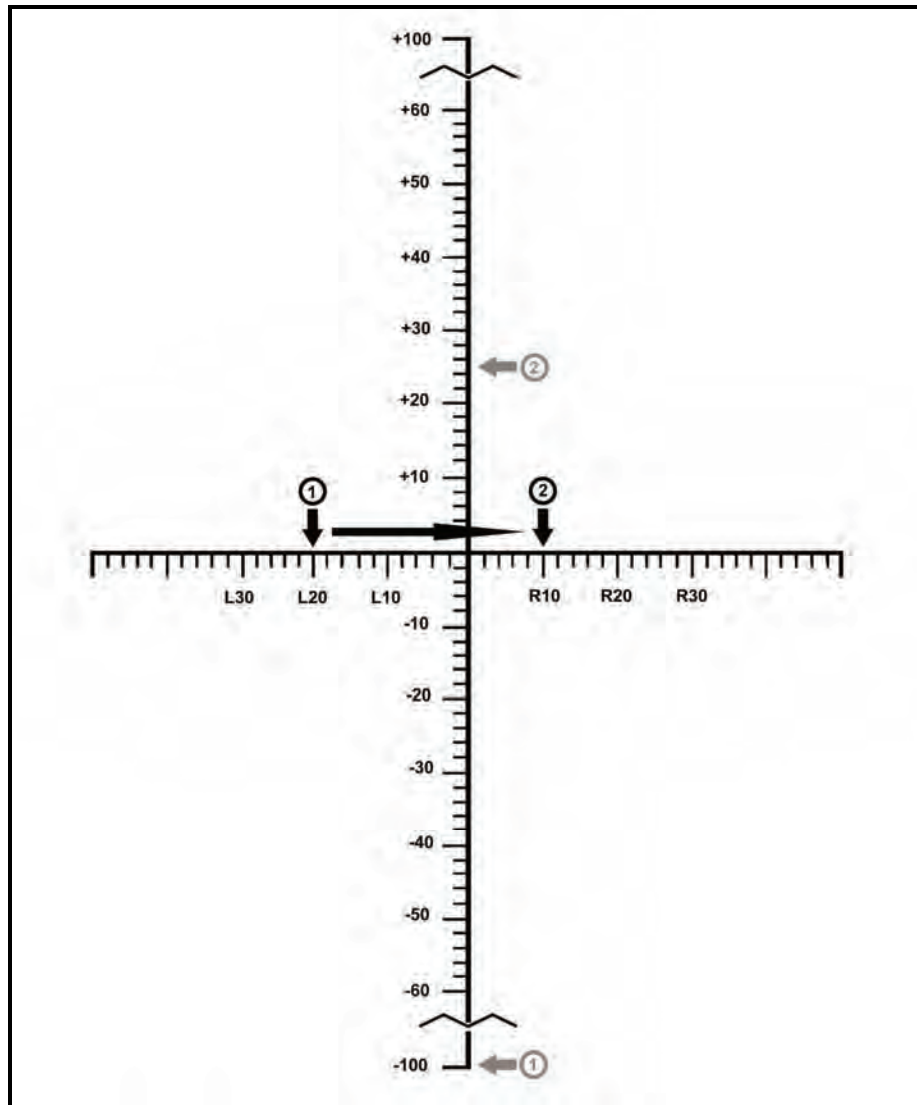

Figure 4-24. Updated registration corrections, deflection.

RANGE CORRECTION

4-78. To get from -100 to +25, first go from -100 to 0, then up the scale to +25. In doing so, you went +100, then +25, for a total correction of +125 (Figure 4-25).

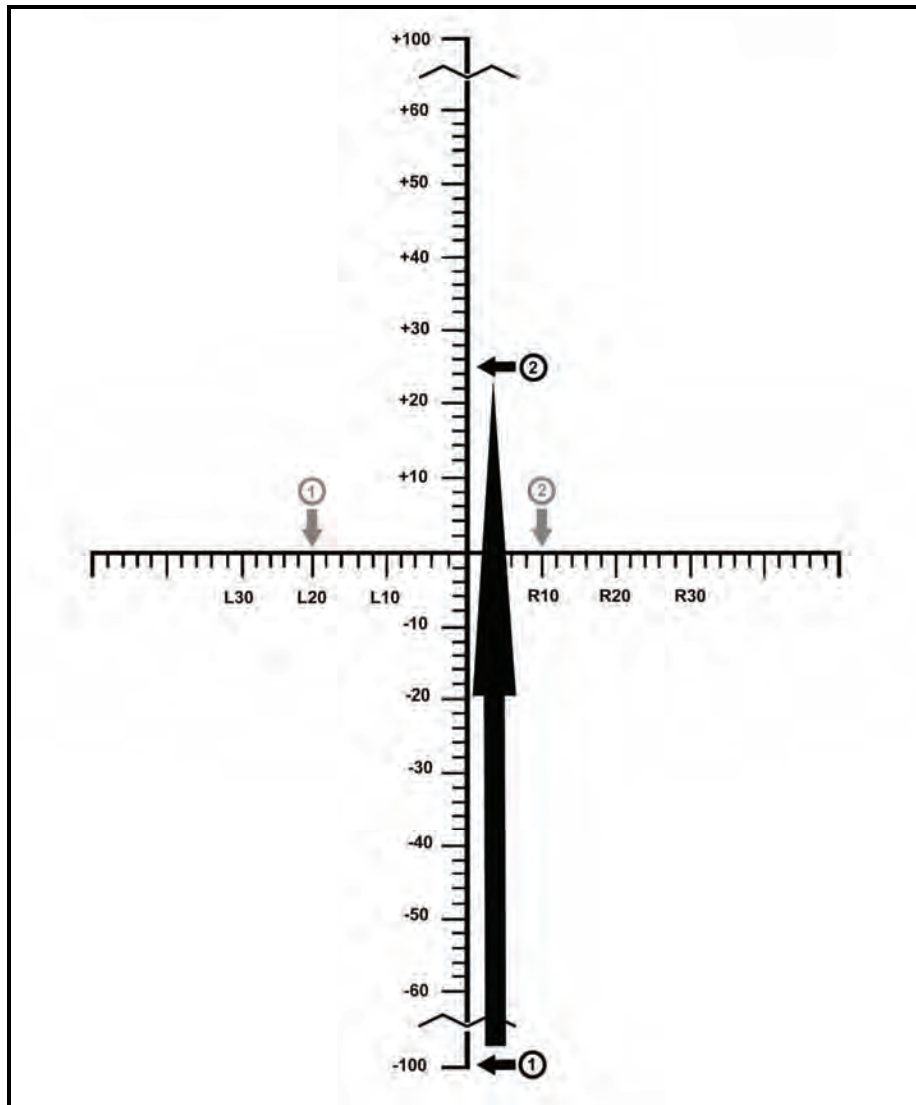

Figure 4-25. Updated registration corrections, range.

EXAMPLE

MET messages on the same side of the MET cross (Figure 4-26).

Assume that:	MET 1:	Deflection correction L30 Range correction +50
	MET 2:	Deflection correction L40 Range correction +75 Deflection correction L30 + L40 = L10 Range correction +50 + 25

4-79. Always use this procedure to determine corrections. Remember, MET 1 is compared to MET 2, and MET 2 to MET 3. This procedure continues as long as MET messages are received and the unit remains in the same position.

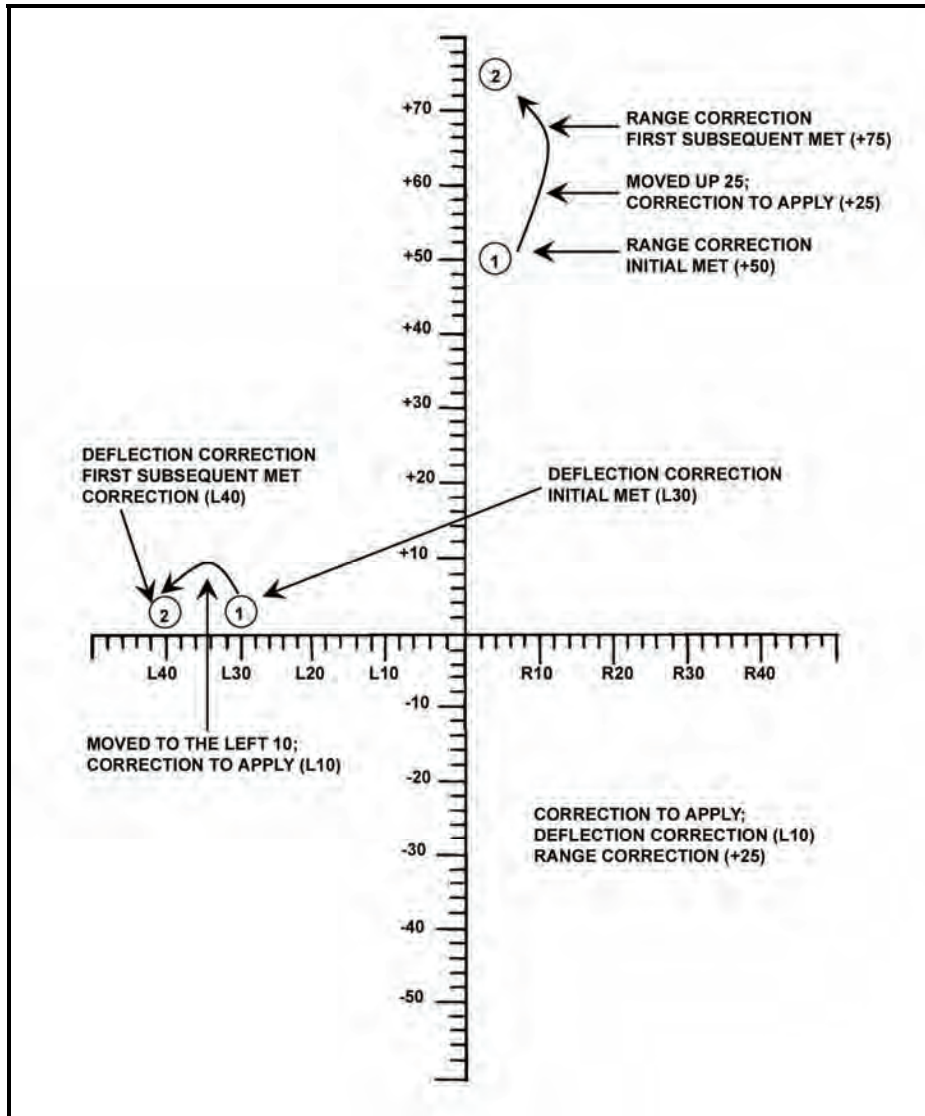

Figure 4-26. Deflection and range corrections.

4-80. Once MET corrections have been determined, the FDC can determine the corrections for updating the MET. MET is based on the RP; therefore, MET corrections are applied to corrections determined from the registration.

RANGE CORRECTION

4-81. Compare the range correction from the RP and the MET range correction. For different signs, subtract the smaller from the larger, and use the sign of the larger for the new range correction for the RP. If the signs are the same, add the values.

EXAMPLE

Range correction from the registration +150
Range correction from the METS +25
+150 + 25 = +175 range correction

RANGE CORRECTION FACTOR

4-82. Once the range correction has been determined, the FDC determines the range correction factor (RCF) by dividing the initial chart range (rounded to the nearest hundred and expressed in thousandths) into the range correction.

EXAMPLE

New range correction: +175
Initial chart range: 3,050
(100's = 3100; 1000's = 3.1)

$$+3.1 / +175.0 \frac{+56.4}{} = +56 \text{ RCF}$$

Deflection correction from registration L12
Deflection correction from METs R10

L2= DEF CORR

4-83. Once the new corrections have been determined, the FDC updates the DA Form 2188-1-R (RP and previously fired targets). Because the chart is based on the RP, the FDC updates it first.

This page intentionally left blank.

Chapter 5

Call for Fire

A CFF is a concise message prepared by the observer. It contains all of the information that the FDC needs to determine the method of target attack.

INTRODUCTION

5-1. The CFF is a request for fire from the observer. The observer must send it quickly, yet clearly enough for the FDC to understand, record, and read it back without error.

5-2. The CFF is sent in three transmissions consisting of six elements with a break and a read-back after each transmission. The transmissions and elements are as follows:

- The first transmission consists of—
 - Observer ID.
 - Warning order.
- The second transmission consists of—
 - Target location.
- The third transmission consists of—
 - Target description.
 - Method of engagement (optional).
 - Method of fire and control (optional).

NOTE: When the observer sees a target, he should notify the RTO so the RTO can begin the CFF while the target location is determined. The RTO sends the information as it is determined, instead of waiting until a complete CFF has been prepared.

5-3. Further, CFFs typically require authentication.

OBSERVER IDENTIFICATION

5-4. Observer identification tells the FDC who is calling for fire. It consists of appropriate call signs or codes needed to establish contact between the observer and the FDC.

WARNING ORDER

5-5. The warning order clears the net for the fire mission. The warning order consists of the—

- Type of mission.
- Size of the element to FFE (optional).
- Method of target location.

TYPES OF MISSIONS

5-6. There are four types of missions for a warning order:

- Adjust fire.
- Fire for effect.
- Suppress.
- Immediate suppression or immediate smoke.

Adjust Fire

5-7. When the observer decides that an adjustment is needed because of a questionable target location or lack of registration corrections, he announces, "Adjust fire (A/F)."

Fire for Effect

5-8. The observer should always strive for first-round FFE. The accuracy required to FFE depends on the target and the ammunition being used. When the observer is certain that the target location is accurate and that the first volley will have the desired effect on the target with little or no adjustment, he announces, "Fire for effect."

Suppress

5-9. To quickly bring fire on an inactive target, the observer announces, "Suppress (target identification number)." Suppression missions are normally fired on preplanned targets, and the duration is associated with the CFF.

Immediate Suppression or Immediate Smoke

5-10. When engaging a planned target or target of opportunity that has taken friendly maneuver or aerial elements under fire, the observer announces, "Immediate suppression (IS)." If the desired effect is a hasty screen for obscuration, the FO announces, "Immediate smoke."

SIZE OF THE ELEMENT TO FIRE FOR EFFECT

5-11. The observer may request the size of the unit to FFE.

METHODS OF TARGET LOCATION

5-12. This element enables the FDC to plot (M16/M19 plotting board) or enter (MBC/MFCS/LHMBC) the location of the target so that personnel can determine firing data.

GRID

5-13. If the target is located using the grid method, the FO announces, "Grid (six-digit grid coordinates for typical mission; eight-digit grid coordinates for RPs or other points for which greater accuracy is required)." Since the FDC does not need the OT direction to locate the target, the observer sends the direction (to the nearest 10 mils) at the end of the CFF or just before the initial correction.

SHIFT FROM A KNOWN POINT

5-14. If the target is located using the shift from a known point method, the FO announces, "Shift from known point (known point designation or target number)." In a shift from a known point mission, both the observer and the FDC must know the point from which the shift will be made; the observer announces it in the warning order. The observer then sends the OT direction. Normally, direction to the target will be sent to the nearest 10 mils; however, the FDC can use mils, degrees, or cardinal directions, whichever is specified by the observer. Next, the observer sends the lateral shift (the target's distance left or right of the

known point, expressed to the nearest 10 meters), the range shift (the target's distance farther [add] or closer to [drop] the known point, expressed to the nearest 100 meters), and the vertical shift (the target's distance above [up] or below [down] the known point, expressed to the nearest 5 meters).

NOTE: The vertical shift is ignored unless it exceeds 30 meters.

POLAR PLOT

5-15. If the target is located using the polar plot method, the observer announces, "Polar," in the warning order to alert the FDC that the target will be located with respect to the observer's position, which must be known to the FDC. The observer sends the direction (to the nearest 10 mils) and distance (to the nearest 100 meters) to the target from his position. A vertical shift (to the nearest 5 meters) tells the FDC how far the target is located above (up) or below (down) the observer's location. Vertical shift may also be described by a vertical angle (VA) in mils relative to the observer's location; this method is used when conducting a laser polar plot mission.

TARGET DESCRIPTION

5-16. The section sergeant selects different ammunition for different types of targets. The observer must describe the target in detail to allow the section sergeant to determine the amount and type of ammunition to use. The observer's description should be brief, but accurate, and contain the following:

- What the target is (troops, equipment, supply dump, trucks).
- What the target is doing (digging in, establishing an assembly area).
- The number of elements in the target (squad, platoon, three trucks, six tanks).
- The degree of protection (in the open, in fighting positions, in bunkers with overhead cover).
- The target size and shape, if significant.
 - When the target is rectangular, the observer should give the length and width in meters, and the attitude (azimuth of the long axis) to the nearest 100 mils. For example, 400 meters by 100 meters; attitude 2600.
 - When the target is circular, the observer should give the radius.
 - The observer may describe linear targets using length, width, and attitude.

METHOD OF ENGAGEMENT

5-17. The observer may indicate how he wants to attack the target. This element consists of the—

- Type of adjustment.
- Ammunition.
- Distribution of fire.

TYPE OF ADJUSTMENT

5-18. In an adjustment, area or precision fire may be used.

Area Fire

5-19. If no specific type of adjustment is designated, area fire will be used. Split a 100-meter bracket to achieve area fire.

Precision Fire

5-20. Precision fire is conducted with one weapon engaging a point target. Currently the only precision mortar mission is registration. Registration is initiated by the FDC and is used to determine corrections for subsequent missions.

Danger Close

5-21. The observer includes the term “danger close” in the method of engagement when the target is located within 600 meters of friendly troops for mortars and cannon artillery, 750 meters for 5-inch naval guns.

AMMUNITION

5-22. If the observer does not request a specific projectile or fuze, he is given shell HE, fuze IMP.

5-23. The observer may initially request one type of projectile or fuze, and then request another type to complete the fire mission.

Smoke

5-24. When the observer requests smoke, the chief computer normally directs the use of HE for the adjustment phase and WP for the completion of the adjustment and FFE.

Combination of Projectiles or Fuzes

5-25. When the observer wants a combination of projectiles or fuzes in effect, he must state so in this element of the CFF. For example, the observer may request, “HE and WP in effect” or “IMP and PROX in effect.”

Volume of Fire

5-26. The observer may also request the volume of fire he needs for FFE. If the observer does not specify the number of rounds to be fired in effect, the FDC should notify the observer of the number of rounds that will be fired in effect.

DISTRIBUTION OF FIRE

5-27. A linear sheaf is fired on an area target in FFE. When another type of sheaf is desired, the observer must announce the type of sheaf desired; for example, “Converged” or “Open sheaf.”

METHODS OF FIRE AND CONTROL

5-28. The methods of fire and control indicate the desired manner of attacking the target, whether the observer wants to control the time of delivery of fire, or if the observer can observe the target. The observer announces the methods of fire and control using the terms discussed below.

METHOD OF FIRE

5-29. Adjustment is normally conducted with the number two mortar. The observer may request any weapon or combination of weapons to adjust. For example, if the observer wants to see where each of the mortars in a section hits, he may request, “Section right (left).”

5-30. The normal interval of time between the rounds fired by a section right or left is 10 seconds. If the observer wants another interval, he may so specify.

METHOD OF CONTROL

5-31. The control element indicates the type of control that the observer exercises over the time of fire delivery and if any or no adjustments are to be made. In the absence of observer control, the firing section fires when ready (W/R) or under the FDC's control. The observer announces the method of control using the following terms:

- At my command.
- Cannot observe.
- Time on target.
- Continuous illumination.
- Coordinated illumination.
- Cease fire.
- Check fire.
- Continuous fire.
- Repeat.
- Followed by.

At My Command

5-32. "At my command (AMC)" indicates that the observer wants to control the delivery of fire.

5-33. The observer announces, "At my command," immediately before the adjust fire or FFE. When the weapons are ready to fire, FDC personnel announce, "Section is ready." Then, when the observer wants the mortar section to fire, he announces, "Fire." This method of control remains in effect until the observer announces, "Cancel at my command" or "End of mission."

Cannot Observe

5-34. This announcement indicates that the observer cannot adjust fire, but he believes that a target exists at the given location, and the target is important enough to justify firing upon it without adjustment.

Time on Target

5-35. The observer may tell the FDC when he wants the rounds to impact by requesting, "Time on target (number desired) minutes from now" or "Time on target (time desired) hours." The observer must conduct a time check to ensure that his timepiece is synchronized with the FDC's timepiece.

Continuous Illumination

5-36. If the observer has not given an interval, the section sergeant determines the interval by the burn time of the illuminating ammunition in use. If another interval is required, it is indicated in seconds.

Coordinated Illumination

5-37. While the preferred method is to have the FDC compute the interval between HE and illuminating rounds, the observer may order this interval in seconds. This command causes the HE round to impact at the point of optimum illumination, or the observer may use AMC procedures.

Cease Fire

5-38. This command is used to stop the loading of rounds into mortars when firing two or more rounds. Gun sections may fire any rounds that have already been loaded (hung rounds).

Check Fire

5-39. This command is used to cause an immediate halt in firing.

Continuous Fire

5-40. In mortars, this command means loading and firing as rapidly as possible, consistent with accuracy and within the prescribed rate of fire for the mortar being used. Firing continues until suspended by the commands "Cease loading" or "Check fire."

Repeat

5-41. This command can mean one of two things:

- During adjustment, "Repeat" means to fire another round(s) using the last data and adjust for any change in ammunition.
- During FFE, "Repeat" means to fire the same number of rounds using the same method of FFE. Changes to the number of guns, gun data, interval, or ammunition may be requested.

Followed By

5-42. This term is used to indicate a change in the rate of fire, the type of ammunition, or another order for FFE.

MESSAGE TO OBSERVER

5-43. After receiving the CFF, the FDC determines if and how the target will be attacked. That decision may be announced to the observer in the form of a message to observer (MTO).

5-44. The MTO consists of the following four items:

- Unit(s) to fire.
- Changes to the CFF.
- Number of rounds.
- Target number.

5-45. The following information can also be transmitted in the MTO:

- Angle T.
- Time of flight.

UNIT(S) TO FIRE

5-46. This element consists of the number of mortars that will fire the mission.

EXAMPLE

In a four-gun 120-mm mortar platoon, two guns are already involved in a fire mission. The other two are available, but the FDC only wants to use one mortar on the new target. The FDC would announce to the observer, "One gun."

CHANGES TO THE CALL FOR FIRE

5-47. This element contains any changes to the CFF.

EXAMPLE

The observer requested IMP in effect, and the FDC decides to fire PROX in effect.

NUMBER OF ROUNDS

5-48. This element contains the number of rounds for each tube in FFE.

TARGET NUMBER

5-49. A target number is assigned to each mission to help the processing of subsequent corrections.

ANGLE T

5-50. The FDC sends angle T to the observer when it is equal to or greater than 500 mils or when requested.

NOTE: See Chapter 4 for more information about angle T.

TIME OF FLIGHT

5-51. The FDC sends time of flight to an observer during moving target or aerial observer missions, or when requested.

NOTE: See FM 6-30 for more information about MTOs.

CALL FOR FIRE FORMAT

5-52. The following is the format for a CFF.

- Observer identification
- Warning order
 - Adjust fire
 - Fire for effect
 - Suppression
 - Immediate suppression/smoke
- Target location
 - Grid coordinates: direction
 - Shift from a known point
 - Direction
 - Lateral shift
 - Range shift
 - Vertical shift
 - Polar plot coordinates
 - Direction
 - Distance
 - Vertical shift from the observation point (OP)

- Target description
- Method of engagement
 - Type of adjustment
 - Area
 - Precision (registration)
 - Danger close
 - Ammunition and fuze
 - Distribution
 - Linear sheaf
 - Parallel sheaf
 - Open sheaf
 - Converged sheaf
 - Special sheaf
 - Traversing fire
 - Searching fire
 - Range spread, lateral spread, or range lateral spread (illumination only)
- Method of fire and control
 - Method of fire
 - Method of control
 - Fire when ready
 - At my command
 - Cannot observe
 - Time on target
 - Continuous illumination
 - Coordinated illumination
 - Cease firing
 - Check firing
 - Continuous fire
 - Repeat
 - Request splash
 - Do not fire

AUTHENTICATION

5-53. Authentication is considered a normal element of the initial request for indirect fire. Two methods of authentication are authorized for use:

- Challenge and reply.
- Transmission.

5-54. Challenge and reply authentication requires two-way communications, whereas transmission authentication does not. Challenge and reply authentication is used when possible.

CHALLENGE AND REPLY AUTHENTICATION

5-55. The FDC inserts the challenge in the last read-back of the CFF. The FO transmits the correct authentication reply immediately following the challenge. Authentication replies exceeding 20 seconds are automatically suspect, and the FDC may rechallenge. Subsequent adjustments of fire or immediate engagement of additional targets by the FO who originated the fire request normally do not require continued challenge.

TRANSMISSION AUTHENTICATION

5-56. Transmission authentication is used only if authentication is required and it is not possible or desirable for the receiving station to reply; for example, message instruction, imposed radio silence, and FPF and IS.

5-57. The observer is given a transmission authentication table in accordance with the unit SOP. The table consists of 40 columns with authenticators in each column. After each authenticator is used, a line may be drawn through it to avoid using the same one again.

This page intentionally left blank.

Part Three

Mortar Ballistic Computer

Chapter 6

Introduction

This chapter outlines the description, audio alarm characteristics, capabilities, and memory storage of the MBC.

DESCRIPTION

6-1. The M23 MBC (Figure 6-1) is handheld, lightweight, and battery-powered. It is used for automated computations, digital communications, and displaying mortar-related information. The MBC weighs seven pounds (including the battery) or eight pounds (including the battery and case assembly). It is portable, can be used in all-weather operations, and has built-in self-test circuits. The MBC requires fire mission data input to compute fire commands needed to effectively execute a mortar fire mission. When the MBC is connected to an external communication device, such as a digital message device (DMD) or the forward observer system (FOS), the FO fire mission inputs are automatically entered and may be reviewed and edited by the MBC operator. When the MBC is not connected to an external communication device, the MBC operator manually enters all fire mission data. The fire commands are then relayed to the gun line in accordance with the unit standing operating procedures (SOP).

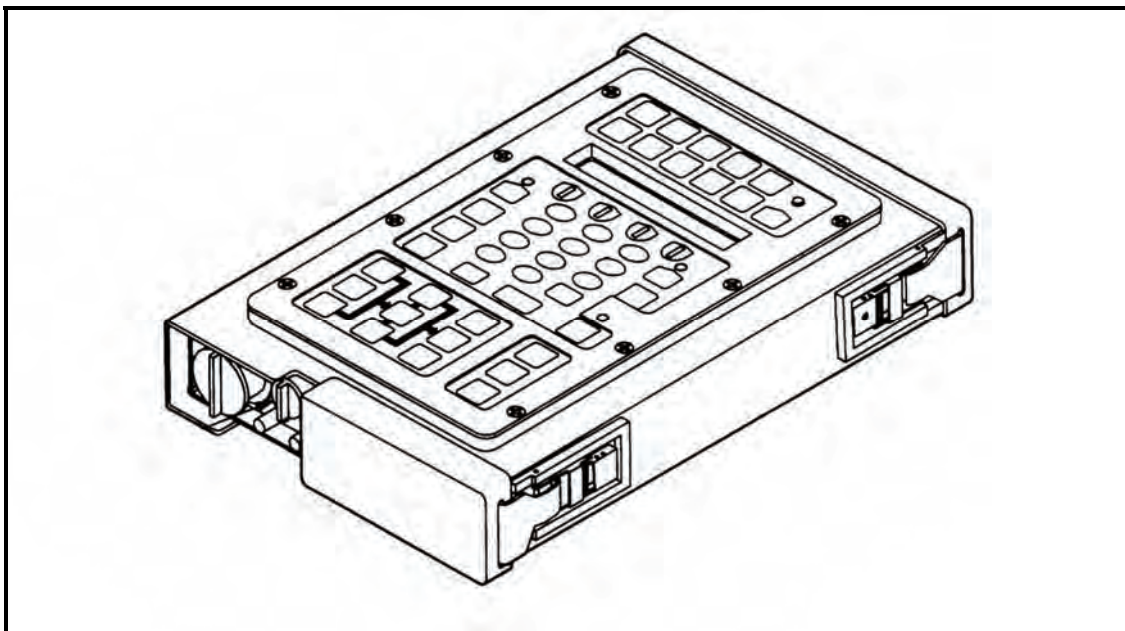

Figure 6-1. Mortar ballistic computer.

INITIALIZATION SWITCHES

6-2. The initialization switches (Figure 6-2) for the MBC include—

- SET UP switch.
- WPN DATA switch.
- FO LOC switch.
- REG DATA switch.
- BRT switch.
- ON/OFF switch.
- FIRE ZONES switch.
- MET switch.
- KNPT/TGT switch.
- AMMO DATA switch.
- TEST switch.

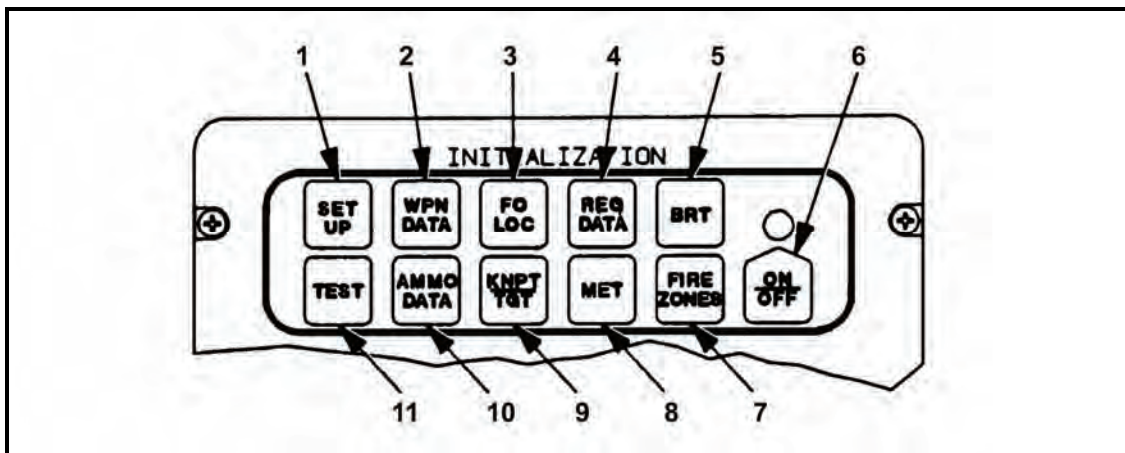

Figure 6-2. Initialization switches.

SET UP Switch

6-3. The SET UP switch (1, Figure 6-2) displays the menu for entering setup data. This menu contains the following:

- Timeout.
- Target prefix and block number range.
- Audio alarm.
- Minimum easting and northing coordinates.
- Location grid declination.
- Latitude.
- Listen-only mode.
- Message transmission rate.
- Transmitter warm-up delay time.
- Single or double message block mode.
- Owner identification.

WPN DATA Switch

6-4. The WPN DATA switch (2, Figure 6-2) displays menus for entering or reviewing weapon data for each unit. This menu allows the operator to select as many as three firing sections and allows him to enter—

- As many as six individual gun locations for each section.
- The weapon type, carrier- or ground-mounted, altitude, azimuth of fire (AOF), and referred deflection being used.

FO LOC Switch

6-5. The FO LOC switch (3, Figure 6-2) displays a menu for entering data. This menu contains the following:

- FO number (12 FOs maximum).
- Grid location.
- Altitude.

REG DATA Switch

6-6. The REG DATA switch (4, Figure 6-2) displays menus for manually entering a registration data file for an RP or reviewing RP data. These menus contain the following:

- ORP number.
- Location.
- Altitude.
- Weapon unit and number.
- Charge for 60-, 81-, and 120-mm mortars.
- Type of MET data used when the RP was fired, including range and deflection correction factors.

BRT Switch

6-7. The BRT switch (5, Figure 6-2) controls the level of brightness for the display area and the background lighting for the keyboard.

-
- NOTES:**
1. The MBC can be operated in total darkness if the brightness is set at low.
 2. When set at low, the keyboard is still lit.
-

ON/OFF Switch

6-8. The ON/OFF switch (6, Figure 6-2) turns the MBC on or off.

NOTE: When turned on, the display temporarily shows "POWERUP TEST," and then shows "READY."

FIRE ZONES Switch

6-9. The FIRE ZONES switch (7, Figure 6-2) displays menus for entering or reviewing fire zone and fire line boundaries. These menus contain the following:

- Location points for fire lines.
- Zone numbers.
- Number of points for a fire zone (no-fire area).
- Location points for fire zone boundaries.

MET Switch

6-10. The MET switch (8, Figure 6-2) displays menus for entering nonstandard MET data. These menus contain the following:

- MET station data and location.
- Nine lines of MET data, including wind direction, speed, temperature, and pressure for each line.

KNPT/TGT Switch

6-11. The KNPT/TGT switch (9, Figure 6-2) displays menus for entering known points or target reference points. These menus contain the following:

- Known point or target number.
- Grid location.
- Altitude.

AMMO DATA Switch

6-12. The AMMO DATA switch (10, Figure 6-2) displays menus for entering ammunition data for each caliber of weapon in use. These menus contain the following:

- Ammunition types.
- Powder temperature change.
- Correction factors for projectile weight.

TEST Switch

6-13. The TEST switch (11, Figure 6-2) allows the user to manually begin a self-test of the microprocessor (ROM, RAM, and instruction set) for all switches and keys, the display (character generation), the modem (communication device), the software revision number, and communications (transmit test message).

ACTION SWITCHES

6-14. The action switches (Figure 6-3) include—

- MSG switch.
- SEQ switch.
- BACK switch.
- XMIT switch.
- CLEAR ENTRY switch.
- COMPUTE switch.
- EOM switch.
- MSN switch.
- SURV switch.
- REVIEW switch.

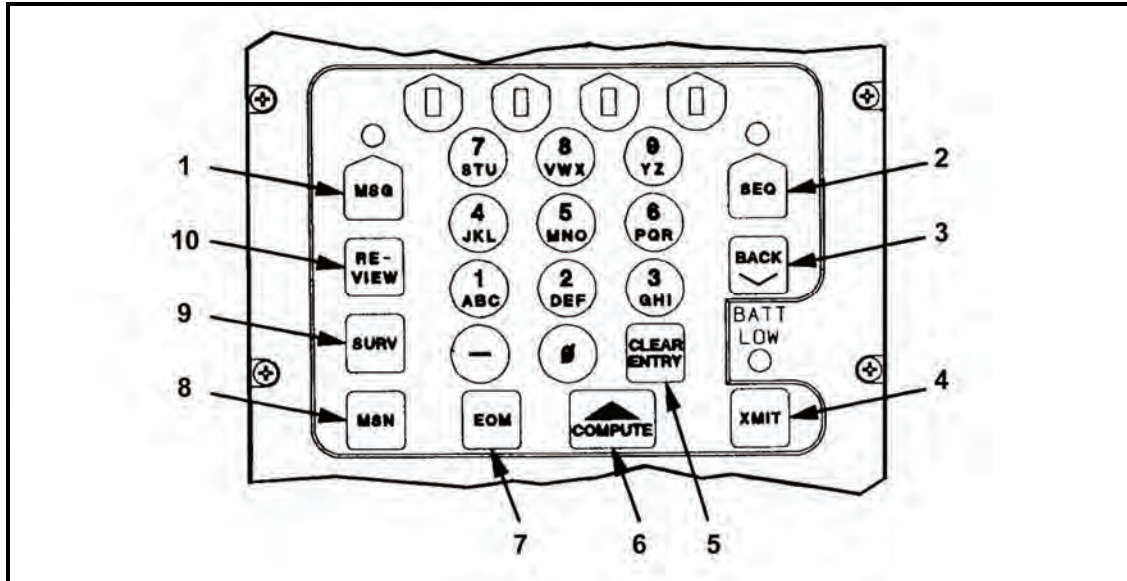

Figure 6-3. Action switches.

MSG Switch

6-15. The MSG switch (1, Figure 6-3) displays the first line of a message transmitted by a DMD.

SEQ Switch

6-16. The SEQ switch (2, Figure 6-3) displays the next line of a menu to allow viewing or entry of data.

NOTE: Press the SEQ switch to store data entered from the keyboard.

BACK Switch

6-17. The BACK switch (3, Figure 6-3) displays the previous menu line to allow reviewing or data changes.

XMIT Switch

6-18. The XMIT switch (4, Figure 6-3) starts MTO and command message to observer (CMD) menus for entering and transmitting firing information to the observer.

CLEAR ENTRY Switch

6-19. The CLEAR ENTRY switch (5, Figure 6-3) removes the last (right-most) character from a data field and allows re-keying of an entry.

COMPUTE Switch

6-20. The COMPUTE switch (6, Figure 6-3) initiates computation of fire mission data, survey data, registration data, and adjustments.

EOM Switch

6-21. The EOM switch (7, Figure 6-3) displays menus for manually entering end-of-mission instructions, such as delete all mission data or end the active mission, and storing the final target grid location in the target file.

MSN Switch

6-22. The MSN switch (8, Figure 6-3) displays menus for reviewing current fire mission data and assigning a mission number, which makes the mission operational, allows changes to mission buffers, and enables corrections to a subsequent mission to be applied.

SURV Switch

6-23. The SURV switch (9, Figure 6-3) displays menus for manually entering survey data for computation.

- Survey types are resection, intersection, and traverse.
- Data entries are horizontal and vertical angles, and distances.

6-24. Computed answers may be stored as a known point, target, FO location, or base mortar location.

REVIEW Switch

6-25. The REVIEW switch (10, Figure 6-3) returns the display to the first line of a message or to a main menu currently in use.

ALPHANUMERIC AND MINUS SIGN KEYS

6-26. Eleven keys are used to enter alphanumeric characters and the minus sign (Figure 6-4). For combination keys, alpha or numeric selection is either automatic or menu-selectable.

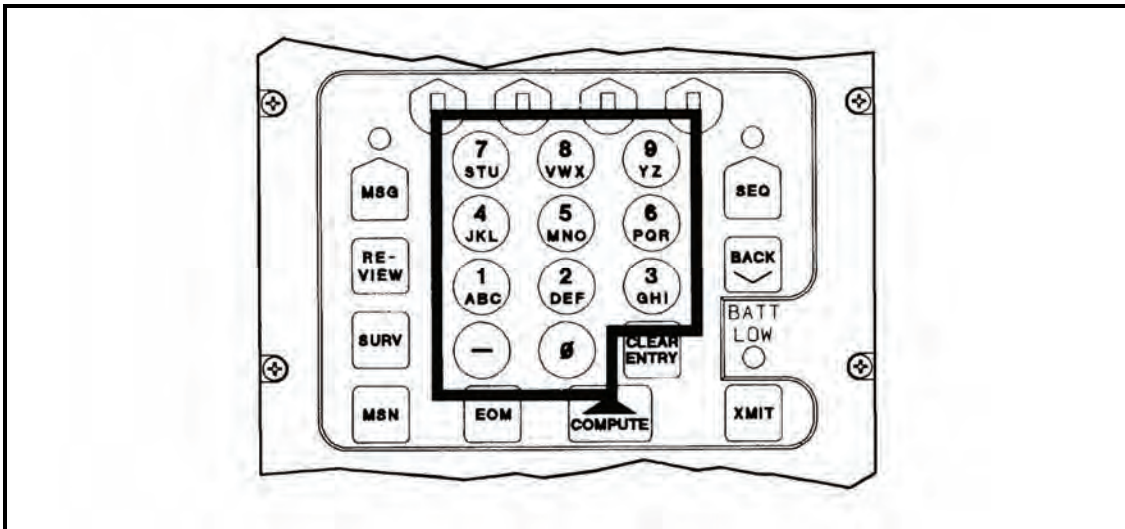

Figure 6-4. Alphanumeric and minus sign keys.

FIRE MISSION KEYS

6-27. The fire mission keys (Figure 6-5) include—

- GRID key.
- ADJ key.
- REG key.
- TFC key.
- FPF key.
- WPN/AMMO key.
- BURST key.
- POLAR key.
- SHIFT key.

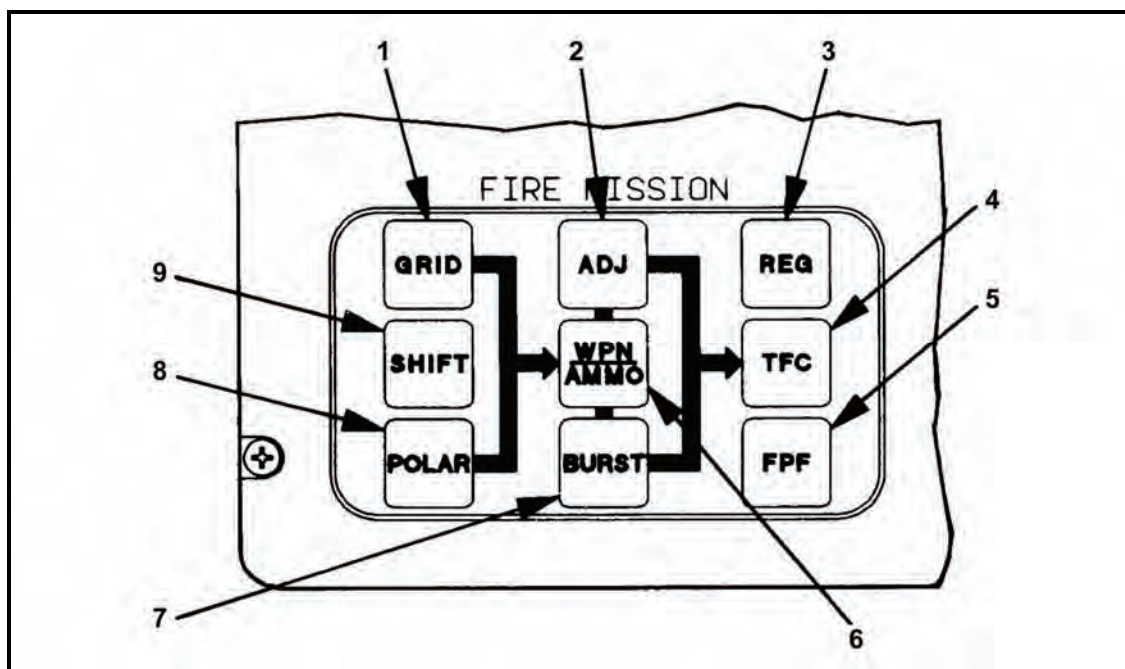

Figure 6-5. Fire mission keys.

GRID Key

6-28. The GRID key (1, Figure 6-5) is used to manually enter grid fire mission data when the target location is identified by grid coordinates. Entries are—

- FO ID number.
- FO direction to target.
- Target location.
- Altitude, when known.

ADJ Key

6-29. The ADJ key (2, Figure 6-5) is used to manually enter fire mission adjustment data (corrections) from the FO. Correction entries are—

- Left or right deviations.
- Plus or minus range.
- Up or down height.

REG Key

6-30. The REG key (3, Figure 6-5) is used to review registration data, and to compute and store RP correction factors. The computation results in a range correction factor and a deflection correction amount.

TFC Key

6-31. The TFC key (4, Figure 6-5) is used to manually enter or change technical firing data, such as the sheaf, method of control, and weapons to fire.

FPF Key

6-32. The FPF key (5, Figure 6-5) is used to manually enter the FPF line data, safety fan, and minimum/maximum charge. Entries are—

- FPF location.
- Target altitude.
- Target width.
- Attitude.

WPN/AMMO Key

6-33. The WPN/AMMO key (6, Figure 6-5) is used to manually enter or change the weapon or ammunition data for a fire mission. Entries are—

- Weapon unit and number (A section, number 3 gun).
- Shell and fuze combination.
- Charge (60- and 81-mm mortars).

NOTE: When 120-mm mortar data becomes available, the computer must be updated.

BURST Key

6-34. The BURST key (7, Figure 6-5) is used to manually enter burst location data (corrections) supplied by a laser-equipped FO. Entries, from laser to burst, are—

- Direction.
- Distance.
- Vertical angle.

POLAR Key

6-35. The POLAR key (8, Figure 6-5) is used to manually enter polar plot data for normal and laser-designated polar plot fire missions.

- Normal polar plot mission targets are identified by direction, distance, and up/down height from an FO.
- Laser polar plot mission targets are identified by laser direction, laser distance, and laser vertical angle.

SHIFT Key

6-36. The SHIFT key (9, Figure 6-5) is used to manually enter shift from a known point fire mission data when a target location is identified using a shift from a known point. Entries are—

- FO ID.
- Known/target number of direction to target.
- Direction.
- Amount of shift.

OUTPUT SWITCHES

6-37. The output switches (Figure 6-6) include—

- FIRE DATA switch.
- SFTY DATA switch.
- REPLOT switch.

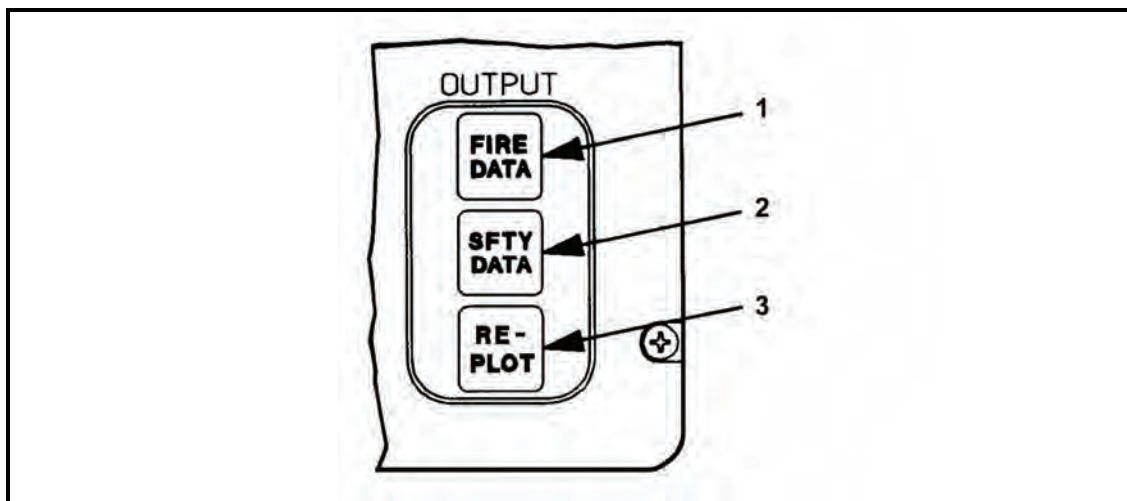

Figure 6-6. Output switches.

FIRE DATA Switch

6-38. The FIRE DATA switch (1, Figure 6-6) is used for reviewing the fire commands of active fire missions. Data are the same as the COMPUTE switch output.

SFTY DATA Switch

6-39. The SFTY DATA switch (2, Figure 6-6) allows the operator to review safety factors by accessing data menus for active fire missions. These menus allow the operator to enter boundaries for a safe firing area or a minimum and maximum charge for the safety area.

REPLOT Switch

6-40. The REPLOT switch (3, Figure 6-6) is used to review target replot data and to increase target location accuracy.

6-41. To compute a new grid location, the operator enters a new target altitude, and then presses the REPLOT switch.

DISPLAY SWITCHES

6-42. The display area features up to 16 alphanumeric characters (Figure 6-7). A flashing character block signals a need for an operator action. To respond, the operator presses the display switch below the flashing block or the SEQ switch. Any combination of blocks (or none) may flash. If no block is flashing, no action is required, and the operator cannot change what is shown on the display.

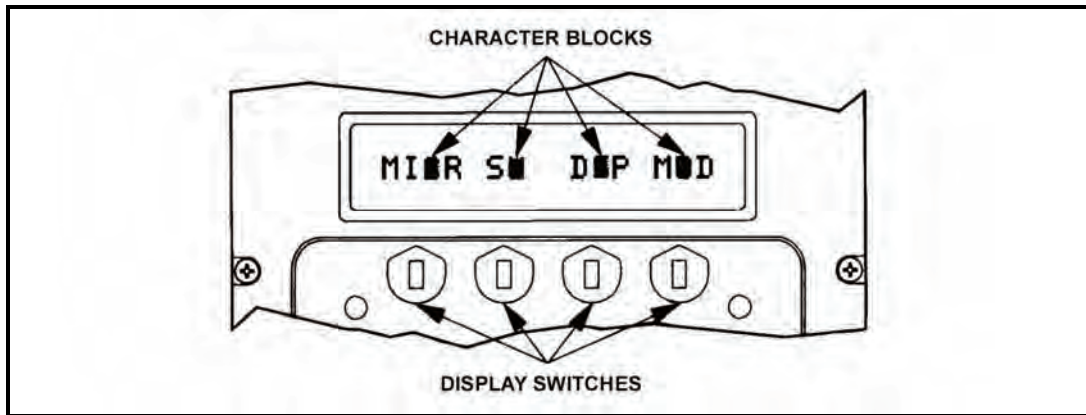

Figure 6-7. Display switches.

LIGHT-EMITTING DIODE INDICATORS

6-43. The corresponding keys for the light-emitting diode (LED) indicators (Figure 6-8) include—

- Standby indicator.
- Sequence indicator.
- BATT LOW indicator.
- Message indicator.

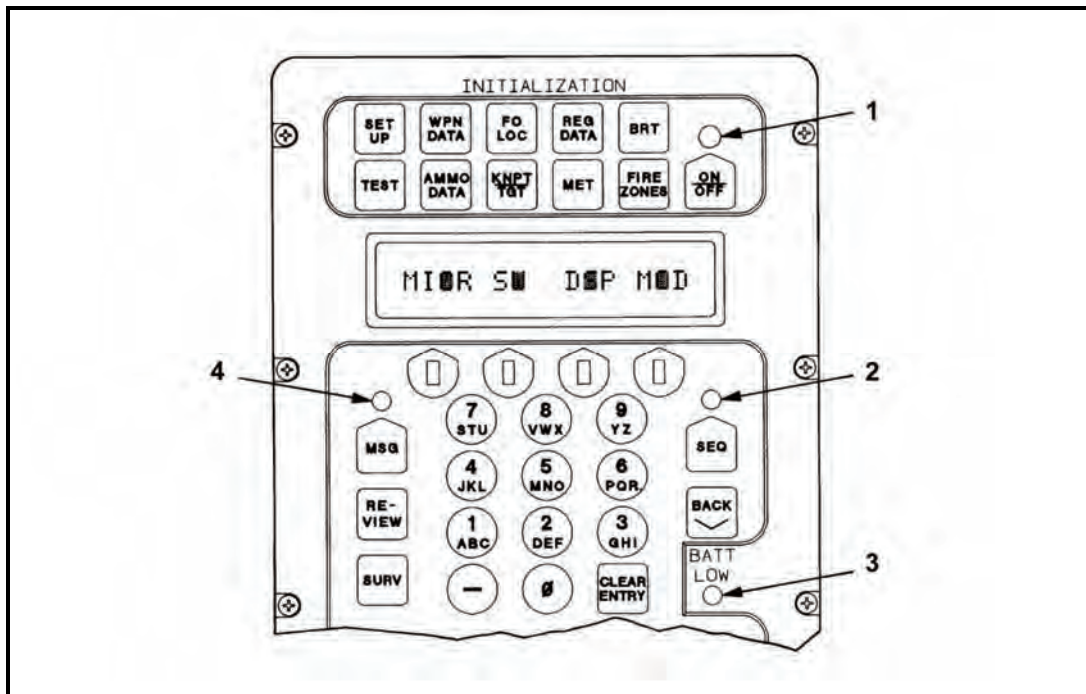

Figure 6-8. Light-emitting diode indicators.

Standby Indicator

6-44. The standby indicator (1, Figure 6-8) flashes when the display timeout period has expired. It flashes once every six seconds while the display is “timed out.” To return to the last display, press any key once.

NOTE: Using the FIRE MISSION keys to turn the display back on is not recommended. Some of these keys are highly sensitive and a fire mission can be initiated accidentally. The safest key to use is the sequence key.

Sequence Indicator

6-45. The sequence indicator (2, Figure 6-8) flashes when more data are available for the current menu or display.

BATT LOW Indicator

6-46. The BATT LOW indicator (3, Figure 6-8) flashes when the internal 12-volt battery is low. This indicator starts flashing when the battery output reaches 11 volts, and the MBC shuts off at 10 volts. If the BATT LOW indicator starts flashing during a fire mission, continue with the mission, and change the battery as soon as possible.

Message Indicator

6-47. The message indicator (4, Figure 6-8) flashes when the MBC has received one or more digital messages. The flash rate increases with the number of messages received. Flash rates are:

- 1.25 times per second = one message.
- 2.5 times per second = two or more messages.
- 5 times per second = one or more FO CMD messages.

AUDIO ALARM

6-48. The internal audio alarm beeps continuously when digital messages are received. The alarm beeps noticeably faster for an FO CMD message than for other message types. To turn off the beeping alarm, the operator presses any switch or key.

NOTE: To turn the alarm off or on, access the SET UP switch function.

CAPABILITIES

6-49. The MBC communicates with the DMD. There are two types of incoming messages: fire request messages and information-only messages. When the message indicator is lit or the audio alarm sounds and the MSG switch is pressed, the first line of the first message received is displayed. When the message is a fire mission, the MBC automatically assigns a mission and target number, unless three active fire missions are in progress. If so, the MBC displays, “NO AVAIL MSN,” and discards the message.

6-50. The MBC:

- Computes and applies registration and MET corrections.
- Computes firing data for all fire mission types.
- Allows mortar dispersion up to 999 meters from the basepiece.

6-51. The ammunition file in the MBC contains only the ammunition depicted in Table 6-1.

Table 6-1. Mortars and corresponding ammunition.

MORTAR TYPE OF AMMUNITION	M224, 60-mm MORTAR	M252 AND ##M29, 81-mm MORTARS	120-mm MORTAR	M303 INSERT, 81-mm MORTAR
HIGH-EXPLOSIVE	*M720 ##M49A4 M888	***M374 M374A2 M374A3 M821 M889 #M889A1 #M821A1	M933 *M934 ##M57	*M374 M374A2 M374A3
ILLUMINATION	*M83A3 M721	*M301A3 M853A1	M91 *M930	M301A3
WHITE PHOSPHORUS	*M302A1 #M302A2 M722	##M375 *M375A2 ##M375A3	##M68 *M929	M375 *M375A2 M375A3
RED PHOSPHORUS		M819		
TRAINING/PRACTICE		(Ground-mounted mode only) ***M1 ##M68 M879 #M880		M880
NOTE: * = Default ammunition # = Revision III/A ## = No longer in inventory				

MEMORY STORAGE CAPACITY

6-52. The MBC can store—

- 3 active fire missions.
- 3 messages in the message buffer.
- Up to 18 weapon systems—3 sections/platoons with up to 6 mortars each.
- 12 FO locations with their call signs.

NOTE: At this time, the MBC revision III/A does not allow entries with the same identifier. For example, once the identifier B02 is used, the number 02 cannot be used again.

- 50 known points/targets.
- 16 RPs.
- 3 firing sections.
- 10 no-fire zones with between 3 and 8 points each; 80 total points are available. All zones share the 80-point pool.
- 3 FPF files, 1 for each section/platoon.
- 3 safety fans, 1 for each section/platoon, with each diagram capable of having 10 fans (0 to 9).
- 1 no-fire line.

NOTE: Error messages may occur while using the MBC. Appendix F discusses the possible errors and provides actions to correct the problem.

This page intentionally left blank.

Chapter 7

Preparation of Fire Control Equipment

This chapter discusses the different types of data entry for the MBC. The different levels of initialization are also explained. Figure 7-1 provides an overview of the groupings of switches and indicators used when setting up the MBC for the tactical scene.

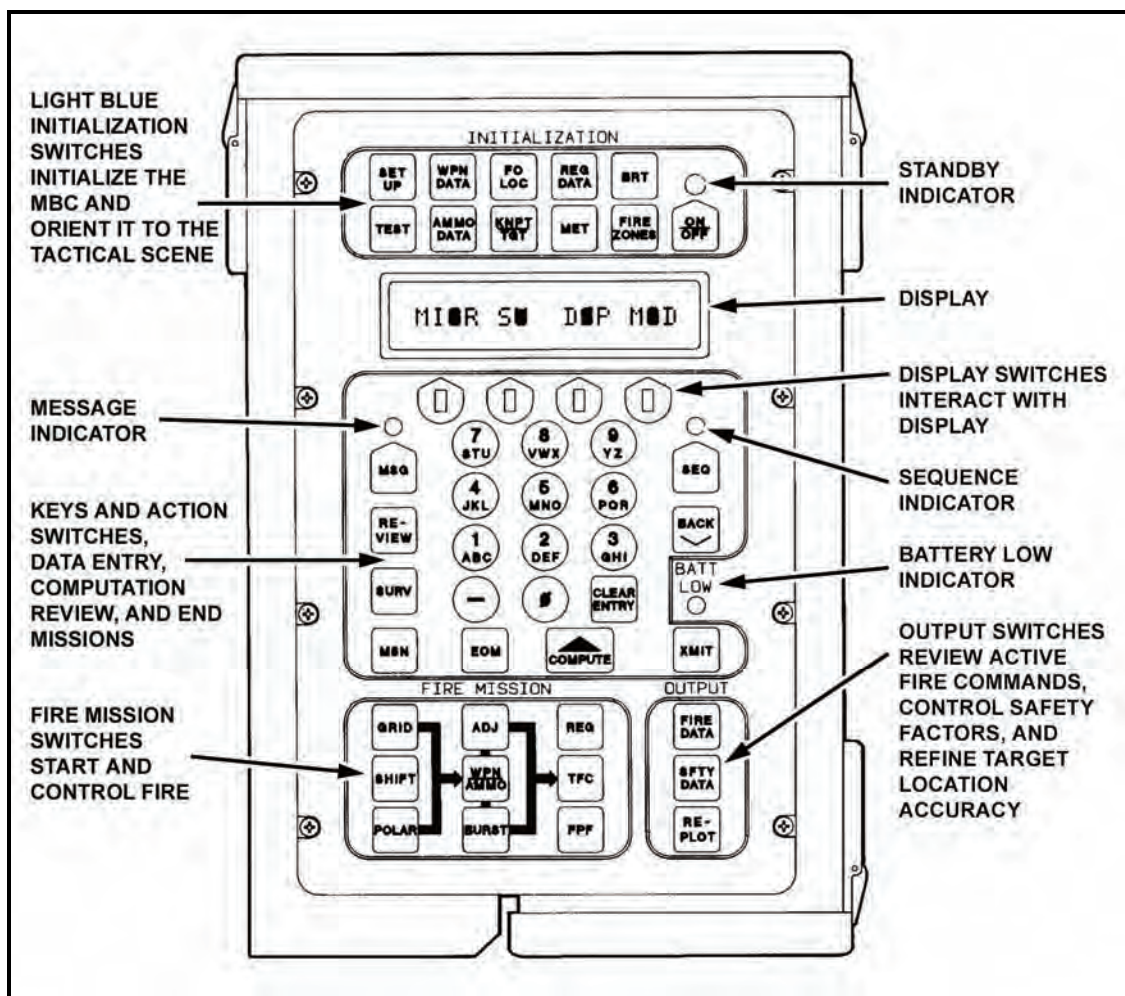

Figure 7-1. Mortar ballistic computer switch panel.

TYPES OF DATA ENTRY

- 7-1. The types of MBC data entry are—
- Default (computer-selected).
 - Alphabetical.
 - Numerical.
 - Correction.
 - Minimum easting and minimum northing.
 - Direction.
 - Multiple choice.
- 7-2. The following examples use only the SET UP menu to demonstrate each type of data entry. The data entry examples apply to all menus.
- 7-3. Before entering data, press the ON/OFF switch to activate the MBC. The display shows, “POWERUP TEST,” and then shows, “READY.”

NOTE: The self-test should be conducted when the MBC is turned on. However, the operator must first know how to make menu selections to conduct the self-test.

DEFAULT ENTRY

- 7-4. Default entries are those that the computer automatically uses until the operator manually changes the data. One example would be the default setup data:
- (1) Press the SET UP switch. The MBC displays the menu for setup data: timeout, target prefix, target number block, grid declination, message transmission rate, transmitter warm-up delay time, transmission single or double block mode, and owner identification.
 - (2) The display window of the MBC shows, “TIME OUT: 15.” Timeout means that the computer will automatically turn off the display if another switch is not selected before the given time runs out.

NOTE: The screen will darken if the time runs out. The computer is not off, just conserving energy. To reactivate the display screen, press any key (except the fire mission keys, which are Grid, Shift, and Polar).

- (3) The flashing cursor on the display indicates that the computer's timeout setting can be changed. The timeout can be set to 15, 30, 45, or 60 seconds. The computer defaults to a timeout period of 15 seconds, thereby maintaining the highest energy conservation. During training, the timeout period should be changed to 60 seconds.
- (4) Select the blue display switch beneath the flashing cursor in the display window. The display shows, “15 30 45 60,” with flashing cursors on each number. The four blue display switches interact with the numbers displayed directly above them. For example, if the switches were numbered from left to right (1, 2, 3, and 4), and the timeout is to be changed to 60 seconds, select display switch 4. The computer now shows, “TIME OUT: 60.”

ALPHABETICAL ENTRY

- 7-5. First, the operator must enter the alphabetical portion of the target number block, the target prefix. For example, the mortar platoon is assigned a target number block, AH0001 - AH0099. To enter the target prefix, AH, in the underlined blanks on the display—
- (1) Press the SEQ switch. The display shows, “TGT PRFX: _ _.”
 - (2) Press the 1/ABC key. The display shows, “A B C.” Since a numerical entry is not required at this time, the MBC automatically deletes the number 1 from the screen.

- (3) Press display switch 1 to select A. The display shows, "TGT PRFX:A _."
- (4) Press the 3/GHI key. The display shows, "G H I." Since a numerical entry is not required at this time, the MBC automatically deletes the number 3 from the display screen.
- (5) Press display switch 2 to select H. The display shows, "TGT PRFX:AH."
- (6) Once the prefix has been entered, press the SEQ switch to activate the computer's memory storage.

7-6. The target prefix selected will be used to identify all of the targets that are programmed into the MBC. The prefix will be used until changed or until the computer is cleared.

NUMERICAL ENTRY

7-7. After the SEQ switch is selected to store the target prefix, the display screen asks for the numerical half of the target block number, 0001 - 0099. The display shows, "TN:_____ - _____." To make the numerical entry—

- (1) Press the 0 key three times. The screen shows, "TN:0 0 0 _ - _____."
- (2) Press the 1/ABC key. Since an alphabetical entry is not required at this time, the MBC automatically displays the number 1. The display shows, "TN:0 0 0 1 - _____."
- (3) Press the 0 key twice and the 9/YZ key twice. Once again, since an alphabetical entry is not required at this time, the MBC automatically displays the number 9. The screen shows, "TN:0 0 0 1 - 0 0 9 9."
- (4) Press the SEQ switch to store the target block entries in the MBC's memory. The computer may now use the target numbers.

7-8. If a mistake is made when entering the target block numbers, the operator must make a correction entry.

7-9. If the SEQ switch is pressed before making the correction entry, press the BACK key to return to the last screen of information.

- Clearing the right-most character only.

EXAMPLE

The last digit entered for the target block number is a 9, but is supposed to be a 5.

- (1) Press the CLEAR ENTRY switch one time, and the display shows, "TN:0 0 0 1 - 0 0 9 _."
- (2) Now, select the proper number. Press the 5/MNO key. The display shows, "TN:0 0 0 1 - 0 0 9 5."

-
- Clearing the entire field.

EXAMPLE

During firing, your section leader tells you that the target block numbers have been changed from AH-0095 to AH-8000. The flashing cursors above display switches 1 and 3 indicate that both fields may be changed. To clear the entire field, in this case the 0095, follow these instructions:

- (1) Press display key 3. The field is cleared, and the display shows, "TN:0 0 0 1 - _____."
 - (2) Enter the new number by pressing the 8/VWX key once and the 0 key three times. The display shows, "TN:0 0 0 1 - 8 0 0 0."
-

CORRECTION ENTRY

7-10. A correction entry is any change made to the default alphabetical or numerical entries discussed in the paragraphs above.

NOTE: The ALARM OFF/ON function display is discussed in Chapter 9. Press the SEQ switch once to advance to the next display. The computer defaults the selection to "ALARM: OFF."

MINIMUM EASTING AND MINIMUM NORTHING ENTRIES

7-11. The next two displays, "MIN E:___000" and "MIN N:___000," are entered with numerical selections. The minimum easting (MIN E) and the minimum northing (MIN N) are the coordinates at the lower left corner of a map sheet. Each of these coordinates are entered into the MBC preceded by a 0—for example, the grid intersection of a map sheet (lower left corner) is 50/89. The MIN E is entered into the computer as 050, and the MIN N is entered as 089. The three trailing zeros are automatically entered for each display.

DIRECTION ENTRY (DISPLAY-SELECTABLE)

7-12. Select the SEQ switch, and the display shows, "E W GD:___." This display is one example of a direction entry with an amount. East (E) or west (W) must be selected from the display before filling in the underlined blanks for grid declination (GD).

- (1) Locate the GD in the map sheet legend of the area of operations. Before entering the GD, round it off to the nearest 10, and express it in tenths. For example, a GD of 132 is 130; expressed in tenths is 13 (Figure 7-2).

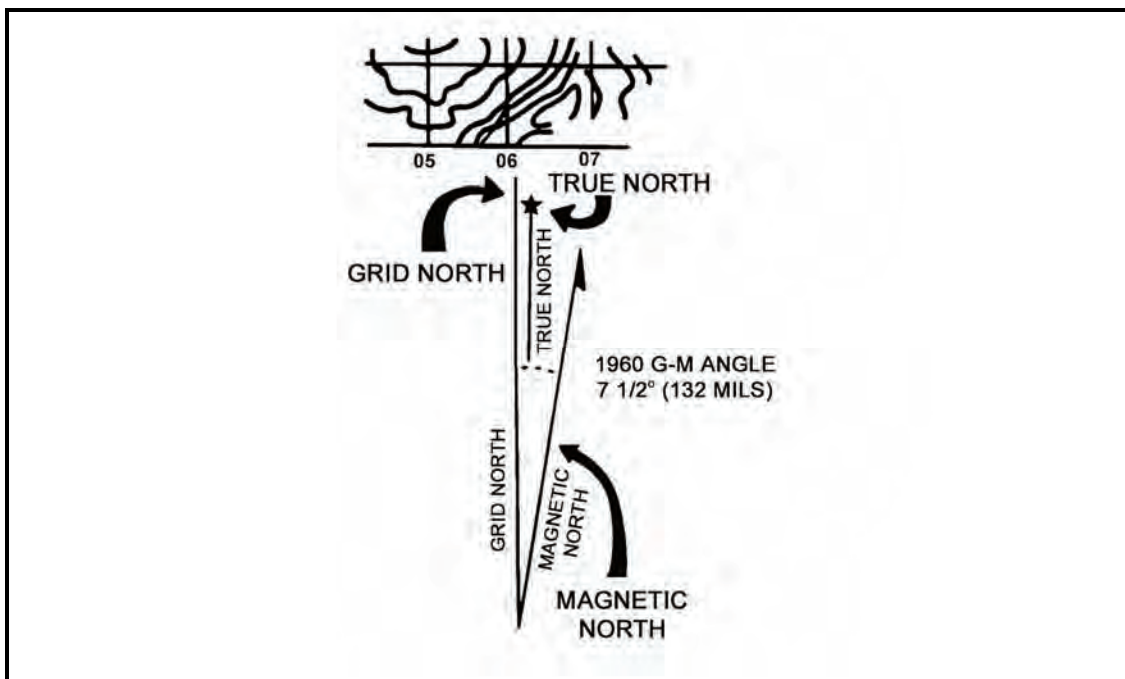

Figure 7-2. Declination diagram.

- (2) Since the GD is easterly, select the display switch beneath the E. The display shows, "E W GD: E _ _." The declination diagram shows the declination in both degrees and mils. Use the mils value given. The difference between grid north and magnetic north is 100 mils, but is entered into the MBC in tens of mils. Press the 1/ABC key once and the 0 key once. The display shows, "E W GD: E 1 0."

NOTE: Additional direction indicators found in other menus are—

H = Horizontal	S = Slant
L = Left	R = Right
U = Up	D = Down
+ = Add	- = Drop
+ = North	- = South

When these symbols appear in later chapters, their meaning will be discussed in depth.

- (3) Select the SEQ switch once to store the grid declination in the computer.

NOTE: Latitude (LAT +/-) comes from a map sheet of an area of operations. Enter plus (+) for the northern hemisphere or minus (-) for the southern hemisphere. The latitude is an optional entry.

MULTIPLE CHOICE ENTRY

7-13. The keytone is the length of time required for a communications device (FM radio) to enable the transmitter before sending data. When a radio is hot from frequent use, it takes a lower keytone to send a message. Similarly, if the radio is cold from the outside temperature, it takes longer to send a message. The normal or default value is 1.4 seconds. For this example, change the keytone to 3.5 seconds as follows:

NOTE: The next three screens are explained in later chapters. Press the SEQ switch four times to advance the display to the keytone menu.

- (1) Press display switch 3 under the flashing cursor. This rejects the default value and gives the first four selections: 0.2 0.7 1.4 2.1. The selection 3.5 is not available on this display. The sequence indicator bulb is flashing to indicate that there are more selections to be viewed.
- (2) Press the SEQ switch again, and the remaining selections appear in the display: 2.8 3.5 4.2 4.8. Press the display switch under 3.5. The display shows, "KEYTONE: 3.5."
- (3) Return to the READY display. Press the SEQ switch twice to advance to the last fill-in-the-blank selection in the SET UP menu. The display shows, "OWN ID: ___." The owner identification code found in the signal operation instructions (SOI) must be entered here, A through Z or 0 through 9. For this example, enter 1. Press the 1/ABC key once. Press display key 4 (under the 1) once. The display now shows, "OWN ID: 1."

NOTE: The FO and FDC must coordinate to ensure that both know the owner's identification when using DMD.

INITIALIZATION

7-14. This paragraph discusses the initialization switches and how they are affected by the different modes of operation.

SELF-TEST

7-15. The MBC can perform its own internal tests. When the operator turns on the MBC or suspects a malfunction, he should initiate the self-test.

NOTE: The test should be performed when time is available.

- (1) Press the ON/OFF switch; the MBC shows, "POWERUP TEST," while performing internal circuit checks, and then it shows, "READY."

NOTE: If any other display appears, turn in the MBC to the sustainment maintenance team. If the BATT LOW indicator flashes or the display does not appear, replace the battery or check the power connections.

- (2) Perform the four self-tests in any sequence. The SELF-TEST switch provides testing of the microprocessor (MICR), all switches and keys (SW), the display and indicators (DSP), and the modem (MOD).
- (3) Press the TEST switch. The software revision number (Revision 3/A) displays.

NOTE: If the correct software revision number is not displayed, turn in the MBC to the sustainment maintenance team.

Microprocessor

- (1) Press the SEQ switch.
- (2) Use the multiple choice entry to select MICR. The test begins.
- (3) Once the test is complete (about 38 seconds), the display shows, " MICR: PASS."

NOTE: If any other display appears, turn in the MBC to the sustainment maintenance team.

Switches and Keys

- (1) Use the multiple choice entry to select SW.
- (2) Press the switch or key indicated in the display.
- (3) When a switch fails or is pressed out of sequence, the display shows, "ERROR." The display returns to the name of the switch to be pressed. If the specified switch is pressed and an error occurs, the switch is inoperative.

NOTE: If the MBC doesn't respond to normal keystrokes, the keyboard assembly may be malfunctioning, and the MBC must be turned in to the sustainment maintenance team.

- (4) After all of the switches and keys have been tested, the display shows, "END OF TEST," and then "READY."

Display

- (1) Use the multiple choice entry to select DSP.
- (2) Press the SEQ switch three times to check for unlit dot segments in each character space.
- (3) During the first part of the display test, make sure all dot segments are lit in the 16-character display.
- (4) In the second part of the test, check for character generation and indicators.

NOTE: Even if one or more dot segments are out, use the MBC if the characters are readable. If the characters are not readable or an indicator is not flashing, turn in the MBC to the sustainment maintenance team.

CAUTION

Do not test the modem while connected to a radio. This could cause internal damage to the MBC.

Modem

- (1) Use the multiple choice entry to select MOD.
- (2) After the modem test (about 20 seconds), the display shows, "MODEM PASS" or "MODEM FAIL."

NOTE: If "MODEM FAIL" shows, message transmission and reception are inoperative. The MBC still accepts manual input data and computes fire missions.

BASIC DATA INPUT

7-16. Before computing a fire mission, the operator must use certain initialization switches to input basic data. Overall MBC initialization is directly related to the tactical scene. Operators must always initialize SET UP, WPN DATA, and AMMO DATA switches, initializing other switches as needed.

Manual Mode

7-17. When the MBC is not connected to an external communication device, all data are manually entered.

Digital Mode

7-18. When the MBC is connected to an external device (DMD-supported), data are digitally entered into the appropriate switch memory. Data entered digitally may be reviewed or supplemented manually.

MINIMUM INITIALIZATION

7-19. Minimum initialization is the least amount of data needed to compute a standard mission. For minimum initialization, operators use the sequence outlined in the following paragraphs.

TEST and BRT Switches

7-20. These switches are used to check overall MBC operation and to set the display brightness.

NOTE: The low setting in the BRT menu lights up the keyboard for night or limited visibility use.

SET UP and WPN DATA Switches

7-21. These two switches must be initialized. They are always manually entered in the MBC. Data will never change due to other switch action; however, the operator may review and update data as needed.

When the AMMO DATA switch default values are suitable, this switch is not needed for initialization. The default values are:

- 60-mm mortar: HE, M720; WP, M302A1; and ILLUM, M83A3.
- 81-mm mortar: HE, M374; WP, M375; ILLUM, M301A3; TNG, M1; and smoke M819 (red phosphorus).
- 120-mm mortar: HE, M933, M934; WP, M929; and ILLUM, M930.
- 120-mm mortar (insert): HE, M374; WP, M375A2; and ILLUM, M301A3.

MINIMUM MISSION DATA

7-22. Once the MBC is turned on and the self-test is conducted, the following minimum Mission Data must be entered to compute for a standard grid mission.

EXAMPLE

SET UP (menu)
Timeout: 60 seconds
Target prefix: AH
Target numbering block: 0001 - 0200
Easting (area of operation): 096000
Northing (area of operation): 029000

NOTE: Precede each easting and northing coordinate with a zero.

(Digital communications data)
Computer owner's identification:
WPN DATA (menu)
Unit: A (section)
Caliber: 120-mm
Carrier-mounted: YES
Basepiece: A2
Basepiece location: E: 0400, N: 4700
Altitude: 0750 meters
Azimuth of fire: 0800 mils

NOTE: If firing a parallel sheaf with all mortars online, the only weapon needed is the basepiece. When the situation allows, enter the rest of the section.

Weapon No. 1: Direction - 1600 mils
Distance - 060 meters
Weapon No. 3: Direction - 4800 mils
Distance - 060 meters
Weapon No. 4: Direction - 4800 mils
Distance - 120 meters

WARNING

Using the default firing data for all guns in the firing section may cause rounds to be fired outside of the safety fan or firing zone. Therefore, always use the technical fire control (TFC) menu when a safety fan or firing zone is used. This gives the MBC operator a warning message to indicate if any rounds will land outside of the safety fan or firing zone. For Revision 3/A, the operator must override the message to continue.

- (1) Press the ON/OFF switch. The display shows, "POWERUP TEST," momentarily, and then shows, "READY."
- (2) Use the TEST switch to manually start the MBC self-test. Perform the self-test as the situation permits or as advised by the supervisor.
- (3) Use the BRT switch to select the level of display character brightness (LOW, MED, HI, or MAX). Use the LOW level to turn on the keyboard background lighting. Character brightness is always set at high when the MBC is turned on or when the BRT switch is pressed.
- (4) Press the SEQ switch. The display shows, "READY." Press the SET UP switch. Use the multiple choice entry to change the timeout to the desired number of seconds (15, 30, 45, or 60).
- (5) Press the SEQ switch. Using alphabetical entry, enter the target prefix, AH.
- (6) Press the SEQ switch. Using numerical entry, enter the target numbering block, 0001 - 9999.
- (7) Press the SEQ switch. Use the default shown (ALARM:OFF). Use the message alarm for DMD-supported missions, if needed.
- (8) Press the SEQ switch. Using numerical entry, enter the minimum easting coordinate, 096.
- (9) Press the SEQ switch. Using numerical entry, enter the minimum northing coordinate, 029.
- (10) Press the SEQ switch until the display shows, "OWN ID: _." "E W GD:," " + - LAT:," "LISTEN ONLY: OFF," "BIT RATE: 1200," "KEYTONE: 1.4," and "BLK: SNG" information may be entered for expanded initialization.
- (11) The final entry in the SET UP menu is the OWN ID. Enter the unit identification code located in the SOI.

Weapon Data

7-23. Use the WPN DATA switch to enter the weapon data for section A, B, and or C. Assign weapons to one, two, or all three sections. A total of 18 weapons may be assigned (six for each section): A1 through A6, B1 through B6, and C1 through C6. The first weapon entered in a section becomes the basepiece. The basepiece is the reference point for the MBC to locate and add weapons to a section.

NOTE: The basepiece does not have to be the number 2 gun or adjusting piece. It is preferable that the basepiece is the centermost gun in the sheaf to ensure balanced fires when firing a parallel sheaf.

- (1) Press the WPN DATA switch. Use the multiple choice entry to select the desired section (A). With the weapon types displayed, select the caliber, 81-/120-mm.
- (2) After the caliber of weapon is selected, the choice of carrier- or ground-mount is next (except for the 60-mm mortar). The MBC defaults to "CARRIER: NO," indicating that the section is to be ground-mounted. Ensure that all weapons in the section are mounted the same. Using the multiple choice entry, select "CARRIER: YES," which indicates that the section is to be carrier-mounted. After entering the selection of carrier-mounted, press the SEQ switch, and the display shows, "CARRIER MV ENTERED." The muzzle velocity is figured differently for ground-

mounted and carrier-mounted mortars; carrier-mounted muzzle velocity corrections for that section are entered into the MBC's memory.

- (3) Press the SEQ switch. Enter the basepiece number using multiple choice entry (A2). The basepiece is a reference for the MBC to locate the other mortars in that section. Time and effort are usually saved if one of the flank mortars is used as the basepiece.
- (4) Press the SEQ switch. Enter the basepiece easting and northing grid coordinates. Most mortar locations are known to within eight-digit grid coordinates. To enter the coordinates, follow these instructions:
 - Given the grid location for the basepiece as 04004700, enter the first four easterly digits by pressing the alphanumeric key for that number, followed with a zero. Press the 0 key. The display shows, "E:0_ _ _ _ N: _ _ _ _ ." Enter the rest of the coordinates. The final display shows, "E:04000 N:47000." Do the same if only a six-digit coordinate is known—for example, "123456" is entered as "12300 45600."

NOTES: 1. Only numbers can be entered; letters are not part of the selection process for grid coordinates.

2. All easting and northing grid coordinates require five-digit entries.

- Press the SEQ switch. Use the multiple choice entry to enter the altitude of the basepiece in meters (0750). The altitude is a mandatory entry. If the FDC does not know the altitude, an entry of 0000 is used. This entry tells the MBC to compute from sea level. Altitude entries may range from 9999 meters to -999 meters.
- Press the SEQ switch. Use a multiple choice entry to enter the direction of fire (azimuth 0800) and referred deflection (2800) in mils.
- Press the SEQ switch, and the display shows, "CONT END." Select Continue (CONT) if the rest of the section is to be entered at this time. If not, select END, and the computer shows, "READY."
- To continue entering weapons, select CONT, and the MBC shows, "WPN:A_ NXT CLR." Enter the weapon number (1) using the 1/ABC alphanumeric key.
- Press the SEQ switch. Use the multiple choice entry to enter weapon direction (1600 mils) and distance (035 meters) from the basepiece.
- Press the SEQ switch. Repeat the steps in the paragraphs above until all guns in the section have been entered. Select END, and the MBC display shows, "READY."

Ammunition Data Default Values

7-24. If the AMMO DATA default values are suitable, the minimum initialization is complete. If suitable, the operator uses the AMMO DATA to select shell types for each ammunition type for the caliber in use. Powder temperature default is 70 degrees and is correctable. When corrections are entered, the word "NO" on the right side of the display is changed to "CR." Weight changes are entered in pounds or squares. When pounds or squares are entered, a conversion is made to show both unit entries.

- (1) Press the AMMO DATA switch. The display shows, "60 81 120 TEMP." Select the caliber of weapon being used by pressing display switch 3 beneath the number.
- (2) The display now shows, "HE: _____ :NO_____." Flashing cursors are on the 2 and the N, which means that the display may be changed. However, the round also comes in different weights as explained earlier. Once the entry has been made by weight in pounds or in squares, press the SEQ switch, and the display shows, "HE: _____ :CR._____."
- (3) Press the SEQ switch. Continue the above procedures until all ammunition requirements are entered.

NOTE: The ammunition menus for all the mortars are similar in format.

EXPANDED INITIALIZATION

7-25. Expanded initialization includes the MET, FIRE ZONES, Forward Observer Location (FO LOC), Known Point/Target (KNPT/TGT), and Registration Data (REG DATA). These data are initialized as they become available.

- Always manually initialize MET when entering nonstandard MET data. If the MET switch is not used, the MBC uses standard conditions for MET data. When the MET is entered, ensure that the SET UP menu has the current data for the grid declination and latitude (LAT).
- Always manually initialize and update FIRE ZONES information, when needed.
- Manually initialize and update FO LOC information when using the manual mode. When the MBC is DMD-supported, input is automatically entered when a valid observer location message is received. This is also a good time to update the SET UP menu. The communication data are "LISTEN ONLY: OFF," "BIT RATE: 1200," "KEYTONE: 1.4," and "BLK:SNG."

NOTE: The bit rate and transmit block mode are located in the SOI.

- Initialize and update KNPT/TGT information at any time, regardless of the mode of operation. The KNPT/TGT switch may be updated automatically using the EOM, REPLOT, and SURV switches, or by receiving digital messages related to the known point/target.
- Manually initialize REG DATA to maintain a registration file when enough data are known from conducting a fire mission. Normally, registration data are generated automatically using the REG switch during fire mission processing, but data manually entered with the REG DATA switch are automatically updated when the REG switch is used to compute registration.

This page intentionally left blank.

Chapter 8

Types of Missions

All fire missions, except FPFs, begin with the GRID, SHIFT, or POLAR switches. The necessary elements of the fire request are entered into the MBC. The WPN/AMMO switch is used to identify the section and the adjusting piece. The firing data are displayed after pressing the COMPUTE switch.

GRID MISSION SWITCH

8-1. The GRID mission switch is used to begin a fire mission when the target is located with grid coordinates. The following paragraphs describe the procedures for conducting a grid mission.

8-2. Press the GRID switch (red) to start the GRID menu. "FR GRID" displays. Press the SEQ switch, and perform the following:

- (1) Enter the FO's call sign in the FO LOC menu (W/12).

NOTE: Entry of the FO's call sign may be omitted.

- (2) Press the SEQ switch.
- (3) Enter MSN:1.
- (4) "TN:AA0001" is displayed, indicating that this is the first mission out of a possible three. The display also shows the target number assigned to this mission by the MBC.
- (5) Press the SEQ switch.
- (6) Enter the OT direction (DIR:0500). If the OT direction is not known, the GT may be selected using display switch 1. When this entry is omitted, the MBC automatically inputs the GT direction.
- (7) Press the SEQ switch.
- (8) Enter the target's grid coordinates (E:06670 N:48832).
- (9) Press the SEQ switch.
- (10) Enter the target's altitude (ALT:0600).
- (11) Press the SEQ switch.
- (12) The Ready light will display.

8-3. Select the WPN/AMMO switch (red), and perform the following:

- (1) Sequence past the following:
 - FO calling in the fire mission (FO:W/12\).
 - Mission and target numbers assigned to the mission (MSN:1 TN:AA0001).
- (2) Enter the adjusting weapon (WP:A2).
- (3) Press the SEQ switch.

NOTE: Once the firing section is selected, the weapon type is displayed along with the adjusting weapon (120mm WPN:A2).

- (4) Review the shell and fuze combination (SH/FZ:HE PD). If other combinations are needed, use display switch 3 for shell changes and display switch 4 for fuze changes.
- (5) Sequence "CHG:" to "READY."

NOTE: The MBC selects the lowest charge possible, or the operator can manually input the charge of his choice.

8-4. Push the COMPUTE switch (green) to receive firing data.

(1) The display "AF STD RP" indicates the following:

- Method of control used.
 - AF = adjust fire.
 - FFE = fire for effect.
- Type of MET.
 - STD = standard.
 - CURR = current.
- Registration point (when used).

(2) Press the SEQ switch.

NOTE: When the COMPUTE switch is pressed before the WPN/AMMO switch, the computer automatically enters the WPN/AMMO menu.

(3) Review the deflection and charge (A2DF:2611 CH:2).

(4) Press the SEQ switch.

(5) Review the fuze setting and elevation (A2FS: EL:1161).

(6) Press the SEQ switch.

NOTE: The fuze setting applies only to the fuzes that require a time setting.

(7) The time of flight is displayed (A2 TOF:40.0).

(8) Press the SEQ switch.

(9) "READY" is displayed.

8-5. Push the SFTY DATA switch (orange) to receive safety information.

(1) The display, "RN:3238 AZ:0987," indicates the following:

- Range from the gun position to the target.
 - Azimuth from the gun position to the target.
-

NOTE: At this point, it is not necessary to continue in the SFTY DATA menu.

(2) Press the BACK switch (green) to "READY."

8-6. Push the XMIT switch (green) to receive or format messages to the observer.

(1) Press display switch 1 under "MTO" (MSN:1). The target number displays (TN:AA0001).

NOTE: In most cases, angle T information is the only concern.

(2) Press the SEQ switch 11 times to receive the angle T. The angle T displays (ANG T:0200MILS).

(3) To exit out of this menu, press the MSN switch (light green), and then press the BACK switch.

(4) "READY" is displayed.

- 8-7. Wait for FO adjustments (if any). To make FO adjustments—
- (1) Press the ADJ switch (red).
 - (2) "ADJ MPI" is displayed.
 - (3) Press display switch 1 under the ADJ switch.
 - (4) "ENT REV" is displayed.
 - (5) To enter adjustments, select ENT. To review the last adjustment, select REV.
 - (6) Press display switch 1, "ENT."
 - (7) "ADJUST FO:W/12\" is displayed.
 - (8) Press the SEQ switch.
 - (9) The mission and target numbers assigned to the mission display (MSN:1 TN:AA0001).
 - (10) Press the SEQ switch.
 - (11) Current registration and MET data display (REG/MET: NO, no current registration or MET data apply to this mission).
 - (12) Press the SEQ switch.
 - (13) The type of MET displays (MET:STD - MET to be applied to this mission will be standard).
 - (14) Press the SEQ switch.
 - (15) The FO's direction to the target is displayed (GT DIR:0987).
 - (16) Press the SEQ switch.
 - (17) "L R DEV" is displayed.

NOTE: During the initial input of the mission, the MBC operator bypasses the direction entry. The direction shown is the GT direction, also known as the initial azimuth. At this point, the MBC operator ensures that the FO's direction is shown. To clear the portion of the display showing the direction, press display switch 3 under the flashing display cursor, or press the CLEAR ENTRY switch once to clear a digit at a time. Once the GT azimuth is cleared, the FO's direction (0500) may be inserted.

- (18) Enter the lateral deviation adjustment (if any) by selecting the corresponding display switch under the deviation direction letter. Follow the entry with the number of meters to deviate in lateral adjustment (R0050).
 - (19) Press the SEQ switch.
 - (20) "+ - RN:" is displayed.
 - (21) Enter the range adjustment (if any) by selecting the corresponding display switch under the range adjustment letter. Follow the entry with the number of meters to adjust in range (-0050).
 - (22) Press the SEQ switch.
 - (23) "HGT: MTR" is displayed.
 - (24) Enter the height adjustment that applies. Height entries are in meters. This can be changed to feet by pressing display switch 2 and selecting "FT" (display switch 2).
 - (25) Press the SEQ switch.
 - (26) "U D HT:" is displayed.
 - (27) Enter the altitude adjustment (if any) by selecting the corresponding display switch under the height adjustment letter. Follow the entry with the number of meters (or feet) to adjust in height.
- 8-8. Push the COMPUTE switch (green) to receive firing data.
- (1) The method of control used, type of MET, and RP (when used) display (AF STD RP).
 - (2) Press the SEQ switch.
 - (3) The deflection and charge display (A2DF:2589 CH:2).
 - (4) Press the SEQ switch.
 - (5) The fuze setting and elevation display (A2FS: . EL:1165).
 - (6) Press the SEQ switch.

- (7) The time of flight is displayed (A2 TOF:40.1).
- (8) Press the SEQ switch.
- (9) "READY" is displayed.

8-9. Once all adjustments have been made or the FO requests FFE, decide how to engage the target. Based on the information given by the FO in the CFF, use the TFC key.

8-10. Press the TFC switch (red), and conduct the following procedures:

- (1) The call sign of the FO calling in the fire mission displays (TFC FO:W/12(-)).
- (2) Press the SEQ switch.
- (3) The mission and target numbers assigned to the mission display (MSN:1 TN:AA0001).
- (4) Press the SEQ switch.
- (5) The sheaf type preferred by the FDC for this mission displays (SHEAF:PRL).

NOTE: The preferred sheaf type can be changed when necessary.

- (6) Press the SEQ switch.
- (7) The method of control displays (CON:AF).

NOTE: The method of control can be changed when necessary.

- (8) Enter FFE.
- (9) Press the SEQ switch.
- (10) The section and the weapons assigned to the FFE display (GUNS:A2 13).

NOTE: The section and the weapons assigned to the FFE can be changed when necessary.

- (11) Press the SEQ switch.
- (12) Current registration or MET data that apply to this mission display (REG/MET:NO - no current registration or MET data apply to this mission).

NOTE: Current registration or MET data that apply to this mission can be changed when necessary.

- (13) Press the SEQ switch.
- (14) The type of MET displays (MET:STD - MET to be applied to this mission will be standard).

NOTE: The type of MET can be changed when necessary.

- (15) Press the SEQ switch.
- (16) "PUSH COMPUTE" is displayed.

8-11. Press the COMPUTE switch (green) to receive firing data. Press the SEQ switch to receive firing data for each gun.

NOTE: Once EOM is received, use the SFTY DATA switch to obtain the burst point coordinates (06691 48764).

8-12. Press the EOM switch (green) to end the mission.

- EOM ends the mission without saving.
- EOMRAT ends the mission and records it as a target or known point.

NOTE: The flashing red light over the SEQ switch indicates that additional information is available for the current menu or display.

- EOMFPF ends the mission and records it as an FPF.

8-13. Press EOM (green key), then EOMRAT. Sequence and save the mission as known point 00. Sequence to "READY."

SHIFT MISSION SWITCH

8-14. The SHIFT mission switch is used to initiate a fire request that uses the shift from a known point method of target location. The following paragraphs describe the procedures for conducting a shift from a known point mission.

8-15. Press the SHIFT switch. "FR SHIFT" is displayed. Press the SEQ switch.

- (1) "FO:/00\-" is displayed.
- (2) Enter the FO call sign (W12).
- (3) Press the SEQ switch.
- (4) "FROM:TGT KNPT" is displayed.
- (5) Select a target or known point to shift from (ENTER KP00).
- (6) Press the SEQ switch.
- (7) "GT DIR:" is displayed.
- (8) Enter the direction from the CFF (DIR 0500).
- (9) Press the SEQ switch.
- (10) The mission and target numbers assigned to the mission display (MSN:* TN:*****, * denotes the target number assigned by the MBC).
- (11) Press the SEQ switch.
- (12) "L R DEV" is displayed.
- (13) Enter the lateral deviation correction that applies (L0500).
- (14) Press the SEQ switch.
- (15) "+ - RN:" is displayed.
- (16) Enter the range correction that applies (-0100).
- (17) Press the SEQ switch.
- (18) "U D HGT:" is displayed.
- (19) Enter the altitude correction that applies (U100).
- (20) Press the SEQ switch.
- (21) "READY" is displayed.

8-16. Press the WPN/AMMO switch. "WPN/AMMO" is displayed. Press the SEQ switch.

- (1) The call sign of the FO calling in the fire mission displays (FO:*/**\(-).
- (2) Press the SEQ switch.
- (3) The mission and target numbers assigned to the mission display (MSN:* TN:*****, *).
- (4) Press the SEQ switch.
- (5) "WPN:" is displayed.
- (6) Enter the adjusting weapon (WPN:A2).
- (7) Press the SEQ switch.
- (8) The shell and fuze combination displays (SH/FZ: HE PD).

- (9) Change the shell and fuze combination, if needed.
 - (10) Sequence past "CHG:" to "READY."
- 8-17. Push the COMPUTE switch to receive firing data.
- (1) Sequence past "AF STD RP."
 - (2) Review the deflection and charge (A2DF:2725 CH:2).
 - (3) Press the SEQ switch.
 - (4) Review the fuze setting and elevation (A2FS: . EL:1212).
 - (5) Press the SEQ switch.
 - (6) The time of flight is displayed (A2 TOF:40.3).
 - (7) Press the SEQ switch.
 - (8) "READY" is displayed.
- 8-18. Push the SFTY DATA switch to receive safety information.
- (1) Review the range and azimuth (RN:2916 AZ:0872).
 - (2) Press the BACK switch to "READY."
- 8-19. Push the XMIT switch to receive or format the message to the observer.
- (1) Press display switch 1 under "MTO."
 - (2) Press the SEQ switch 11 times to receive the angle T (ANG T:0200 mils).
 - (3) To exit this menu, press the MSN switch (light green), and then press the BACK switch.
 - (4) "READY" is displayed.
- 8-20. Wait for FO adjustments (if any). To make these adjustments—
- (1) Press the ADJ switch.
 - (2) "ADJ MPI" is displayed.
 - (3) Press display switch 1 under "ADJ."
 - (4) "ENT REV" is displayed.
 - (5) Press display switch 1.
 - (6) "ENT" is displayed.
 - (7) Sequence to GT.
 - (8) The FO's direction to the target displays (DIR:****).
 - (9) Press the SEQ switch.
 - (10) "L R DEV" is displayed.
 - (11) Enter the lateral deviation correction that applies (L0050).
 - (12) Press the SEQ switch.
 - (13) "+ - RN:" is displayed.
 - (14) Enter the range correction that applies (+0050).
 - (15) Press the SEQ switch.
 - (16) The height entry is displayed (HGT:MTR).
 - (17) Press the SEQ switch.
-
- NOTE:** Height entries appear in meters, but can be changed to feet by pressing display switch 2 and selecting "FT" (display switch 2).
-
- (18) "U D HT:" is displayed.
 - (19) Enter the altitude adjustment (D0050).
 - (20) Press the SEQ switch.
 - (21) "READY" is displayed.

8-21. Push the COMPUTE switch to receive firing data, and then follow these procedures:

- (1) Sequence past "AF STD RP."
- (2) Review the deflection and charge (A2DF:2748 CH:2).
- (3) Press the SEQ switch.
- (4) Review the fuze setting and elevation (A2FS . EL:1209).
- (5) Press the SEQ switch.
- (6) The time of flight is displayed (A2 TOF:40.5).
- (7) Press the SEQ switch.
- (8) "READY" is displayed.

8-22. Once all adjustments have been made or the FO requests FFE, decide how to engage the target. Based on the information given by the FO in the CFF, press the TFC switch, and follow these procedures:

- (1) The call sign of the FO calling in the fire mission displays (TFC FO:*/**\(-).
- (2) Press the SEQ switch.
- (3) The mission and the target numbers assigned to the mission display (MSN:* TN:*****).
- (4) Press the SEQ switch.
- (5) The sheaf type preferred by the FDC for this mission displays (SHEAF:PRL).

NOTE: The preferred sheaf type can be changed when necessary.

- (6) Press the SEQ switch.
- (7) The method of control displays (CON:AF).

NOTE: The method of control can be changed when necessary.

- (8) Enter FFE.
- (9) Press the SEQ switch.
- (10) The section and the weapons assigned to the FFE display (GUNS:A2 13).

NOTE: The section and the weapons assigned to the FFE can be changed when necessary.

- (11) Press the SEQ switch.
- (12) Current registration or MET data that apply to this mission display (REG/MET:NO - no current registration or MET data apply to this mission).

NOTE: Current registration or MET data that apply to this mission can be changed when necessary.

- (13) Press the SEQ switch.
- (17) The type of MET displays (MET:STD - MET to be applied to this mission will be standard).

NOTE: The type of MET can be changed when necessary.

- (14) "PUSH COMPUTE" is displayed.

8-23. Press the COMPUTE switch to receive firing data. Then, press the SEQ switch to receive the firing data for each gun.

- 8-24. Press the EOM switch (green) to end the mission.
- EOM ends the mission without saving.
 - EOMRAT ends the mission and records it as a target or known point.
-

NOTE: The flashing red light over the SEQ switch indicates that additional information is available for the current menu or display.

- EOMFPF ends the mission and records it as an FPF.

- 8-25. Press EOM, then EOMRAT. Sequence and save the mission as known point 01. Now, sequence to "READY."

POLAR MISSION SWITCH

- 8-26. The POLAR switch is used to initialize a mission that uses the polar plot method of target location. The following paragraphs describe the procedures for conducting a polar plot mission.

- 8-27. Press the POLAR switch.
- (1) "NORMAL LASER" is displayed.
 - (2) Select "NORMAL."
-

NOTE: The FO conducts this mission in the normal mode. NORMAL is a method of target location using a map or any nonlaser device. LASER is a method of target location using laser equipment.

- (3) "FR POLAR" is displayed.
 - (4) Press the SEQ switch.
 - (5) "FO:/00\" is displayed.
 - (6) Enter the FO's call sign (W/12).
 - (7) Press the SEQ switch.
 - (8) The mission and target numbers assigned by the MBC display (MSN:* TN:*****, * denotes the target number).
 - (9) Press the SEQ switch.
 - (10) "DIR:" is displayed.
 - (11) Enter the direction from the CFF (DIR:0800).
 - (12) Press the SEQ switch.
 - (13) "DIS:" is displayed.
 - (14) Enter the distance from the CFF (DIS:2000).
 - (15) Press the SEQ switch.
 - (16) "U D HGT:" is displayed.
 - (17) Enter the altitude correction that will be applied (D050).
 - (18) Press the SEQ switch.
 - (19) "READY" is displayed.
- 8-28. Press the WPN/AMMO switch.
- (1) "WPN/AMMO" is displayed.
 - (2) Press the SEQ switch.
 - (3) The FO's call sign entered in step 1 displays (FO:*/**\-, * denotes the FO's call sign).
 - (4) Press the SEQ switch.
 - (5) The mission and target numbers assigned by the MBC display (MSN:* TN:*****, * denotes the target number).

- (6) Enter the adjusting weapon (WPN:A2).
 - (7) Press the SEQ switch.
 - (8) The shell and fuze combination displays (SH/FZ: HE PD).
 - (9) Change the shell and fuze combination, if needed.
 - (10) Press the SEQ switch.
 - (11) "CHG:" displays. The operator can manually set the charge.
 - (12) Press the SEQ switch.
 - (13) "READY" displays.
- 8-29. Push the COMPUTE switch to receive firing data.
- (1) Sequence past "AF STD RP."
 - (2) Review the deflection and the charge (A2DF:2452 CH:1).
 - (3) Press the SEQ switch.
 - (4) Review the fuze setting and elevation (A2FS. EL:1139).
 - (5) Press the SEQ switch.
 - (6) The time of flight is displayed (A2 TOF:31.5).
 - (7) Press the SEQ switch.
 - (8) "READY" is displayed.
- 8-30. Push the SFTY DATA switch to receive safety information.
- (1) Review the range and azimuth (RN:2121 AZ:1146).
 - (2) Press the BACK switch to "READY."
- 8-31. Push the XMIT switch to receive and format messages to the observer by performing these procedures:
- (1) Press display switch 1 under "MTO."
 - (2) Press the SEQ switch 11 times to receive the angle T (ANG T:0300 MILS).
 - (3) To exit out of the menu, press the MSN switch (light green), and then press the BACK switch. "READY" is displayed.
- 8-32. Wait for FO adjustments (if any). To make adjustments—
- (1) Press the ADJ switch.
 - (2) "ADJ MIP" is displayed.
 - (3) Press display switch 1 under "ADJ."
 - (4) "ENT REV" is displayed.
 - (5) Press display switch 1, "ENT."
 - (6) Sequence to the FO's direction to the target (GT DIR:****).
 - (7) Press the SEQ switch.
 - (8) "L R DEV" is displayed.
 - (9) Enter the lateral deviation correction that applies (L0050).
 - (10) Press the SEQ switch.
 - (11) "+ - RN" is displayed.
 - (12) Enter the range correction that applies (+0025).
 - (13) Press the SEQ switch.
 - (14) "U D HT" is displayed.
 - (15) Enter the altitude correction that applies.
 - (16) Press the SEQ switch.
 - (17) "READY" is displayed.

8-33. Push the COMPUTE switch to receive firing data.

- (1) Sequence past "AF STD RP."
- (2) Review the deflection and charge (A2DF:2479 CH:1).
- (3) Press the SEQ switch.
- (4) Review the fuze setting and elevation (A2FS: . EL:1138).
- (5) Press the SEQ switch.
- (6) The time of flight is displayed (AZ TOF:31.5).
- (7) Press the SEQ switch.
- (8) "READY" is displayed.

8-34. Once all adjustments have been made or the FO requests an FFE, decide how to engage the target. Based on the information given by the FO in the CFF, use the TFC key.

- (1) Press the TFC key.
- (2) The FO calling in the fire mission displays (TFC FO:*/**\~).
- (3) Press the SEQ switch.
- (4) The mission and target numbers assigned to the mission display (MSN:* TN:*****).
- (5) Press the SEQ switch.
- (6) The sheaf type preferred by the FDC for this mission displays (SHEAF:PRL).

NOTE: The preferred sheaf type can be changed when necessary.

- (7) Press the SEQ switch.
- (8) The method of control displays (CON:AF).

NOTE: The method of control can be changed when necessary.

- (9) Enter FFE.
- (10) Press the SEQ switch.
- (11) The section and the weapons assigned to the FFE display (GUNS:A2 13).

NOTE: The section and the weapons assigned to the FFE can be changed when necessary.

- (12) Press the SEQ switch.
- (13) Current registration or MET data that apply to this mission display (REG/MET:NO - no current registration or MET data apply to this mission).

NOTE: Current registration or MET data that apply to this mission can be changed when necessary.

- (14) Press the SEQ switch.
- (15) The type of MET displays (MET:STD - MET to be applied to this mission will be standard).

NOTE: The type of MET can be changed when necessary.

- (16) "PUSH COMPUTE" is displayed.

- 8-35. Press COMPUTE to receive firing data.
- (1) Press the SEQ switch.
 - (2) Firing data for each gun is displayed.
-

NOTE: Once EOM is received, the MBC operator uses the SFTY DATA switch to obtain the burst point coordinates.

- 8-36. Press the EOM switch (green) to end the mission.
- EOM ends the mission without saving.
 - EOMRAT ends the mission and records it as a target or known point.
-

NOTE: The flashing red light over the SEQ switch indicates that additional information is available for the current menu or display.

- EOMFPF ends the mission and records it as an FPF.

- 8-37. Press EOM (green key), and then "EOM 1," the display switch under EOM.

TECHNICAL FIRE CONTROL

8-38. Based on information given in the CFF, the FDC chief/section leader decides how best to engage the target. Once the FO enters the FFE phase, the MBC operator can use the technical fire control (TFC) switch to engage the target (as directed by the FDC order).

8-39. The TFC control menu allows the FDC to enter or change information for the following default values:

- Sheaf: Parallel.
- Method of control: Adjust fire.
- Weapons to fire: Basepiece selected.
- Registration data: No.
- MET data: Standard.

8-40. When all of the defaults are acceptable, the TFC switch is not needed. Table 8-1 provides a brief description of the TFC menu abbreviations and their uses.

NOTE: Always use the TFC switch when using a safety fan or fire zones.

Table 8-1. TFC menu abbreviations and their uses.

ABBREVIATIONS	USES
SHEAF:PRL	<p>The type of sheaf needed to engage the target</p> <p>Selections include—</p> <ul style="list-style-type: none"> • PRL (parallel). • CVG (converge). • SPECIAL.
CON:AF: CON	<p>Means of controlling fires</p> <p>Selections include—</p> <ul style="list-style-type: none"> • AF (adjust fire). • FFE (fire for effect). • DST (destruction). • REG (registration). <p>NOTE: In the adjust fire mode, only the weapon selected through the WPN AMMO switch is shown. When the operator enters FFE, all assigned available weapons in that section are included in the computation of fire data. When control is FFE or DST, some weapons (not the adjusting weapon) may be deleted by using a correction entry.</p>
GUNS	<p>Mortars available for the designated control of fires</p> <p>For example, if AF appears on the previous screen, the only mortar shown on this display is the piece designated by the MBC operator in the WPN/AMMO menu.</p>
REG/MET	<p>If a MET has been entered and made current, this display would show REG/MET: YES. This tells the operator that MET or registration corrections will be applied to the target firing data.</p> <p>If the display shows REG/MET: NO, no corrections are applied.</p>
MET:STD	<p>Type of MET corrections used for the fire mission</p> <p>Selections include STD (standard) and CURR (current).</p>

SHEAVES

8-41. The term sheaf denotes the lateral distribution of the bursts of two or more weapons firing at the same target at the same time. The distribution of bursts is the pattern of bursts in the area of the target. Normally, all weapons of the platoon or section fire with the same deflection, charge, and elevation. However, since targets may be various shapes and sizes and the weapons may be deployed irregularly, it is best to adjust the pattern of bursts to the shape and size of the target.

8-42. Individual weapon corrections for deflection, charge, and elevation are computed and applied to obtain a specific pattern of bursts. These corrections, called special corrections, are computed and applied based on the target's attitude, width, length, and adjusting point.

8-43. When the mortar section or platoon engages a target, different sheaves can be used. The types of sheaves include—

- Parallel.
- Converged.
- Open.
- Linear (standard).
- Special.

NOTE: See Chapter 4 for more information.

PARALLEL SHEAF

8-44. When mortars fire a parallel sheaf, the distance between impacts of rounds is the same as the distance between mortars. The mortars all fire using the same firing data. Parallel sheaves are normally used on area targets.

CONVERGED SHEAF

8-45. When mortars fire a converged sheaf, rounds from two or more mortars impact on the same point in the target area. This sheaf is normally used on point targets, such as bunkers or machine gun positions.

OPEN SHEAF

8-46. When mortars fire an open sheaf, the distance between impacts of rounds is half the distance between mortars. Normally, 120-mm mortars are positioned 60 to 75 meters apart, and 81-mm are positioned 35 to 40 meters apart; thus, in an open sheaf, rounds should land about 60 meters apart. For 60-mm mortars, which are normally positioned 25 to 30 meters apart, rounds should land about 45 meters apart. All mortars fire using different deflections. Open sheaves are used when the target is slightly wider than the area a linear sheaf would cover.

LINEAR (STANDARD) SHEAF

8-47. When mortars fire a linear sheaf, rounds impact within the total effective width of the bursts, regardless of the mortar locations.

SPECIAL SHEAF

8-48. When mortars fire a special sheaf, each mortar has a certain point to engage. The mortars may have different deflections, charges, and elevations. This sheaf is normally used in an attitude mission.

NOTE: When mortars fire an open or linear sheaf, the operator must use the special sheaf function and enter the appropriate data to obtain the desired results.

TRAVERSING FIRE

8-49. Mortars use traversing fire when the target is wider than the area a standard or open sheaf would cover. They engage wide targets using a distributed FFE. Each mortar of the section covers a portion of the total target area and traverses the area. The mortars are manipulated for deflection between rounds until the number of rounds given in the fire command has been fired.

-
- NOTES:**
1. The target's attitude should be within 100 mils of the mortar section's attitude (WPN DATA menu).
 2. The target's attitude should be perpendicular to the gun's direction of fire. When firing at targets using anything other than perpendicular angles, a combination of traverse and search will result.
-

8-50. Upon receiving the CFF, the section leader/chief computer determines from the size and description of the target that (in this example) traversing fire will be used to cover the target. He then issues the FDC order (Figure 8-1).

NOTE: Distribution of mortar fire to cover area targets (depth or width) is computed at one round for each 30 meters and four rounds for each 100 meters for 81-mm mortars, and one round for each 60 meters and 2 rounds for each 100 meters for 120-mm mortars.

COMPUTER'S RECORD			
For use of this form, see FM 3-22.81, the proponent agency is TRADOC			
ORGANIZATION <i>B Co 1/29 IN</i>	DATE	TIME	OBSERVER ID <i>D61</i>
TARGET NUMBER <i>CA0701</i>			
<input checked="" type="checkbox"/> ADJUST FIRE <input type="checkbox"/> FIRE FOR EFFECT <input type="checkbox"/> IMMEDIATE SUPPRESSION	SHIFT FROM _____	POLAR OT DIRECTION _____ ALTITUDE _____	
GRID <i>038 629</i> OT DIRECTION <i>2400</i> ALTITUDE <i>420</i>	OT DIRECTION _____ ALTITUDE _____ <input type="checkbox"/> LEFT / <input type="checkbox"/> RIGHT <input type="checkbox"/> ADD / <input type="checkbox"/> DROP <input type="checkbox"/> UP / <input type="checkbox"/> DOWN	DISTANCE _____ <input type="checkbox"/> UP / <input type="checkbox"/> DOWN VERTICAL ANGLE <input type="checkbox"/> + / <input type="checkbox"/> -	
TARGET DESCRIPTION <i>Co IN OPEN 250 X 50 AT 0720</i>		METHOD OF CONTROL	
METHOD OF ENGAGEMENT		MESSAGE TO OBSERVER	
FDC ORDER	INITIAL CHART DATA	INITIAL FIRE COMMAND	ROUNDS EXPENDED
MORTART TO FFE <i>SEC</i>	DEFLECTION _____	MORTAR TO FOLLOW _____	
MORTAR TO ADJ <i>#2</i>	DEFLECTION CORRECTION <input type="checkbox"/> L <input type="checkbox"/> R	SHELL AND FUZE _____	
METHOD OF ADJ <i>1 RD</i>	RANGE _____	MORTAR TO FIRE _____	
BASIS FOR CORRECTION _____	VIALT CORRECTION <input type="checkbox"/> + <input type="checkbox"/> -	METHOD OF FIRE _____	
SHEAF CORRECTION <i>OPEN</i>	RANGE CORRECTION <input type="checkbox"/> + <input type="checkbox"/> -	DEFLECTION _____	
SHELL AND FUZE <i>HEQ IN ADJ</i>	CHARGE/RANGE _____	CHARGE _____	
<i>PROX IN FFE</i>	AZIMUTH _____	TIME SETTING _____	
METHOD OF FFE <i>3RDS</i>	ANGLE T _____	ELEVATION _____	
RANGE LATERAL SPREAD _____			
ZONE _____			
TIME OF OPENING FIRE <i>W/R</i>			

Figure 8-1. Excerpt from example DA Form 2399-R (Computer's Record) with call for fire and FDC order completed.

8-51. When using the information in the CFF, FDC order, and FO corrections, the FDC computes the data to adjust the base mortar (usually the No. 2 mortar) onto the center of mass for the target area. He computes the firing data to the center of mass. The FDC selects the SFTY DATA switch and records the range and burst point grid coordinates on DA Form 2399-R (Figure 8-2).

COMPUTER'S RECORD												
For use of this form, see FM 3-22.91; the proponent agency is TRADOC												
ORGANIZATION <u>B Co 1st IN</u>				DATE		TIME		OBSERVER ID <u>D61</u>		TARGET NUMBER <u>CA 0701</u>		
<input type="checkbox"/> ADJUST FIRE <input type="checkbox"/> FIRE FOR EFFECT <input type="checkbox"/> IMMEDIATE SUPPRESSION				SHIFT FROM _____				POLAR				
GRID <u>038 629</u>				DT DIRECTION _____ ALTITUDE _____				DT DIRECTION _____ ALTITUDE _____				
DT DIRECTION <u>2400</u>				<input type="checkbox"/> LEFT / <input type="checkbox"/> RIGHT <input type="checkbox"/> ADD / <input type="checkbox"/> DROP <input type="checkbox"/> UP / <input type="checkbox"/> DOWN				DISTANCE _____				
ALTITUDE <u>420</u>								VERTICAL ANGLE <input type="checkbox"/> +1 <input type="checkbox"/> -				
TARGET DESCRIPTION <u>CO IN OPEN 250X50 ATT 0720</u>						METHOD OF CONTROL						
METHOD OF ENGAGEMENT						MESSAGE TO OBSERVER						
FDC ORDER				INITIAL CHART DATA				INITIAL FIRE COMMAND				ROUNDS EXPENDED
MORTAR TO FFE <u>SEC</u>				DEFLECTION <u>0918</u>				MORTAR TO FOLLOW <u>SEC</u>				① HE
MORTAR TO ADJ <u>#2</u>				DEFLECTION CORRECTION <input type="checkbox"/> L <input type="checkbox"/> R				SHELL AND FUZE <u>HEQ</u>				
METHOD OF ADJ <u>IRD</u>				RANGE _____				MORTAR TO FIRE <u>#2</u>				
BASIS FOR CORRECTION _____				VIALT CORRECTION <input checked="" type="checkbox"/> . <input type="checkbox"/> - <u>20</u>				METHOD OF FIRE <u>IRD</u>				
SHEAF CORRECTION <u>OPEN</u>				RANGE CORRECTION <input type="checkbox"/> . <input type="checkbox"/> - <u>0</u>				<u>3RDS PROX IN FFE</u>				
SHELL AND FUZE <u>HEQ IN ADJ</u>				CHARGE/RANGE <u>5</u>				DEFLECTION/AZIMUTH <u>0918</u>				
<u>PRDX IN FFE</u>				AZIMUTH <u>2320</u>				CHARGE <u>5</u>				
METHOD OF FFE <u>3RDS</u>				ANGLE T <u>80</u>				TIME SETTING _____				
RANGE LATERAL SPREAD _____								ELEVATION <u>0963</u>				
TIME OF OPENING FIRE <u>W/R</u>												
OBSERVER CORRECTION			CHART DATA			SUBSEQUENT COMMANDS						
DEV	RANGE	TIME (HEIGHT)	DEFL	CHARGE (RANGE)	MORTAR FIRE	METHOD FIRE	DEFL AZIMUTH	RANGE	CHARGE	TIME (SETTING)	ELEV	
<u>L120</u>							<u>0960</u>	<u>2750</u>		<u>0963</u>	① HE	
	<u>-100</u>						<u>0962</u>	<u>2650</u>			② HE	
	<u>-50</u>	<u>FFE</u>			<u>SEC</u>	<u>3RDS PROX</u>	<u>0957</u>					
							<u>0963</u>	<u>2600</u>			③ PROX	
							<u>0975</u>					

DA FORM 2399-R, FEB 2005 REPLACES DA FORM 2399, DEC 91 WHICH IS OBSOLETE AFD V1.00

Figure 8-2. Example of completed DA Form 2399-R (Computer's Record) for adjustment.

8-52. After the adjustment is complete, the FDC must perform the following procedures:

- (1) Divide the target into equal segments by dividing the target's width by the number of mortars in the FFE.

EXAMPLE

Target's width = 300 meters
 Number of mortars in the FFE = 3
 $300/3 = 100$ meters each mortar has to cover

- (2) Determine and apply the modification (either +/- range correction or left/right deviation correction). Divide the segment width by 2 to determine the appropriate modification. For example, $100/2 = 50$. Use one of the following methods to apply the modification.
 - Use Table 8-2 to determine the direction (plus or minus) for the modification.

Table 8-2. Gun-target azimuth chart.

GUN-TARGET AZIMUTH 4901-1499	
TRAVERSE LEFT (+)	
TRAVERSE RIGHT (-)	
GUN-TARGET AZIMUTH 1500-1700	
ATTITUDE < 1600	ATTITUDE > 1600
TRAVERSE LEFT (-)	TRAVERSE LEFT (+)
TRAVERSE RIGHT (+)	TRAVERSE RIGHT (-)
GUN-TARGET AZIMUTH 1701-4699	
TRAVERSE LEFT (-)	
TRAVERSE RIGHT (+)	
GUN-TARGET AZIMUTH 4700-4900	
ATTITUDE < 1600	ATTITUDE > 1600
TRAVERSE LEFT (+)	TRAVERSE LEFT (-)
TRAVERSE RIGHT (-)	TRAVERSE RIGHT (+)

EXAMPLE

Consider a GT of 5300 mils, traverse right. Since the GT azimuth falls in the azimuth block of 4901-1499, the modification will be a plus if traversing left and a minus if traversing right. Since the mortars will traverse right, their modification will be -50.

OR

- When the FDC finds itself without the GT azimuth chart, personnel need an alternative method of computing the modification. Therefore, draw the situation to help new FDC personnel understand how and why the MBC computes the traverse data.

EXAMPLE (Figures 8-3 through 8-5)

Target = 300 x 50 meters
 Attitude (TGT) = 0400 mils
 GT azimuth (DOF) = 5300 mils
 Three-mortar section

Guns must be placed so they are using the direction of the target's attitude (400 mils). The FDC determines if it needs a plus or minus correction to get to the starting point.

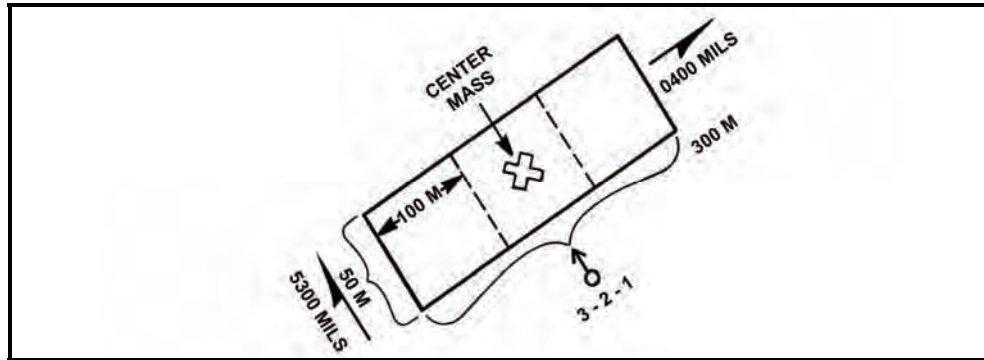

Figure 8-3. Example situation chart number 1.

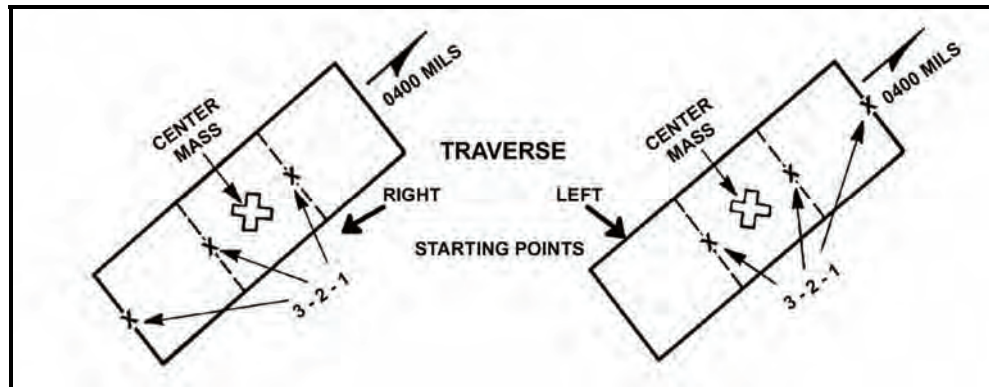

Figure 8-4. Example situation charts numbers 2 and 3.

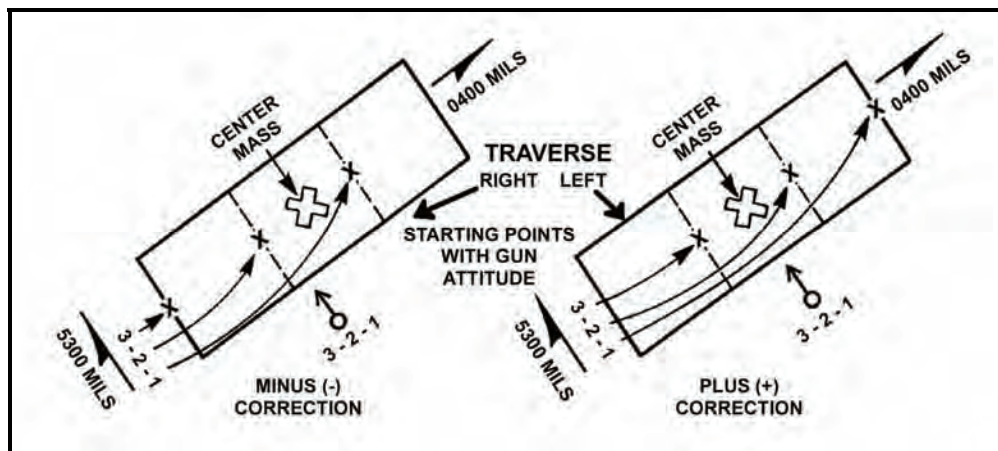

Figure 8-5. Example situation charts numbers 4 and 5.

OR

- Use the following procedure:
 - (1) Determine the perpendicular to the attitude (add or subtract 1600 mils; use whichever is closer to the final azimuth of fire), and apply the modification as a left or right correction. When computing for firing data using the perpendicular, copy the range and burst point grid coordinates, and the final azimuth of fire.
 - (2) Add or subtract 1600 mils from the target's attitude. Use the answer that comes closest to the final azimuth of fire for the direction correction in the ADJ menu.
 - (3) Select the ADJ switch, and change the direction to the perpendicular azimuth.
 - (4) Make a deviation correction instead of making a range correction (as in previous examples). This correction is one-half the distance each mortar must cover.
 - (5) Enter a right deviation correction if traversing left; enter a left deviation correction if traversing right.
- (3) Once the modification has been entered into the ADJ menu of the MBC, press the TFC switch, and change or enter the following data:
 - Change SHEAF:PRL to read SHEAF:SPECIAL.
 - Change ADJ PT:FLANK to read ADJ PT:CENTER.
 - Enter the target's width (total area to be covered in the CFF), such as 300 x 50 meters.
 - Enter target's attitude, such as 400 mils.
 - Change CON:AF to read CON:FFE.
 - Press the COMPUTE switch and receive firing data.
- (4) Determine the number of rounds for each segment.

EXAMPLE

Assume that the target is 350 meters wide.

- (1) Divide the area into equal segments: $350/3 = 116$. Each mortar covers 116 meters of the target area.
 - (2) Determine the number of rounds needed to cover one segment: 4 rounds (for 100 meters) + 1 round (for the remaining 16 meters) = 5 rounds per segment.
-

- (5) Determine the mil width of one segment; the other segments are the same. Use one of two methods to determine the number of mils for one segment:
 - In the first method, the start point deflections for all the mortars are given. Compare the mil difference between either No. 1 mortar and No. 2 mortar or No. 2 mortar and No. 3 mortar (or No. 3 mortar and No. 4 mortar, if available). For example, No. 1 mortar has a deflection of 2719 mils, and No. 2 mortar has a deflection of 2773 mils. The mil difference is 54 mils (subtract the smaller from the larger: $2773 - 2719 = 54$ mils).
 - The second method uses the deflection conversion table (DCT, shown in Figure 8-6). Enter the DCT at the final range, rounded off to the nearest 100. Follow the deflection in meters line to the closest meters to cover the segment. The point at which the range line and the deflection line meet is the number of mils that will cover the segment.

RANGE IN METERS	DEFLECTION IN METERS														
	1	10	20	30	40	50	75	100	125	150	175	200	300	400	500
500	3.0	20	41	61	81	102	152	201	250	297	34	388	550	687	800
600	1.7	17	34	51	68	85	127	168	209	250	289	328	472	599	708
700	1.5	15	29	44	58	73	109	145	180	215	250	284	412	529	632
800	1.3	13	25	33	51	64	95	127	158	189	219	250	365	472	569
900	1.1	11	22	34	45	57	85	113	141	168	195	223	328	426	517
1000	1.0	10	20	31	41	51	76	102	127	152	176	201	297	388	473
1100	.93	9	18	28	37	46	69	92	115	138	161	183	271	355	435
1200	.85	8	17	25	34	42	64	85	106	127	148	168	249	328	402
1300	.79	8	16	23	31	39	59	78	98	117	136	155	231	304	374
1400	.73	7	15	22	29	36	55	73	91	109	127	145	215	283	349
1500	.68	7	14	20	27	34	51	68	85	102	118	135	201	265	328
1600	.63	6	13	19	25	32	48	64	80	95	111	127	189	250	309
1700	.60	6	12	18	24	30	45	60	75	90	104	119	178	235	291
1800	.57	6	11	17	23	28	42	57	71	85	99	113	168	223	276
1900	.54	5	11	16	21	27	40	54	67	80	94	107	160	211	262
2000	.51	5	10	15	20	25	38	51	64	76	89	102	152	201	250
2100	.49	5	10	15	19	24	36	48	61	73	85	97	145	192	238
2200	.46	5	9	14	19	23	35	46	58	69	81	92	138	183	228
2300	.44	4	9	13	18	22	33	44	55	66	77	88	132	175	218
2400	.43	4	8	13	17	21	32	42	53	63	74	85	127	168	209
2500	.41	4	8	12	16	20	31	41	51	61	71	81	122	162	201
2600	.39	4	8	12	16	20	29	39	49	59	68	78	117	155	194
2700	.38	4	8	11	15	19	28	38	47	57	66	75	113	150	187
2800	.37	4	7	11	15	18	27	36	45	55	64	73	109	145	180
2900	.35	4	7	11	14	18	26	35	44	53	61	70	105	140	174
3000	.34	3	7	10	14	17	25	34	42	51	59	68	102	135	168
3100	.33	3	7	10	13	16	25	33	41	49	57	66	98	131	163
3200	.32	3	6	10	13	16	24	32	40	48	56	64	95	127	158
3300	.31	3	6	9	12	15	23	31	39	46	54	62	92	123	153
3400	.30	3	6	9	12	15	22	30	37	45	52	60	90	119	149
3500	.30	3	6	9	12	15	22	29	36	44	51	58	87	116	145
3600	.29	3	6	8	11	14	21	28	35	42	49	57	85	113	141
3700	.28	3	6	8	11	14	21	28	34	41	48	55	82	110	137
3800	.27	3	5	8	11	13	20	27	33	40	47	54	80	107	133
3900	.27	3	5	8	10	13	20	26	33	39	46	52	78	104	130
4000	.26	3	5	8	10	13	19	26	32	38	45	51	76	102	127

Figure 8-6. Example of deflection conversion table.

- (6) To determine the number of turns it will take to cover one segment, divide the number of mils for each turn on the traversing handcrank by the mil width of one segment.

EXAMPLE

10 (number of mils for each turn) ÷ 54 = 5.4 (rounded off to the nearest 1/2 turn) or 5 1/2 turns to cover 116 meters

NOTE: Divide by 5 (mils per turn) when using the 120-mm mortar. There are 10 mils per turn of the deflection handwheel for both the 60-mm and 81-mm mortars.

- (7) To compute the number of turns between rounds, the number of rounds to be fired must be known for each segment (FFE). This information is in the FDC order. To determine the turns between rounds, divide the total turns by the intervals (always one less than the number of rounds) between rounds.

EXAMPLE

5 rounds	=	4 intervals; 5.5 (total turns) ÷ 4 (intervals):
5.5 ÷ 4	=	1.3 (rounded to nearest 1/2 turn)
1.3	=	1 1/2 turns between rounds

SEARCHING FIRE

8-53. Mortars use searching fires to effectively engage area targets that have more depth than a linear sheaf covers. Targets having more depth than 50 meters can be covered by mortars by elevating or depressing the barrel during the FFE.

8-54. In the CFF, the FO sends the target's size and attitude. He gives the width and depth on the target's attitude. Attitude is the direction (azimuth) through the target's long axis.

8-55. All mortar systems use searching fire. Before determining the search data, the FDC must compute any corrections sent with the FFE command and record the burst point grid coordinates.

- (1) Press the ADJ switch, and enter the target's attitude in place of the direction.

NOTE: Whether searching up or down, always determine the firing data for the far edge of the target area first. This saves time if the charge designated at the near edge differs from the one designated at the far edge.

- (2) When using searching fire, enter an add correction that is half the total target length. This places the mortars on the far edge of the target.
- (3) Compute and record the firing data for the far edge.
- (4) Enter a correction to place the mortars on the opposite edge of the target. The correction will be a drop, and the distance will be the entire length of the target area.
- (5) Compare the charge needed to hit the near edge of the target with the charge needed to hit the far edge. The charges must be the same. If they are not, select the charge designated for the far edge using the WPN/AMMO menu, and recompute the near edge firing data.
- (6) Determine the number of turns between rounds by determining the mil distance needed to cover the target area and dividing it by 10 (approximate number of mils in one turn of the elevation handcrank). Round off the answer to the nearest one-half turn. Compute the distribution of mortar fire to cover area targets (depth or width) at one round for each 30 meters and four rounds for each 100 meters.
- Compare the far edge elevation to the near edge elevation, and subtract the smaller from the larger.
 - Divide the mil distance by 10 (divide by 5 for the 120-mm mortar), and round off to the nearest half turn.
- (7) Determine the turns between rounds by dividing the intervals into the turns and rounding off to the nearest half turn. The intervals are always one less than the number of rounds in the FFE.

ILLUMINATION

8-56. Illumination assists friendly forces with light for night operations.

8-57. The FDC uses one of the flank mortars to adjust the illumination, leaving the base mortar ready to adjust HE rounds if a target is detected.

NOTE: Normally, when a four-mortar section is firing, the No. 4 mortar is used to adjust the illumination, leaving the No. 2 mortar as the base mortar. When the No. 1 mortar is used to adjust illumination, the No. 3 mortar becomes the base mortar.

8-58. The FO makes range and deviation corrections for illumination rounds in increments of no less than 200 meters. He also makes corrections for height of burst (up or down) in increments of no less than 50 meters.

8-59. Multiple mortar illumination procedures are used when single mortar illumination does not provide enough light or when visibility is poor. Two mortars, usually side-by-side, fire rounds at the same time at the same deflection, charge, and time setting to provide a large amount of light in a small area. If the FO suspects a large target or if he is uncertain of the target's location and wishes for a larger area to be illuminated, he may call for illumination:

- Range.
- Lateral.
- Range-lateral spread.

RANGE SPREAD

8-60. Two mortars fire one round each at the same deflection, but with different charges so that rounds burst at different ranges along the same line.

8-61. The spread between the rounds depends on the type of mortar firing the mission. The 120-mm mortar rounds have 1,500 meters between bursts, and the 81-mm mortar rounds have 500 meters between bursts.

8-62. When four mortars are present in the firing section, the No. 2 and No. 3 mortars normally fire the range spread. When firing a three-mortar section, the range spread may be fired with just one mortar, which fires both rounds. Follow these procedures:

- (1) Enter the type of target location called in by the FO into the MBC to initiate the mission. The weapon selected by the FDC in the WPN/AMMO menu (to activate the section) should be one of the mortars that will fire the mission. The initial firing data determined for the mission are center of mass target data. These data are not fired, but are used as the starting point for adjustment of the spread.
- (2) Enter the ADJ menu. Change the OT direction to GT direction, and enter a correction for the first round of the spread. Compute and record the firing data.
- (3) Select the ADJ menu, and enter a correction to achieve the required distance between rounds, which depends on the mortar system being used.
- (4) Compute and record the firing data, and fire the two rounds for the range spread.

NOTE: The two rounds should burst at the same time. The far round must be fired first, with the near round being fired afterward, at the difference between the time settings.

EXAMPLE

Assume the mortar selected to fire is the No. 2 mortar.

- (1) Enter the initial target location, and determine the center of mass data.
 - (2) Enter the ADJ menu, and give the No. 2 mortar a correction of +250 (for 81-mm mortars) or +750 (for 120-mm mortars).
 - (3) Compute and record these data.
 - (4) Enter the ADJ menu again, and make a correction of -500 (for 81-mm mortars) or -1500 (for 120-mm mortars).
 - (5) Compute and record these data.
 - (6) Use both sets of data to fire the rounds; rounds will burst at the desired length (1,500 meters for 120-mm mortars, and 500 meters for 81-mm mortars) between the rounds on the GT line.
-

NOTE: A range spread should be fired with one mortar firing both rounds— one long and one short.

LATERAL SPREAD

8-63. When using lateral spread, two mortars fire one round each at different deflections, but with the same charge. Therefore, the rounds burst at the same range, along the same attitude.

- (1) Use the No. 2 mortar to process the CFF, and determine firing data for the center of mass.
 - (2) Use the ADJ menu to enter left and right corrections. Use the GT as the direction, and enter the first correction.
-

NOTE: The No. 2 mortar is used for the initial round. The first correction can be either a right or left correction. For example, the first correction for the 81-mm mortar round is 250; the first correction for the 120-mm mortar round is L 750.

- (3) Compute and record the firing data.
- (4) Select the ADJ menu, and enter the reverse of the first correction, the entire distance required between rounds: L/R 500 meters for the 81-mm mortar, or L/R 1,500 meters for the 120-mm mortar.

RANGE-LATERAL SPREAD

8-64. If the target area is extremely large or if visibility is limited, the FO may call for a range-lateral spread (Figure 8-7). This procedure combines the two methods to form a large diamond-shaped pattern of bursts. Using flank mortars for the lateral spread and center mortars for the range spread removes the danger of rounds crossing in flight.

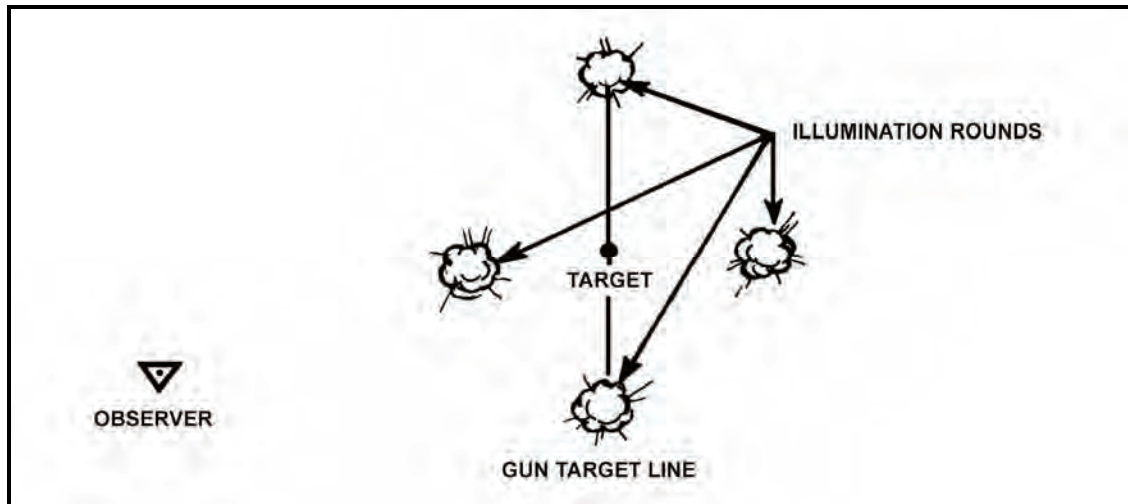

Figure 8-7. Range-lateral spread.

COORDINATED ILLUMINATION

8-65. When a suspected area is illuminated and produces a target, coordinated illumination is used to engage the target.

- (1) The illumination round has been adjusted over the target area. The computer receives a CFF for coordinated illumination.
- (2) The mark method is the method of coordinated illumination most commonly used. The FDC and the FO must know for which round the illumination mark will be given.
- (3) When the illumination round has been adjusted to provide the best light on the target, the FO gives the command, "Mark illumination." The FDC times the flight of the round from the time it is fired until the command, "Mark."
- (4) Before computing the time to fire the HE round, the computer drops all tenths and subtracts the time of flight for the HE round and the illumination round.

EXAMPLE

Illumination round - 53 seconds and the HE round - 19 seconds = time to fire the HE round will be 34 seconds after the illumination round is fired

- (5) When firing coordination missions, the computer operator uses a new DA Form 2399-R to record the illumination mission. The data used to fire the first illumination round is taken from the DA Form 2399-R used to adjust the illumination mission.
- (6) The FO sends corrections and precedes each correction with the type of round the correction is intended for. For example, "Illumination. Up five zero. HE. Right five zero. Add five zero." He records each correction on separate lines. The FDC keeps track of the 50-meter increments by using the DA Form 2399-R of the illumination mission.

- (7) There are two methods normally used to adjust illumination (mark method and shell) and HE. Coordinated illumination using the mark method involves the FDC controlling the firing of both the HE and illumination rounds, and coordinated illumination using the shell method involves FO commands. The FO controls the firing of each round. The FO sends corrections and computes the data that is sent to the mortars from the FDC. The mortars then report when they are up. The FDC notifies the FO, and the FO gives the command to fire each round.
- (8) When the FO is certain that he can hit the target with the next round, he commands, "Continuous illumination. Fire for effect" or "Continuous illumination. HE. Drop twenty-five. Fire for effect."
- (9) By requesting the continuous illumination, the FO is telling the FDC that he wants the target illuminated both during and after the fire for effect to allow him to make his target surveillance. Upon completion of the mission, he records the data on the DA Form 2188-R.

Chapter 9

Special Procedures

Procedures for basic fire missions are simple and require little coordination by the indirect fire team. The one element that is lacking in these procedures is accuracy, which the indirect fire team strives to improve. In-depth planning and prior coordination between the elements of the indirect fire team help ensure the delivery of timely and accurate fires. This chapter discusses the special procedures needed to conduct registration missions, FPF, and quick or immediate smoke.

REGISTRATION AND SHEAF ADJUSTMENT

9-1. If time and the tactical situation permit, the registration is the first mission completed. The two types of registration missions are coordinated and uncoordinated.

COORDINATED REGISTRATION

9-2. A coordinated registration is a planned mission using an available surveyed RP, known to at least an eight-digit grid coordinate. Firing corrections may be determined and applied after the registration mission is fired. The FDC usually initiates this mission.

UNCOORDINATED REGISTRATION

9-3. An uncoordinated registration is not planned, and units may not have a surveyed RP to fire upon. This registration is used mainly to adjust the sheaf and to establish a known point within the area of responsibility. If the RP is not surveyed, firing data corrections cannot be determined or applied. The FO usually initiates this mission.

MBC REGISTRATION PROCEDURES

9-4. When using the MBC for registration, the computer processes the mission as a standard grid mission until the FO determines that the registration is complete. He adjusts the basepiece onto the RP as in any standard adjust mission. Once the FDC receives a "Registration complete" call from the FO, he computes any refinement corrections received with the command. After these data are given to the mortars, the section fires a section left or a section right. The basepiece does not fire.

EXAMPLE

Consider a final correction of "Drop 25, registration complete," sent by the FO. Perform the following actions:

- (1) Use the ADJ menu to enter the correction of -25.
- (2) Press the COMPUTE switch to process the refinement data.

NOTE: Step 3 applies to coordinated registrations only.

- (3) Press the REG fire mission switch once the refinement firing data are available.
- (4) The registration number and FO identification (if the FO was entered with the CFF) are displayed.

- (5) Press the SEQ switch.
- (6) The mission target numbers are displayed.
- (7) Press the SEQ switch.
- (8) The FO's direction to the target is displayed.
- (9) Press the SEQ switch.
- (10) The RP grid is displayed.

NOTE: This grid is the initial grid used from the CFF, not the adjusting point grid.

- (11) Press the SEQ switch.
 - (12) The altitude of the RP is displayed.
 - (13) Press the SEQ switch.
 - (14) The weapon caliber and number of the adjusted piece are displayed.
 - (15) Press the SEQ switch.
 - (16) The charge used to reach the RP is displayed.
 - (17) Press the SEQ switch.
 - (18) The MBC provides a prompt to push COMPUTE to determine the firing corrections.
 - (19) Press the COMPUTE switch.
 - (20) The assigned RP number is displayed.
 - (21) Press the SEQ switch.
 - (22) The type of MET used and the range correction factor (RCF) are displayed.
 - (23) Press the SEQ switch.
 - (24) The type of MET used and the deflection correction are displayed.
 - (25) Press the SEQ switch.
 - (26) "READY" is displayed.
-

9-5. As shown in the example above, the MBC has determined the firing corrections; while it will not apply them to any subsequent data during this mission, it automatically applies the correction factors to all following missions that are within the transfer limits of this RP. The FDC copies this data to the appropriate spaces on the DA Form 2188-R.

9-6. To prepare the MBC for sheaf adjustments, the computer uses the TFC menu to change the control from "CON:AF" to "CON:FFE," and then presses the COMPUTE switch.

NOTE: The operator must change "CON:AF" to "CON:FFE" and press COMPUTE before adjusting individual guns.

9-7. The FDC initiates the sheaf adjustment by telling the FO, "Prepare to adjust the sheaf." The FO responds with, "Section left/right." The section left/right is fired without the basepiece, unless the FO specifies otherwise. The operator prepares to receive corrections for each mortar not firing within the sheaf. Then, he records the corrections and computes them separately.

NOTE: The MBC can only compute one correction at a time; therefore, if the computer records the corrections, he may compute for the corrections as he desires. Smaller corrections should be entered first since the mortars will not likely be fired again.

9-8. To adjust the sheaf—

- (1) Press ADJ.
- (2) Sequence to "ADJ:AUF" ("Adjusting:Adjusting Unit of Fire").
- (3) Change the "AUF" to "SHEAF."
- (4) Sequence to "WPN:."
- (5) Enter the number of the weapon that requires adjustment.

NOTE: The correction impacts only the weapon identified. Other weapons will still use the last firing data.

- (6) Enter the correction.
- (7) Compute the correction.

NOTE: If a correction is over 50 meters, the mortar will be refired. If the correction is less than 50 meters, the mortar will not be refired, but the correction will be made.

- (8) Use the ADJ switch, and sequence to "WPN:NXT CONT."
 - The abbreviation "WPN" is for weapon.
 - The abbreviation "NXT" is for the next mortar to adjust.
 - The abbreviation "CONT" means continue with the same mortar identified above.
- (9) Sequence to "WPN:."
- (10) Enter the weapon that requires adjustment and the correction.
- (11) Compute the correction.
- (12) Use the firing data menu to sequence through the data and record the new fire commands.

9-9. After the sheaf has been adjusted, the section/platoon must refer the sight and realign the aiming post on the last deflection of the basepiece used for the registration. The mission is ended using the EOM menu.

9-10. The computer uses the REG DATA menu to store and update information concerning the RP. Then, the MBC applies the correction factors to all subsequent fire requests that are within the transfer limits of the RP.

9-11. The RP must be updated for any MET data or reregistrations. To update or reregister on the RP, the computer follows the same procedures as a grid mission until the FO determines that the update or reregistration is complete. The operator will then—

- (1) Press the REG DATA switch.
- (2) Press the display switch under "NXT."
- (3) "RP00" is displayed.
- (4) Press the display switch under "CLR."
- (5) "CLEAR RP 00 *" is displayed.
- (6) Press the display switch under "*."
- (7) "RP: NXT CLR" is displayed.
- (8) Press the BACK switch until "READY" appears.
- (9) Press the REG switch.
- (10) Sequence through until "PUSH COMPUTE" appears.
- (11) Press the COMPUTE switch for a new deflection correction and RCF.
- (12) Press the EOM switch instead of EOMRAT. Data is stored already from the initial registration mission.

MEAN POINT OF IMPACT REGISTRATION

9-12. Special procedures permit registration under unusual conditions. This paragraph discusses one of the special procedures available, the mean point of impact (MPI) registration. Fire cannot be visually adjusted onto an RP at night without illumination. During desert, jungle, or arctic operations, clearly defined RPs are not usually available.

9-13. In an MPI registration, two FOs are normally used. For accuracy, the computer must know the location and altitude of each FO and enter the information into the MBC using the FO LOC menu. The computer must also know the expected point of impact and mortar position.

9-14. To determine the initial firing data—

- (1) Start the mission using the GRID menu.
- (2) Enter the expected burst point (as the grid to the target) and altitude.

NOTE: An FO ID and direction should not be entered using this menu.

- (3) Use the WPN/AMMO menu to assign the mission to an adjusting piece.
- (4) Press COMPUTE to determine the firing data and record the necessary information, such as the burst point to the target.

NOTE: The MBC does not allow access to the MPI menu under the ADJ switch until a mission has been activated using the GRID and WPN/AMMO menus.

9-15. After the FOs' locations and the target point are known, the FDC computes and reports the orienting data to the FOs.

NOTE: The FOs must be given their orienting data before firing.

9-16. To determine the observer's orienting data—

- (1) Press the ADJ switch.
- (2) Select "MPI:."
- (3) "FILE CONT INIT" is displayed.
- (4) Select "INIT" to initialize the MPI mission.
- (5) "INIT YES NO" is displayed.
- (6) Select "YES."
- (7) The MBC provides a prompt for one of the FOs' IDs.
- (8) Enter one of the FOs' IDs.
- (9) Press the SEQ switch.
- (10) The orienting direction for the FO entered displays.
- (11) Press the SEQ switch.
- (12) The vertical angle for the FO entered displays.
- (13) Press the SEQ switch.
- (14) Enter the target number.
- (15) Press the SEQ switch.
- (16) The orienting data are ready to be transmitted to the FO. If the MBC is DMD-supported, select "YES" to digitally transmit the information. If the MBC is not DMD-supported, select "NO."
- (17) The MBC provides a prompt for the other FO's ID.
- (18) Follow steps (8) through (16) for the other FO.

(19) If the MBC is not DMD-supported, transmit the orienting data to the FOs using the following format:

FDC: Prepare to observe MPI registration. Hotel 42. Direction 2580. Vertical angle +40. Hotel 41. Direction 2850. Vertical angle +10. Report when ready to observe.

9-17. The FOs should announce, "Ready to observe," after they have received their orienting data and have set up their instruments.

9-18. The section leader/chief computer directs the firing of the orienting round using the computed firing data. The FOs use the round to check the orientation of their instruments. The orienting round should be within 50 mils of the expected point of impact.

- If the round lands 50 mils or more away from the expected point of impact, the FO reorients his instrument and announces the new direction to the FDC. If one FO reorients his instrument, the other FO's spotting is disregarded. When either of the FOs must reorient, the operator enters the new direction using the ADJ menu and follows these procedures:
 - Enter the ADJ menu.
 - Press the ADJ switch.
 - Select "MPI."
 - Select "INIT."
 - Reenter the FO's ID when prompted.
- If the burst impacts less than 50 mils away from the expected point of impact, the FO sends the FDC a spotting. The spotting contains the number of mils left or right of the expected point of impact.

9-19. When both FOs report that their instruments are ready, the adjusting mortar fires the number of rounds needed to get six usable spottings. The FDC enters these spottings into the MBC.

9-20. To enter the spottings into the MBC—

- (1) Press the ADJ switch.
- (2) Select "MPI."
- (3) The computer displays "FILE CONT INIT."
- (4) Select "FILE" to enter the spottings.
- (5) The MBC requests the sighting number.
- (6) Enter the sighting number.
- (7) Press the SEQ switch.
- (8) Determine the azimuth from the FO to the target using the RALS (right add, left subtract) rule. Add or subtract this correction from the FO's referred (orienting) direction. Enter the azimuth as the FO's direction.
- (9) Press the SEQ switch.
- (10) The MBC prompts for the vertical angle from the FO to the round. Enter the vertical angle, if any.
- (11) Press the SEQ switch.
- (12) The second FO's ID is displayed.
- (13) Enter the sighting number.
- (14) Determine the azimuth from the FO to the target using the RALS rule. Add or subtract the correction from the FO's referred direction. Enter the azimuth as the FO's direction.

NOTE: The MBC computes for only one vertical angle correction. This correction applies only to the first FO entry. When the vertical angle entry must be computed, the operator ensures that the proper FO is entered.

- (15) Press the SEQ switch.
- (16) The MBC prompts the operator for the next sighting.
- (17) Press the COMPUTE switch.
- (18) Enter the FOs' sightings as described until all sightings have been entered. After the last sighting has been entered, select "END" on this display.
- (19) Press the COMPUTE switch.
- (20) Sequence to view the RP corrections.
- (21) Press the EOM switch to end the mission.

RADAR REGISTRATION

9-21. The radar registration requires only one OP: radar. It requires less survey, fewer communication facilities, and less coordination. Radar registration can be conducted quickly and during poor visibility.

NOTE: Radar registrations may be conducted as grid or polar plot missions. Grid mission procedures are discussed below.

9-22. Radar registration missions are coordinated missions and are conducted as normal grid missions with the following exceptions:

- The FO does not send corrections; he sends grid coordinates to the impact of the rounds fired.
- The FDC, instead of the FOs, converts spottings to corrections.

9-23. The following example depicts a radar registration mission and outlines the proper procedures.

EXAMPLE

- (1) The FDC sends an MTO: "Prepare to register RP 1, grid 03817158."
- (2) The radar operator orients his radar set and tells the FDC, "Ready to observe."
- (3) The first round is fired, and the radar operator sends a grid of the round's impact point to the FDC.
- (4) The FDC records the eight-digit grid coordinates and compares it to the RP grid coordinates to determine the spotting. Then, he sends a grid (03557120) to the first round fired.

	Easting	Northing
RP grid	0381(0)	7158(0)
First round grid	- 0355(0)	- 7120(0)
	26(0)	38(0)

NOTE: To use 10-digit grid coordinates, add a zero to the end of each easting or northing coordinate until there are 10 digits. For example, the grid 123456 becomes 1230045600.

- Using a blank piece of scrap paper, the FDC draws a large square to represent a 1,000-meter grid square.
- The FDC labels the bottom left corner of the square with the grid intersection of the RP (03/71) (Figure 9-1).
- He divides the large square into four smaller squares by drawing a line through the center of the box from top to bottom and from left to right.
- He estimates the location of both grid coordinates and plots them inside the box.
- By looking at these plots, the FDC can tell whether the round is left or right and over or short of the RP. This is the spotting of the round. For this example, the spotting is left (260 meters) and short (380 meters).

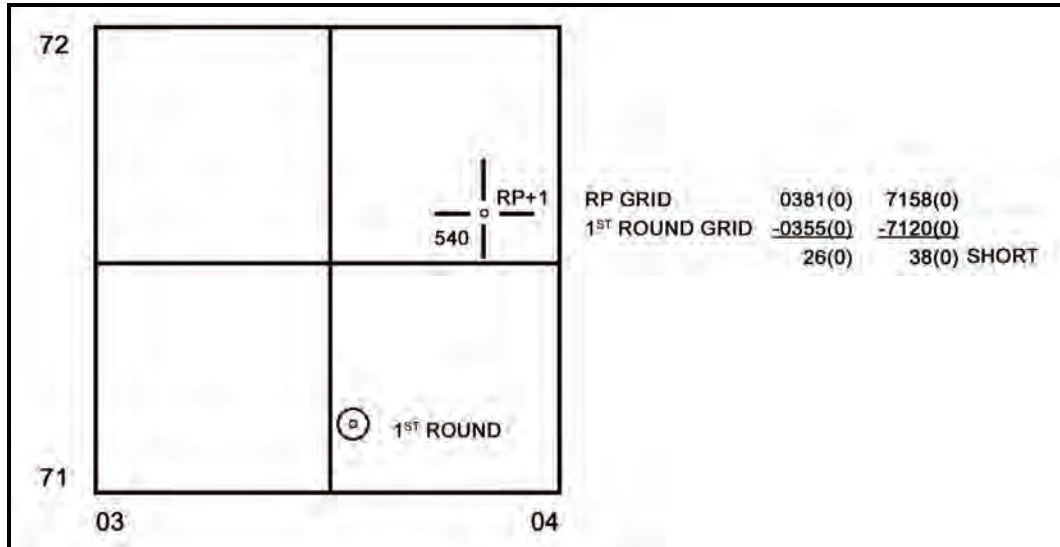

Figure 9-1. Determination of a spotting.

- The spotting is then converted to a correction by converting the left spotting to a right correction (R 260) and the short spotting to an add correction(+ 380). Using the ADJ menu, the operator enters the corrections:
 - Change the direction to 6400 (or 0000).
 - Enter "R 0260" for the deviation correction.
 - Enter "+ 0380" for the range correction.
 - Sequence to "READY."
 - The operator then computes the firing data and sends it to the guns.
- (5) The second round is fired, and the FO sends the grid coordinates (04007180). The second correction follows the same process as the first correction.
- The FDC compares the grids and determines the spotting ("Right 190" and "Over 220").
 - The corrections (L 190 and - 220) are made in the ADJ menu, and the firing data are sent to the mortars.
- (6) The computer repeats this procedure until the spotting is within 25 meters of the RP and the FO has given "End of mission, registration complete." The FDC—
- Enters the final correction through the ADJ menu and computes the data.
 - Presses the REG switch and sequences through the REG menu. He ensures that the data pertaining to the RP are correct.
 - Presses COMPUTE when indicated at the end of the REG menu to determine the RCF and deflection correction (DEFK).

- (7) After the registration is completed, the FDC informs the FO, "Prepare to adjust the sheaf." To adjust the sheaf—
- The FDC converges the sheaf on the RP. Using the TFC switch, the operator changes the method of control (CON) from "AF" to "FFE."
 - The operator sequences through the menu, ensuring that all data match with the FDC order. He presses the COMPUTE switch when the MBC reads "PUSH COMPUTE."
 - All mortars are fired (except the BP) at 10- to 20-second intervals.
 - The radar operator sends the FDC the grid coordinates of the impact of each round fired.
 - The FDC compares the impact grid coordinates with the grid coordinates of the RP and determines the deviation corrections for each mortar. THE FDC DOES NOT USE RANGE CORRECTIONS.

- NOTES:**
1. The operator compares the full grid coordinates of all rounds fired. Any extreme deviation or range spotting means that there is a problem in the setup of that mortar position.
 2. If the operator is using the MBC to apply these corrections, he must first enter and compute all corrections under 50 meters.

- All corrections more than 50 meters are refired, the new grids are compared to the RP grid, and the new data are computed for those weapons.
- (8) Once the sheaf is adjusted, the FDC must open the sheaf. Using the DCT, the FDC opens the sheaf mathematically the distance required based on the mortar system used.
- (9) The FDC now has the mortars refer their sights to the hit data (the deflection, elevation, and charge used to hit the RP).

FINAL PROTECTIVE FIRES

9-24. PPFs are the highest priority missions that the mortar section/platoon fires. They are prearranged barriers of fire designed to protect friendly troops and to stop the enemy's advance. When integrated with the supported units' other weapons, PPF cover dead space and likely avenues of approach. Normally, mortar PPFs are targeted on an avenue of likely dismounted attack. They can be any distance from the friendly position that fits into the ground commander's situation, but are always within the range of organic direct-fire weapons (normally within 100 to 400 meters of friendly troops) (Table 9-1).

NOTE: The approximate widths below are based on linear sheaves.

Table 9-1. Normal final protective fire dimensions, for each number of mortars.

SIZE	TYPE	AMMUNITION SERIES	NUMBER OF MORTARS	WIDTH	DEPTH
				(in meters)	
120-mm	M120	M9xxxx	4 (platoon)	240	70
120-mm	M120	M9xxxx	2 (section)	120	70
81-mm	M252	M3xxxx	4 (platoon)	140	40
81-mm	M252	M3xxxx	2 (section)	70	40
81-mm	M252	M8xxxx	4 (platoon)	160	50
81-mm	M252	M8xxxx	2 (section)	80	50
60-mm	M224	M7xxxx	2 (section)	50	30

NOTE: Ammunition is listed by series. M8xxxx represents all ammunition beginning with the prefix M8, such as M821 or M889.

PRECAUTIONS

9-25. The target location given in the CFF is not the FPF's location. The FO must add a 200- to 400-meter safety factor to the FPF's location, but the FDC never adds a safety factor. Since the FPF is adjusted to within 200 meters of friendly forces—

- The adjustment is danger close.
- The creeping method of adjustment is used.

PROCEDURES

9-26. FPF adjustments can be fired using one of two methods (in order of preference):

- Adjusting mortar-by-mortar.
- Adjusting danger close mortar only.

Adjustment Mortar-by-Mortar

9-27. In the CFF, the FO may give a section left or a section right to determine the danger close mortar (the one impacting closest to friendly forces).

9-28. The operator uses the FPF switch to enter, compute, adjust, review, and delete data for FPFs. Three FPFs may be stored and identified as line 1, 2, or 3, with each line located by a set of grid coordinates marking the left or right limit. The stored data include the line number and fire commands for each weapon assigned (up to six) for that line.

9-29. Then the altitude, width, and attitude are entered. When the corrections for each adjusting weapon have been entered and recomputed, they are stored. Further corrections are not applied after advancing to the next weapon. The corrections made to each mortar are automatically applied to the next weapon to be adjusted. Follow these procedures:

-
- NOTES:**
1. The FO will tell the FDC the left or right limit grid (for example, L140 versus FPF grid).
 2. All adjusting rounds should be set for fuze delay to further reduce the danger to friendly forces. After entering the FPF line, a safety fan may be entered.
-

- (1) Press the FPF switch.
 - (2) Select "INIT."
 - (3) Enter the line number (1, 2, or 3) and the section/weapon number.
 - (4) The display shows "LINE: 1 WPN:A1."
 - (5) Press the SEQ switch.
-

NOTE: The default entry for shell/fuze combination (HE PD) is normally not changed.

- (6) Press the SEQ switch.
- (7) Select the GT, or enter the FO's direction to target.
- (8) Press the SEQ switch.
- (9) Enter the FPF right or left limit.

NOTE: If the right limit grid coordinates are entered for the FPF, adjust the right flank mortar first. If the left limit grid coordinates are entered for the FPF, adjust the left flank mortar first.

- (10) Press the SEQ switch.
 - (11) Enter the FPF altitude (if known).
 - (12) Press the SEQ switch.
 - (13) Enter the left or right limit and the FPF line width in meters.
 - (14) The display shows "L R WID: L 350." The coordinate point becomes the left or right limit.
-

NOTE: The direction of the FPF should be left if the right flank mortar (No. 1) is adjusting and right if the left flank mortar (No. 3 or No. 4) is adjusting.

- (15) Press the SEQ switch.
 - (16) Enter the attitude of the FPF.
-

NOTE: The attitude of the FPF is a MANDATORY ENTRY.

- (17) Press the SEQ switch.
 - (18) Follow the MBC's instructions.
 - (19) Press the COMPUTE switch to receive firing data.
 - (20) Sequence through the firing data until "ADJ *" is displayed.
-

NOTE: If the "ADJ*" selection is passed, the MBC displays "READY." To continue adjusting the FPF, press the FPF mission switch, and select "ADJ." Proceed to step 22.

- (21) Select the display key beneath the asterisk (*).
 - (22) Enter the number of the weapon that requires adjustment. If another weapon is to be adjusted, select NXT.
-

NOTE: The MBC considers the previous weapon adjusted, and it saves the firing commands in the FPF data file. When the last weapon is adjusted, select NXT in this display to end the mission. The MBC displays "FPF ADJUSTED."

- (23) Press the SEQ switch.
- (24) The MBC displays the direction to the target.
- (25) Press the SEQ switch.
- (26) Enter the deviation correction from the FO (if any).
- (27) Press the SEQ switch.
- (28) Enter the range correction (if any).
- (29) Press the SEQ switch. (The operator may change the height corrections from meters [default] to feet.)
- (30) Press the SEQ switch.
- (31) Enter the vertical correction from the FO (if any).
- (32) Press the SEQ switch.
- (33) The MBC displays "PRESS COMPUTE."
- (34) Press the COMPUTE switch to receive the firing data.
- (35) Repeat the procedures in steps 20 through 34 until each weapon in the section has been adjusted. Repeat the procedures in steps 20 through 21 to end the mission.

Adjustment of Danger Close Mortar Only

9-30. In the CFF, the FDC is given the attitude of the target area. From this attitude, the FDC can determine the danger close mortar.

- The operator uses the FPF menu to fire and adjust as with the mortar-by-mortar method.
- Once the danger close mortar is adjusted, the other mortars involved in the FPF will have firing data already computed.
- The difference between this method and the mortar-by-mortar adjustment method is that each mortar will not actually fire on the FPF. Rather, the firing data for the nonfiring mortars are calculated based on the firing data for the danger close mortar and the attitude of the target area.

DATA REVIEW

9-31. The FPF data for the section may be reviewed at any time using the FPF menu switch. To review the data—

- (1) Press the FPF switch, and select "DATA."
- (2) Press the SEQ switch, and enter the line number of the FPF to be displayed.
- (3) Sequence through the display to review each mortar's data.

SAFETY DATA

9-32. After an FPF has been initiated, the operator can review the safety data at any time. To review the data—

- (1) Press the FPF mission switch. The sequence indicator should blink, indicating that another choice is available (for multiple entries).
- (2) Press the SEQ switch.
- (3) The fifth choice, "SFTY," is displayed.
- (4) Select the display key beneath the flashing cursor to select "SFTY."
- (5) Press the SEQ switch.
- (6) Enter the line number of the FPF safety data to be viewed.
- (7) Press the SEQ switch.
- (8) The MBC provides a prompt to press the SEQ switch to view the burst-point grid coordinate.
- (9) Press the SEQ switch.
- (10) The easting and northing are displayed.
- (11) Press the SEQ switch.
- (12) The maximum ordinate of the last round to its burst-point is displayed.
- (13) Press the SEQ switch.
- (14) The time of flight is displayed.
- (15) Press the SEQ switch.
- (16) "READY" is displayed.

IMMEDIATE SMOKE OR IMMEDIATE SUPPRESSION

9-33. When engaging a planned target or a target of opportunity that has taken friendly forces under fire, the FO announces (in the CFF) either immediate smoke or IS. The delivery of fires is performed as quickly as possible; immediate response is more important than the accuracy of these fires.

- FOs use immediate smoke missions to obscure the enemy's vision for short periods. This aids maneuver elements in breaking contact or evading enemy direct fire; these missions are not intended as screening missions.

NOTE: Immediate smoke missions can cover an area of 160 meters or less (four guns, 81-mm mortars; 240 meters, four guns, 120-mm mortars).

- FOs use immediate suppression missions to indicate that the unit is receiving enemy fire. This request should be processed at once. Planned and delivered to suppress the enemy, these fires hamper enemy operation and limit his ability to perform his mission in the target area.

9-34. The procedures for firing an IS or immediate smoke mission are the same except for the ammunition used. High-explosive quick (HEQ) is used for the immediate suppression mission, and WP or red phosphorus is used in the immediate smoke mission.

9-35. The procedures for firing these missions follow:

- (1) The FDC receives a CFF from the FO. In the warning order, the word "immediate" will precede either "suppression" or "smoke."
- (2) The target location is normally expressed using grid coordinates. The FDC processes this CFF as a normal grid mission using the GRID menu with one exception. After the WPN/AMMO menu displays, the FDC will immediately use the TFC switch and change the method of control (CON) from "AF" to "FFE."

NOTE: The TFC menu may be deleted from this procedure if the mortars to fire are parallel to the rest of the section and if they are all the same distance apart (a perfect linear position).

WARNING

Using the default firing data for all guns in the firing section may cause rounds to be fired outside of the safety fan or firing zone. Therefore, always use the TFC menu when a safety fan or firing zone is used. The MBC will warn the operator if any of the rounds for a weapon will land outside the safety fan or firing zone. For revision III/A, the operator must override the message in order to continue.

- (3) If any adjustments are needed, the entire section conducts them, firing the same number of rounds each time, as in the previous command.

QUICK SMOKE

9-36. The techniques that mortar units use to attack targets with smoke are influenced by factors independent of the mission. These factors include—

- Weather.
- Terrain.
- Dispersion.
- Adjustment.
- Distribution of fire.
- Ammunition availability.

9-37. Clearance to fire, ammunition requirements, and general considerations discussed in this segment apply to all mortars.

9-38. The mortar unit establishes screening smoke between the enemy and friendly units or installations. It uses smoke to—

- Hamper observation.
- Reduce observed fire.
- Hamper and confuse hostile operations.
- Deceive the enemy as to friendly operations.

9-39. The main consideration in planning for a smoke screen is that it must accomplish its purpose without interfering with the activities of friendly forces. This requires much planning. Authority to fire smoke missions rests with the highest commander whose troops will be affected. The unit commander must ensure that flank unit commanders who may be affected have been informed.

9-40. Normally, the section/platoon is given a smoke mission through command channels. The methods used to accomplish the mission are not usually prescribed, but are developed by the section leader/chief computer and the FO who will conduct the mission. The following factors help in deciding how to engage the target.

AMMUNITION

9-41. The number of rounds required to establish and maintain a screen is based on the target's size and the weather conditions affecting the dispersion of the smoke. The chief computer cannot accurately determine the weather conditions that will exist at the time the mission is fired, but he does determine the amount of ammunition for the most unfavorable conditions that might be expected.

9-42. A quick smoke mission is usually conducted in three phases:

- Phase 1: Adjustment Phase. The computer adjusts the upwind flank mortar to the upwind edge of the target area using HE ammunition. At the end of this phase, one round of WP is fired to see if it hits the desired location.
- Phase 2: Establishment Phase. The computer establishes the screen by firing twice the number of rounds required to maintain the screen for one minute, but not less than 12 rounds. These rounds are fired as quickly as possible (FFE phase for any other mission).
- Phase 3: Maintenance Phase. The computer maintains the screen by firing the determined number of rounds per minute (RPM), times the length of time the screen is to be in place.

9-43. The computer uses the smoke chart to compute the number of rounds needed to maintain a screen for one minute (Tables 9-2 and 9-3). This chart is prepared for various weather conditions and a screen 500 meters wide. Other widths are computed by scaling the values proportionally. To extract the proper value from the chart, the FDC must know the—

- Wind speed (confirmed by the FO before firing).
- Wind direction (confirmed by the FO before firing).
- Relative humidity (obtained from the battalion S2 or by estimation).
- Temperature gradient (obtained from the battalion S2 or by estimation).

9-44. The temperature gradient is a measure of how air temperature changes with altitude. It determines which line to use. Neutral occurs when there is no appreciable temperature change with an increase in altitude (midday). It is the most common condition. Lapse conditions exist when the temperature changes with an increase in altitude (evening). Inversion conditions exist when the temperature rises with an increase in altitude (early morning).

9-45. The wind speed in knots determines which column to use. The box where the proper row and column intersect contains the number of RPM needed to maintain a screen 500 meters wide for one minute with a flank wind. The result (8.0, in this example) is always rounded up (no less than 12 rounds will be fired in the establishment phase). Each mortar fires as follows:

- 120-mm mortar four gun platoon, 3 rounds each.
- 120-mm mortar two gun section, 6 rounds each.
- 81-mm mortar platoon, 3 rounds each.
- 81-mm mortar section, 6 rounds each.

EXAMPLE

For conditions of 60 percent humidity, a neutral temperature gradient, and a 4-knot wind, it would take 4 rounds per minute to maintain a 500-meter screen with a flank wind. This is the smoke chart table value.

To scale the screen to a different width, use the following procedure:

- (1) Express the width as hundreds of meters.

400 meters would be expressed as 4.

- (2) Multiply this number by 0.2 (the 500-meter scaling factor) to get the width factor.

4 (the width, in 100s of meters) x 0.2 (the 500-meter scaling factor) = 0.8 (width factor)

- (3) Multiply the width factor by the table value for total rounds per minute.

0.8 (width factor) × 4 (table value) = 3.2

- (4) Round this value (3.2) to the nearest whole number. This is the total number of rounds to maintain for 1 minute.

3.2 = 4 (rounds per minute)

Table 9-2. Smoke chart for the 120-mm M929 WP.

Smoke Ammunition Requirements for 120-mm M929 WP								
Number of M929 WP rounds per minute to maintain a smoke curtain on a 500-meter front in flank winds. See items (1), (2), and (3) below.								
RELATIVE HUMIDITY (PERCENT)	TEMPERATURE GRADIENT	WIND SPEED (KNOTS)						
		2	4	9	13	18	22	26
30	LAPSE	12	6	6	6	6	8	12
	NEUTRAL	12	6	4	4	6	8	12
	INVERSION	6	6	3				
60	LAPSE	12	4	4	6			
	NEUTRAL	12	4	3	4	6	6	8
	INVERSION	6	6	3				
90	LAPSE	8	4	3	4			
	NEUTRAL	8	3	3	3	4	6	6
	INVERSION	6	4	3				

(1) Employ volley fire to establish a smoke curtain, using a two-minute ammunition requirement (but not less than 12 rounds). Equally space rounds on the front to be curtailed.

(2) For quartering winds, multiply table values by 2; for tail winds, by 2; and for head winds, by 2 1/2. Values for head and tail winds are based on curtain impact lines of 500 meters in front of enemy lines. Wind directions are indicated with respect to the enemy target or the smoke screen. If the curtain impact line is 500 meters, ammunition requirements will be considerably larger. OBSERVERS MUST CONTROL FIRES AT ALL TIMES.

(3) The upwind adjustments point is 100 meters.

(See FM 3-50 or FM 6-30 for an explanation of temperature gradient conditions.)

The total number of smoke rounds needed for the mission is computed as follows:

Adjustment phase	=	1 round (confirmation round)
Establishment phase	=	2 x number of rounds to maintain for one minute; must be at least 12 rounds
Maintenance phase	=	Number of rounds to maintain for one minute times the total number of minutes
Total rounds for the mission	=	adjustment phase + establishment phase + maintenance phase

NOTE: The time used during the establishment phase is not to be considered to be part of the maintenance phase.

Table 9-3. Smoke chart for the 81-mm M819 red phosphorus.

Smoke Ammunition Requirements for 81-mm M819 red phosphorus								
Number of M819 RP rounds per minute to maintain a smoke curtain on a 500-meter front in flank winds. See items (1), (2), and (3) below.								
		WIND SPEED (KNOTS)						
RELATIVE HUMIDITY (PERCENT)	TEMPERATURE GRADIENT	2	4	9	13	18	22	26
30	LAPSE	6	6	12	12	16		
	NEUTRAL	2	4	8	8	16	24	24
	INVERSION	2	3	8				
60	LAPSE	6	6	8	8	16		
	NEUTRAL	2	3	6	8	12	16	24
	INVERSION	2	2	6				
90	LAPSE	2	3	8	8	12		
	NEUTRAL	2	2	6	8	8	12	16
	INVERSION	1	2	4				

(1) Employ volley fire to establish a smoke curtain, using a two-minute ammunition requirement (but not less than 12 rounds). Equally space rounds on the front to be curtained.

(2) For quartering winds, multiply table values by 2; for tail winds, by 2; and for head winds, by 2 1/2. Values for head and tail winds are based on curtain impact lines of 500 meters in front of enemy lines. Wind directions are indicated with respect to the enemy target or the smoke screen. If the curtain impact line is 500 meters, ammunition requirements will be considerably larger. OBSERVERS MUST CONTROL FIRES AT ALL TIMES.

(3) The upwind adjustments point is 100 meters.

(See FM 3-50 or FM 6-30 for an explanation of temperature gradient conditions.)

MORTARS REQUIRED

9-46. Under favorable conditions, a 120-mm mortar platoon can screen an area about 800 meters wide and an 81-mm mortar platoon can screen an area about 500 meters wide.

NOTE: 60-mm mortar sections are not normally used to produce large-scale smoke screens. They can be used to augment the screening smoke of a larger caliber mortar unit, and they can produce useful point obscuration during urban operations.

9-47. A limitation, however, is their maximum and sustained rates of fire. For the entire platoon, the rates of fire are multiplied by the number of mortars firing. If the required number of RPM exceeds the rate of fire, the platoon must request supporting fire from flank units or artillery.

EFFECTS DESIRED

9-48. If smoke is to be placed directly on the target for blinding or casualty-producing effects, the FO adjusts the center of impact of the rounds onto the center of the target. The number of RPM to produce this effect is twice that for a normal quick smoke mission.

ORDERING OF AMMUNITION

9-49. When ordering ammunition for a mission, the FDC estimates the weather conditions, remembering that it is better to have too much ammunition than too little.

BRIEFING OF THE OBSERVER

9-50. Due to the many clearances required to fire the mission, the FDC chief or section leader normally has ample time to brief the FO on the quick smoke screen. This briefing should include a map reconnaissance of the area to be screened so that the FO can identify it on the ground and select an OP from which the screen can be observed.

CALL FOR FIRE

9-51. At the appointed time, usually 10 to 20 minutes before the mission is to be fired, the FO sends the CFF. This provides the time needed for the FDC to process the data and prepare the necessary ammunition.

NOTE: The CFF should specify the wind direction.

EXACT AMMUNITION REQUIREMENT

9-52. About the time that the CFF is received, the chief computer/section leader makes a final check on the weather and directs the computation of the exact ammunition requirements for the mission. The section/platoon breaks down (at least) this amount of ammunition and prepares it to be fired.

MISSION COMPUTATION

9-53. The chief computer/section leader issues the FDC order (Figure 9-2). The method of FFE is the number of rounds computed to establish the screen, divided by the number of mortars to FFE. The chief computer/section leader commands the time of opening fire. Once the first round of smoke is fired, all commands should be such that they can be applied with minimal reaction time.

FDC ORDER	
MORTAR TO FIRE:	<u>SEC</u>
MORTAR TO ADJUST:	<u>#4</u>
METHOD OF ADJUST:	<u>1 RD</u>
BASIS FOR CORRECTION:	<u> </u>
SHEAF CORRECTION:	<u>OPEN 300M</u>
SHELL AND FUZE:	<u>HE/WP I/A</u>
	<u>RP IN FFE</u>
METHOD OF FFE:	<u>4 RDS</u>
RANGE/LATERAL SPREAD:	<u> </u>
ZONE:	<u> </u>
TIME OF OPENING FIRE:	<u>W/R</u>

Figure 9-2. Fire direction center order.

9-54. The following procedures are used in mission computation:

- (1) Upon receipt of the FDC order, the MBC operator processes the fire commands as he would a normal grid mission until the final correction.

NOTE: HE is adjusted to within 100 meters of the adjusting point.

- (2) The FO splits the 100-meter bracket and calls for one round of WP (in adjustment) to see if it will strike the adjusting point and if the weather conditions are affecting the smoke as predicted.
- (3) The MBC operator uses the WPN/AMMO menu to change the shell and fuze combination.
- (4) After the shell and fuze correction is entered, the MBC operator computes the final adjustment and relays this information to the adjusting mortar.
- (5) The FO makes corrections for the WP. When the FO requests FFE, the FDC tells the mortars how many rounds to fire (employing volley fire).
- (6) The maintenance phase begins almost immediately after the establishment phase. If the FO notices the screen thinning in one place (usually the upwind end), the rate of fire may be doubled for one or more mortars. The FO can adjust the placement of the WP during any part of the maintenance phase by specifying which gun(s) will continue firing or by transmitting a correction.

FOUR PHASES TO SCREENING MISSION

9-55. When a linear sheaf will not cover the area, a screening mission is conducted. Screening missions have four phases:

- Phase 1. Using HE ammunition, the FO adjusts the upwind flank mortar to the upwind edge of the area to be screened.
- Phase 2. At the end of the adjustment phase, the mortars fire one round of smoke to see if it hits the adjustment point.
- Phase 3. The FO calls for the sheaf to be opened.

NOTE: Do not confuse this step with a normal open sheaf.

- Phase 4. The FDC presses the TFC switch and performs the following procedures:
 - (1) Change "SHEAF:PRL" to "SPECIAL."
 - (2) Select "ADJ PT:FLANK."
 - (3) Enter the direction and size of the screen based on the adjusting (upwind) mortar. If No. 1 mortar is adjusting, select "L" (Left) and enter the size of the area to be screened. If the No. 3 (or 4) mortar is adjusting, select "R" (Right) and enter the size of the area to be screened.
 - (4) Enter the attitude of the target area.
 - (5) Change "CON:AF" to "CON:FFE."
 - (6) Push COMPUTE and observe the firing data.

END OF MISSION

9-56. The control in ending the screening mission rests with the commander who ordered it established. Normally, screens are fired according to a time schedule; however, the commander may order the screen to be maintained beyond the scheduled termination time. In the absence of external control, the FDC controls the timing, ordering the section/platoon to cease fire. Squad leaders give the FDC a count of the rounds expended (or remaining) at the end of the mission.

SPECIAL KEYS AND FUNCTIONS

9-57. This paragraph describes some of the functions of the following special keys:

- Message (MSG).
- Review (REVIEW).
- Survey (SURV).
- Mission (MSN).
- Transmit (XMIT).
- Safety Data (SFTY DATA).

MESSAGE SWITCH

9-58. A maximum of three incoming digital messages can be stored. Incoming messages are of two types: fire request and information-only.

9-59. When the message indicator is lit or the audio alarm sounds and the MSG switch is pressed, the first line of the first message received is displayed. When the message is a fire request, the MBC automatically assigns a mission and target number, unless there are already three active missions. If so, the MBC displays "NO AVAIL MSN" and discards the message. This menu includes the information outlined in Table 9-4.

Table 9-4. Message switch entries and related information.

ENTRY	RELATED INFORMATION
FR GRID (SHIFT, POLAR, or LASER)	Fire request using grid coordinates, shift from a known point, polar plot corrections, or laser data
OBS LOC	FO location data
SUBQ ADJ	Subsequent adjustment to a fire request
SA COORDS	Subsequent adjustment using coordinates
PREC ADJ	Precision adjustment
SA LASER	Subsequent adjustment to a laser fire request
EOM & SURV	End of mission and surveillance data
FPF	Request for FPF
QF KNPT or QF TGT	Quick fire request on a known point or known target
ASKNPT	FO request to assign a known point number
FO CMD	FO command message
HB/MPI	High burst/mean point of impact
FL TRACE	Front-line trace data
RDR REG	Radar registration data
FREE TEXT	Free text form messages

REVIEW SWITCH

9-60. The REVIEW switch returns the display to the first line of a message or to the beginning of the last main menu selected.

SURVEY SWITCH

9-61. The SURV switch can be used to solve three survey problems:

- Resection (RES).
- Intersection (INT).
- Traverse (TRV).

9-62. These functions are used to determine the coordinates and altitude of an unknown point using measurements from known point(s). Computed coordinates may be stored as a—

- Basepiece.
- FO.
- Known point.
- Target.

NOTE: Before using any of the SURV functions, the operator must enter the known points into the MBC using the KNPT/TGT menu.

MISSION SWITCH

9-63. The MSN switch is used to review current active fire mission data and to specify which mission is operational. The MBC can store data for three active fire missions and compute fire commands for each of these missions one at a time.

9-64. The MBC assigns a mission and target number to a mission each time the GRID, SHIFT, or POLAR switch is pressed. Use these switches only when starting a fire mission to avoid misuse of target numbers.

-
- NOTES:**
1. The operator can enter or change data for operational missions only.
 2. A mission must be active before the WPN AMMO, REG, TFC, SFTY DATA, EOM, and REPLOT switches can be used to input or display data.
-

TRANSMIT SWITCH

9-65. The XMIT switch is used to display or send MTO and command messages when operating in manual or digital mode. This menu includes the information outlined in Table 9-5.

Table 9-5. Transmit switch entries and related information.

ENTRY	RELATED INFORMATION
NR VOL	The number of volleys for the FFE
NR UNITS	The number of units to be used in the FFE
PR ERR:	The probable error entered by the MBC
ADJ SF	Adjusting shell/fuze entered by the MBC
1ST SF:	Shell/fuze for the first round for FFE entered by the computer
SUBS SF	Shell/fuze combination for subsequent rounds for FFE entered by the MBC
MOE	Method of engagement NOTE: Use the default value.
CON: WR AF	Method of control (WR = when ready, and AF = adjust fire)
TOF	Time of flight for the next (or last) round
ANG T	Angle T entered by the computer

SAFETY DATA SWITCH

9-66. The SFTY DATA switch is used to review the safety factors in effect for a current fire mission. This menu includes the information outlined in Table 9-6.

Table 9-6. Safety Data switch entries and related information.

ENTRY	RELATED INFORMATION
RN: AZ	Range and azimuth from the guns to the target (GT)
BURST POINT SEQF	The coordinate of impact for the round fired can be found by sequencing forward (SEQF).
BP	Burst point easting and northing grid coordinates
MAX ORD	The maximum ordinate (top of the trajectory) of the round fired, measured in meters from sea level
SAFETY DIAGRAM	Entries can be made to store up to three safety fans (one for each section/platoon in WPN DATA menu) identified as A, B, or C
LLAZ	Left limit azimuth in mils
RLAZ	Right limit azimuth in mils
MAX RN	Maximum range in meters
MIN RN	Minimum range in meters
MIN:_ MAX	Minimum and maximum charges

This page intentionally left blank.

Chapter 10

Digital Device Support

The MBC may transmit and receive digital communications using a DMD or the FOS. This ability reduces the mission processing time and provides a more secure communication network.

APPLICATION

10-1. All DMD-supported missions occur in response to the receipt of an FO message. The input data for the mission are supplied by digital transmission from the FO's DMD and automatically entered into the MBC's memory.

10-2. To conduct a digital communications check—

- (1) Press the SELF-TEST switch.
- (2) The MBC displays "MICR SW DSP MOD." The sequence indicator blinks, indicating that another choice is available.
- (3) Press the SEQ switch.
- (4) The MBC displays "XMIT TEST MSG."
- (5) Select XMIT.
- (6) The MBC displays "ROUTE: *XMIT." The route is found in the SOI.
- (7) Enter the route.
- (8) Select XMIT.
- (9) The MBC displays "XMITING."

10-3. The MBC transmits the test message to the DMD. When the DMD accepts the message, it transmits an acknowledgement (ACK). If the message is not accepted, the MBC displays "NO RESP RETRY 1." The operator should try to retransmit the message at least three times. If the message is still not accepted, the communication system should be repaired.

COMMUNICATIONS

10-4. The MBC can store a maximum of three incoming digital messages. Incoming messages are of two types: fire mission messages and information-only messages. When the message indicator is lit or the audio alarm sounds and the MSG switch is pressed, the MBC displays the first line of the first message received. When a message is a fire mission, the MBC automatically assigns mission and target numbers, unless three active missions have already been stored. In this case, the MBC displays "NO AVAIL MSN," and discards the message.

RECEIVING MESSAGES

10-5. The flashing MSG indicator tells the operator that a message has been received.

10-6. To view a message—

- (1) Select the MSG switch.
- (2) The MBC displays a heading to identify the type of message. If the message is not a fire request, the applicable data are automatically stored in the correct menu.
- (3) Select the SEQ switch.

- (4) The MBC displays the FO and net identification. The FO authentication code is displayed.
- (5) Select the SEQ switch.
- (6) Validate the code in the authentication table.
- (7) Select the SEQ switch.
- (8) Review each line of the message.

NOTE: After the FDC order has been completed, the operator clears the message from the message buffer. If the message is a fire request, the mission is automatically activated. The operator must assign the mission using the WPN/AMMO switch and compute the firing data.

TRANSMITTING MESSAGES TO OBSERVER

- 10-7. When the MBC is DMD-supported, the FO must receive an MTO and a shot/splash.
- 10-8. To prepare and send an MTO—
 - (1) Select the XMIT switch.
 - (2) Select MTO using the display key directly below the flashing cursor on MTO.
 - (3) The mission and target numbers entered by the MBC are displayed.
 - (4) Select the SEQ switch.
 - (5) The adjusting weapon is displayed.
 - (6) Select the SEQ switch.
 - (7) Enter the number of volleys to be fired.
 - (8) Select the SEQ switch.
 - (9) The number of weapons firing is displayed. The display should indicate only one weapon when adjusting.
 - (10) Select the SEQ switch.
 - (11) The probable error is displayed as "PR ERR: NOT GVN" (probable error: not given).
 - (12) Select the SEQ switch.
 - (13) The ADJ shell/fuze is displayed.
 - (14) Select the SEQ switch.
 - (15) The shell/fuze for the first round of the FFE is displayed. This was received in the fire request the FO sent.
 - (16) Select the SEQ switch.
 - (17) The shell/fuze for subsequent rounds of the FFE is displayed.
 - (18) Select the SEQ switch.
 - (19) Use the multiple choice entry to select the proper method of engagement: HI (high angle) or DC (danger close).
 - (20) Select the SEQ switch.
 - (21) The method of control (CON: WR AF) is displayed.
 - (22) Select the SEQ switch.
 - (23) The time of flight is displayed.
 - (24) Select the SEQ switch.
 - (25) The angle T is displayed.
 - (26) Select the SEQ switch.
 - (27) The mission number for the current mission is displayed.
 - (28) Select the SEQ switch.
 - (29) The FO's identification is displayed.
 - (30) Enter the appropriate route.

- (31) Select the SEQ switch.
- (32) Enter the authentication code.
- (33) Select the flashing asterisk (*) to transmit the MTO to the FO.
- (34) When the message is received, the MBC displays "ACK."

TRANSMITTING SHOT/SPLASH

10-9. To transmit the shot/splash to the FO—

- (1) Select the XMIT switch.
- (2) Use the multiple choice entry to select CMD.
- (3) The mission and target numbers are displayed.
- (4) Select the SEQ switch.
- (5) The type of firing information being sent is displayed. The MBC defaults to SHOT. Splash is automatically transmitted about five seconds before the round impacts. The operator may decide to transmit only splash by changing the display from SHOT to SPLASH.
- (6) Select the SEQ switch.
- (7) Select DIGITAL when the MBC is DMD-supported.

NOTE: Select MANUAL for the MBC to notify (with an audio warning) the operator when to orally transmit the splash. If manual is selected, the MBC displays "*SHOT." The operator presses the asterisk (*) when the round is fired. The MBC notifies (with an audio warning) the operator when to transmit the splash. The MBC displays "READY," when any key is pressed.

- (8) Select the SEQ switch.
- (9) The FO identification is displayed.
- (10) Enter the route number.
- (11) Select the SEQ switch.
- (12) Enter the authentication (COMSEC) code from the SOI to transmit SHOT.
- (13) Select the SEQ switch.
- (14) Enter the authentication (COMSEC) code from the SOI to transmit SPLASH.
- (15) Select the SEQ switch.
- (16) The MBC displays "*XMIT." When the command to fire is given, press the asterisk (*), and the shot is automatically transmitted to the FO. XMITTING is displayed until it is time to send the splash. The splash is momentarily displayed, and then XMITTING. ACK is received when the DMD accepts the message.

This page intentionally left blank.

Part Four

M16 and M19 Plotting Boards

Chapter 11

Introduction

M16 and M19 plotting boards are the secondary means of fire control for all forms of digital mortar fire control. Using these tools, the computer can determine deflections, azimuths, and ranges.

CAPABILITIES

- 11-1. Computers use plotting boards when determining azimuths, deflections, and ranges.
- The computer determines the azimuth by rotating the azimuth disk to the correct alignment.
 - Before the deflection can be determined, the computer must establish a mounting azimuth and index the referred deflection.
 - Range is determined by measuring the distance between the plotted mortar position and the plotted target. M16 and M19 plotting boards use different scales for determining range.

NOTE: See Chapter 12 for more information about the different scales for determining range.

CAUTION

When plotting on the plotting board, use a soft lead pencil. NEVER use map pins, needles, ink pens, or grease pencils since these can damage the board.

11-2. The straightedge of the plotting board should always be on the computer's right. Each plot is circled and numbered for identification. To avoid distortion, the computer should place his eye directly over the location of a plot and hold the pencil perpendicular to the board. The plot should be so small that it is difficult to see. The computer must be careful when placing a plot on the disk, since a small plotting error could cause the final data to be off by as much as 25 meters in range and more than 10 mils in deflection. For example, to determine azimuths—

- (1) Read the first three numbers from the azimuth disk, left of the index mark.
- (2) Read the fourth number, or the last mil, using the azimuth disk and the right side of the vernier scale (Figure 11-1).

EXAMPLE

Consider azimuth 3033 in Figure 11-1. The first and second numbers are the first 100-mil indicator to the left of the index mark (30). To obtain the third number, count the 10-mil graduations between the 100-mil indicator and the index mark (3). The fourth number, or the last mil, is read by counting the 1-mil graduations from 0 to the right on the vernier scale until one of the 1-mil graduations align with one of the 10-mil graduations on the azimuth disk (3).

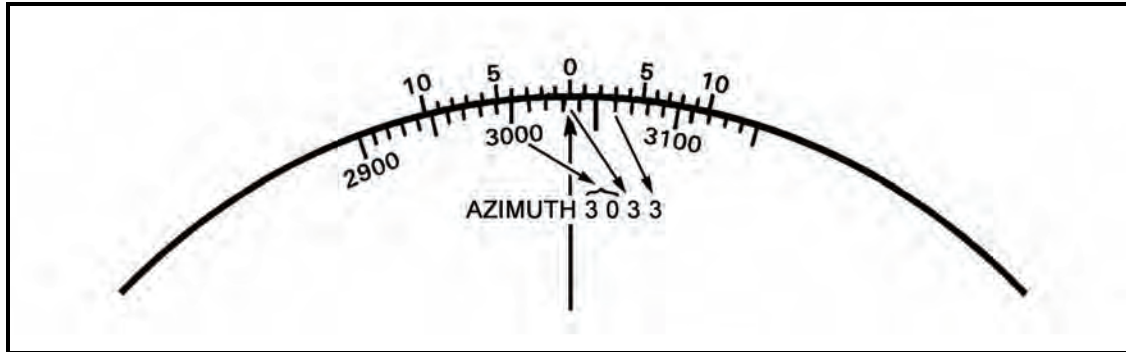

Figure 11-1. Vernier scale.

M16 PLOTTING BOARD

11-3. The M16 plotting board is the secondary means of fire control for 81-mm and 120-mm mortars. It consists of a base, azimuth disk, and a range arm or range scale arm (Figure 11-2).

BASE

11-4. The base is a white plastic sheet bonded to a magnesium alloy backing. The grid system printed on the base is to a scale of 1:12,500, making each square 50 meters by 50 meters and each large square 500 meters by 500 meters. At the center of the base is the pivot point to which the azimuth disk is attached. Extending up and down from the pivot point is the vertical centerline. The vertical centerline range scale is graduated every 50 meters and numbered every 100 meters from 0 (pivot point) to 3,100 meters, with a total range from the pivot point of 3,200 meters. The vertical centerline ends with an arrowhead at the top of the board.

11-5. The arrowhead, known as the index mark pointer, is used in determining azimuths and deflections to the nearest 10 mils. It points to the index mark of the vernier scale (0 mark), which is used to determine azimuths and deflections to the nearest mil. The vernier scale is divided every mil and numbered every 5 mils, with a total of 10 mils left and right of the 0.

11-6. To the left of the vertical centerline is the secondary range scale. The secondary range scale is numbered every 500 meters (from 0 to 6,000), with a total range of 6,400 meters. It is used to determine range when the mortar position is plotted at points other than the pivot point. Two additional range scales; 1:50,000 and 1:25,000; are on the right edge of the base. They are used with maps in determining ranges.

AZIMUTH DISK

11-7. The azimuth disk, made of clear plastic, is roughened on one side so that it can be written on with a soft lead pencil. The azimuth scale on the outer edge is numbered every 100 mils (from 0 to 6300) and divided every 10 mils with a longer line at every 50 mils, giving a complete circle of 6400 mils.

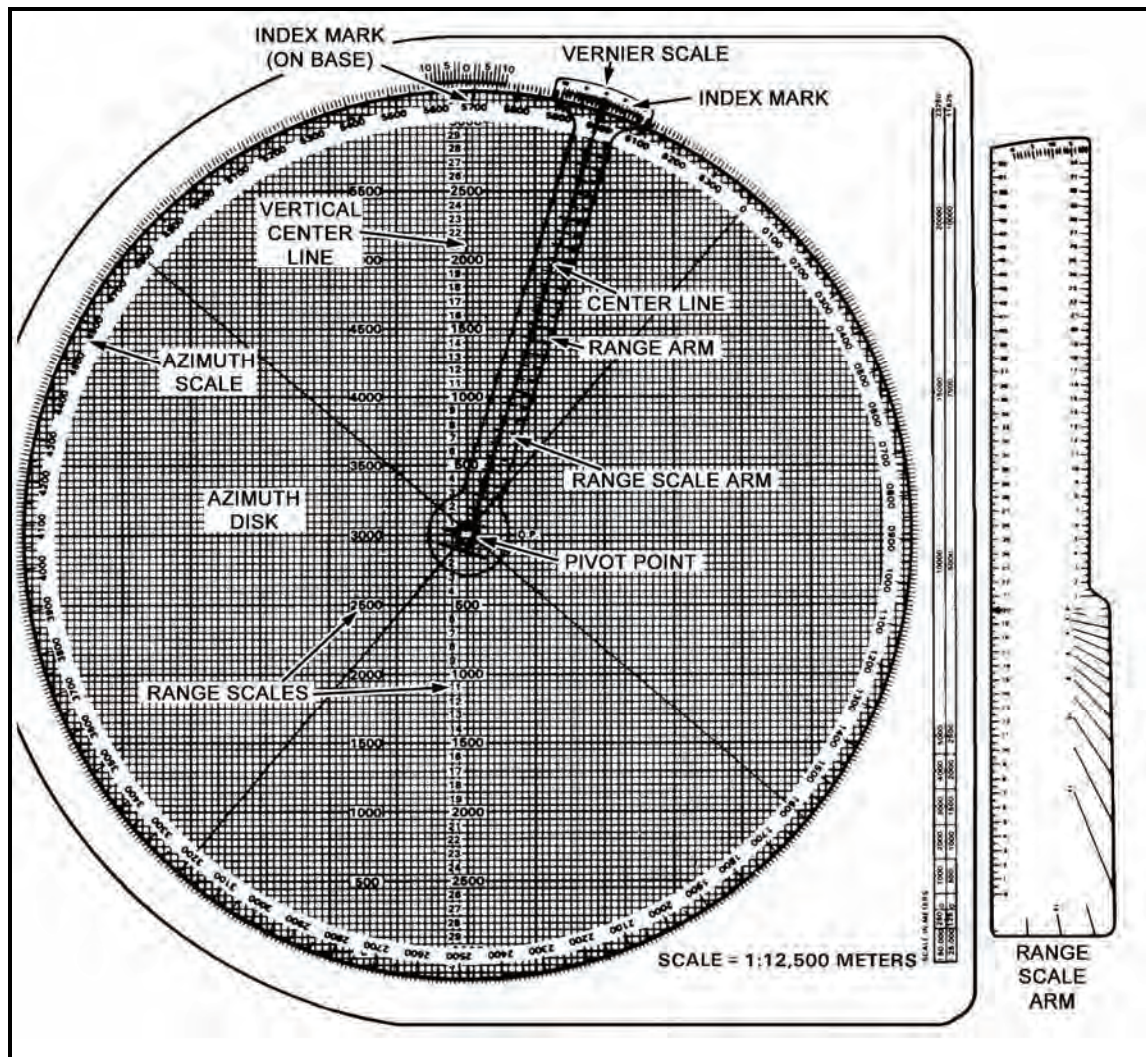

Figure 11-2. M16 plotting board.

RANGE ARM

11-8. Made of plastic, the range arm is used when the mortars are plotted at the pivot point. The arm has a vertical centerline with a range scale and a vernier scale, both of which are the same as on the base.

RANGE SCALE ARM

11-9. The range scale arm, a transparent plastic device, has a knob with a pivot pin, two range scales (one on each edge), a protractor on the right bottom, and a vernier scale across the top. The range scales are numbered every 100 meters and graduated every 50 meters. The protractor is graduated every 100 mils from 0 to 1600 mils.

M19 PLOTTING BOARD

11-10. The M19 plotting board is the secondary means of fire control for the 60-mm mortar. It consists of a rotating disk of transparent plastic and a removable range arm, both attached to a flat grid base (Figure 11-3).

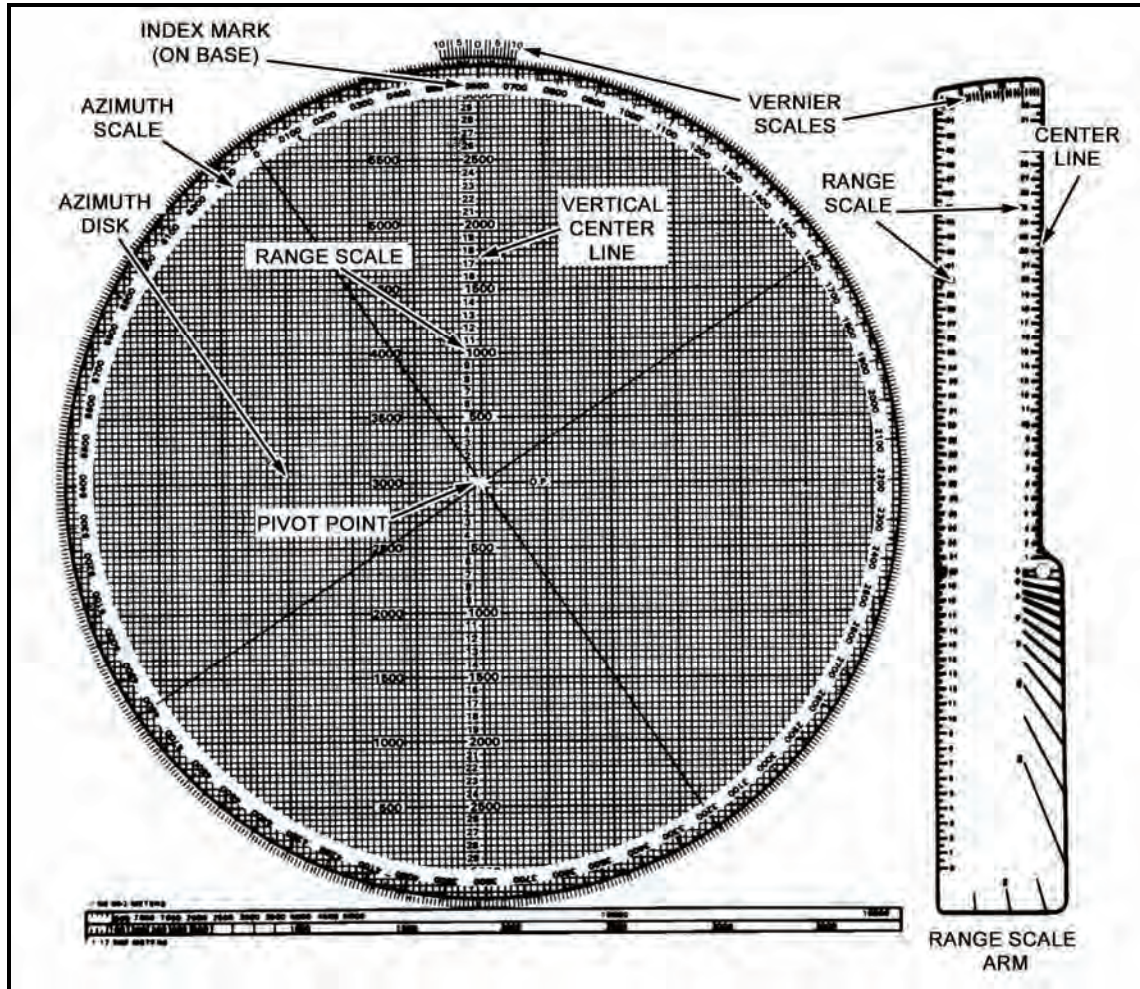

Figure 11-3. M19 plotting board.

BASE

11-11. The base is a white plastic sheet bonded to a magnesium alloy backing. A grid is printed on the base (in green) at a scale of 1:25,000. The vertical centerline is graduated and numbered up and down (from 0 through 32) from the center (pivot point) in hundreds of meters, with a maximum range of 3,200 meters. Each small grid square is 100 meters by 100 meters.

11-12. The index mark points to the center of the vernier scale at the top edge of the plotting board. It is the point at which deflections or azimuths may be read to the nearest 10 mils. When plotting at the pivot point, the pivot point represents the location of the No. 2 mortar.

11-13. In addition to the grid pattern, a vernier scale is printed on the base. It is used to obtain greater accuracy when reading the mil scale on the azimuth disk. The vernier scale permits the operator to read azimuths and deflections accurately to the nearest mil.

11-14. On the bottom of the base, a double map scale in meters with representative fractions of 1:50,000 and 1:12,500 is used to transfer to and from a map that has one of those scales.

AZIMUTH DISK

11-15. The rotating azimuth disk is made of plastic. Its upper surface is roughened for marking and writing. A mil scale on the outer edge is used for plotting azimuths and angles. It reads clockwise to conform to the azimuth scale of a compass. The scale is divided into 10-mil increments (from 0 to 6400) and is numbered every 100 mils. Also, the disk has two black lines called centerlines. These centerlines are printed across the center of the disk from 0 to 3200 and from 1600 to 4800 mils.

RANGE SCALE ARM

11-16. The range scale arm is used when mortars are plotted at the pivot point. It is made of plastic and can be plugged into the pivot point. Two range scales are on the range scale arm. On the right edge is a range scale that corresponds to the range scale found on the vertical centerline. An alternative range scale ranging from 0 to 6,000 meters is on the left edge of the range scale arm and is used when plotting away from the pivot point. The vernier scale at the upper end of the range scale arm is used to read azimuths or deflection when plotting at the pivot point without rotating the disk back to the vertical centerline. The direction of the FO can be indexed at the index point. The vernier scale on the range scale arm is read in reverse of the one on the grid base. The left portion is read for azimuth, and the right portion is read for deflection. The protractor lines below the range scale arm knob may be used to place a sector of fire on the disk.

- To read the azimuth to 1 mil, read the left portion, starting at 0, and read to the 10 in the center.
- To read deflections, start at the right edge of the range scale arm and read to 10.

This page intentionally left blank.